

ZM223 Weight Indicator



User Manual

AWT35-100201

Issue AD

Avery Weigh-Tronix is a trademark of the Illinois Tool Works group of companies whose ultimate parent company is Illinois Tool Works Inc (“Illinois Tool Works”). Copyright © 2026 Illinois Tool Works. All rights reserved. No part of this publication may be reproduced by making a facsimile copy, by the making of a copy in three dimensions of a two-dimensional work and the making of a copy in two dimensions of a three-dimensional work, stored in any medium by electronic means, or transmitted in any form or by any means, including electronic, mechanical, broadcasting, recording or otherwise without the prior written consent of the copyright owner, under license, or as permitted by law. This publication was correct at the time of going to print, however Avery Weigh-Tronix reserves the right to alter without notice the specification, design, price or conditions of supply of any product or service at any time.

Table of Contents

Table of Contents	3
Manual Revision History	5
1 General Information and Warnings	7
1.1 About this Manual	7
1.2 Text Conventions	7
1.3 Special Messages	7
1.4 Installation	7
1.5 Routine Maintenance	8
1.6 Equipment Operation	8
1.7 Cleaning the Indicator	9
1.8 Training	9
1.9 Sharp Objects	9
1.10 FCC and EMC Declarations of Compliance	9
2 Introduction	10
2.1 Front Panel	11
2.2 App Specific Function	12
2.3 RPN Key Functions	12
2.4 Front Display	13
2.5 Annunciators	14
2.6 Powering Up the ZM223	14
3 Basic Operations for General Weighing	16
3.1 Zero	16
3.2 Gross Weighing	16
3.3 Tare	16
3.4 SELECT Key Function	18
3.5 Operator ID Entry	18
3.6 Printing	18
3.7 Available Communication Ports	19
3.8 Entering Alphanumeric Characters	19
3.9 Entering a Negative Number or a Decimal Point	20
3.10 Base Switching Mode	20
3.11 Selecting a Unit of Measure	21
3.12 Using PLUs	21
3.13 Recalling Saved PLUs	21
3.14 Viewing PLU Data	22
3.15 UDF Fields Not Linked to the PLU Database	22
3.16 Remote Assist Mobile Application	22
3.17 Remote Assist Homepage Breakdown	23
3.18 ZM223 Web Browser Page	24
4 ZM223 Indicator Applications	25
4.1 General Weighing Application	26
4.2 Accumulator Application	28
4.3 Basic Truck In & Out Application	32
4.4 Counting Application	38
4.5 Checkweighing Simple-Level Application	46
4.6 Checkweighing Mid-Level Application	50
4.7 Checkweighing Advanced-Level Application	57
4.8 Checkweighing by Percentage	66
4.9 Batching Application	73
4.10 Peak Hold Application	79
4.11 Remote Display Application	82
4.12 In-Motion Application	84
4.13 Grading Application	87

4.14	AutoLoc Application	92
5	Remote Assist Mobile App Walkthrough	95
5.1	Remote Assist Mobile App Breakdown	95
5.2	Downloading the Remote Assist Application	96
5.3	Connecting a Scale	96
5.4	Mobile App Screen Navigation	97
5.5	Scale & UDF Fields Seen in the Remote Assist Mobile App	97
5.6	Using the Active Scale Fields from the Remote Assist Mobile App	97
5.7	Text Prompt Messaging	98
5.8	Mobile App Settings	99
5.9	Customizing Home Screen Keys	99
6	Web Browser Walkthrough	100
6.1	Using the Web Browser	101
6.2	Live Weight	101
6.3	Web Browser Page Supervisor Tab	102
6.4	Mobile and Web Browser Operator Prompts	102
6.5	Viewable Data Fields for Mobile and Web Browser Pages	103
6.6	UDF Printable Fields	103
7	Menus	104
7.1	Accessing Menus	104
7.2	Menu Annunciators	104
7.3	Exiting Menu	106
7.4	User Menu	106
7.5	About Menu	114
7.6	Audit Menu	123
8	Supervisor Menus	126
8.1	General App Supervisor Menu	127
8.2	Accumulation Supervisor Menu	138
8.3	Truck In & Out App Supervisor Menu	142
8.4	Counting App Supervisor Menu	152
8.5	Checkweighing Simple-Level App Supervisor Menu	158
8.6	Checkweighing Mid App Supervisor Menu	162
8.7	Checkweighing Adv App Supervisor Menu	169
8.8	Check Percentage App Supervisor Menu	176
8.9	Batching App Supervisor Menu	182
8.10	Remote Display Supervisor Menu	187
8.11	In-Motion App Supervisor Menu	194
8.12	Grading App Supervisor Menu	198
8.13	AutoLoc Setup	200
8.14	PLUs	201
8.15	Battery	204
8.16	RPN	206
8.20	Mobile	207
8.21	App Info	208
9	Communications	209
9.1	Default Print Formats	209
9.2	Error Messages	221
10.	Technical Illustrations	222
10.1	Desktop Indicator	222
10.2	Panel Mount Indicator	223

Manual Revision History

Current Issue	Date Created	Details of Changes
AA	Aug 2025	New Manual
AB	Jan 2026	Added in a Declaration of Conformity, Pannel Mount Diagrams, and new Auto Loc Application. Updated app Operation and Setup Sections for Mid Check app, Adv Checks, Percent, Remote Display, Grading, Truck IO.
AC	Feb 2026	Added in Panel Mount Model images and edited descriptions to include the Panel Mount.
AD	May 2026	General formatting and clarity edits.

1 General Information and Warnings

1.1 About this Manual

This manual is divided into sections by the section number and the large text at the top of a page. Subsections are labelled using the 1.1 and 1.1.1 convention. The page numbers appear at the bottom of the pages in the “Page x of y” format.

1.2 Text Conventions

Key names are shown in bold and in all capital letters: **F1, SELECT, PRINT, etc.**

If a key has dual functions (RPN keys), the key name will be followed by a / and the RPN function. For example, the SAMPLE function for the counting app is linked to the F1 key so it would appear in the manual as **F1/SAMPLE**.

Navigational keys are displayed using directional arrows: ▲, ▼, ◀, and ▶

The indicator's **ENTER** key is displayed as ↵.

Displayed messages appear in bold type and reflect the case of the displayed message.

1.3 Special Messages

Special messages used in this manual are defined below. The heading words have specific meanings to alert users to additional information or the relative level of hazard.



ELECTRICAL WARNING!

THIS IS AN ELECTRICAL WARNING SYMBOL.

ELECTRICAL WARNINGS MEAN THAT FAILURE TO FOLLOW SPECIFIC PRACTICES OR PROCEDURES MAY RESULT IN ELECTROCUTION, ARC BURNS, EXPLOSIONS OR OTHER HAZARDS THAT MAY CAUSE INJURY OR DEATH.



WARNING!

This is a Warning symbol.

Warnings mean that failure to follow specific practices and procedures may have major consequences such as injury or death.



CAUTION!

This is a Caution symbol.

Cautions give information about procedures that, if not observed, could result in damage to equipment or corruption to and loss of data.



Note: This is a Note symbol. Notes give additional information about the product.

1.4 Installation



THE ZM223 DOES NOT CONTAIN USER-REPAIRABLE PARTS. REQUEST REPAIRS FROM QUALIFIED PERSONNEL.



WARNING!

Indicators with CLASS I construction must be connected to the electrical outlet with a protective ground connection.

**WARNING!**

Batteries (battery pack or installed batteries) should not be exposed to excessive heat, such as sunlight, fire, or similar sources.

The ZM223 comes fitted with an AC power cable and it must be powered by an electrical outlet with a protective ground connection (100-240 VAC, 50/60Hz, 0.5A). To turn on the indicator, connect the power cable to the electrical outlet. The indicator will turn on automatically if it is configured (or alternatively, if the automatic shut-off function is active, the power button must be pressed to fully power on the indicator). Ensure that the plug is installed near the equipment and be easily accessible.

1.4.1 Proper Grounding of Cables

For the stainless-steel desktop models, cable shield wires must be grounded directly to the studs provided at the bottom of the enclosure close to the strain relief entry point.

1.4.2 Safe Handling of Equipment with Batteries



CAUTION: Danger of explosion if the battery is incorrectly replaced. Replace only with the same or equivalent type recommended by the manufacturer. Dispose of used batteries according to the manufacturer's instructions.

1.4.3 Wet Conditions

Under wet conditions, the power supply plug must be connected to the final branch circuit via an appropriate socket/receptacle designed for washdown use.

Installations within the USA should use a cover that meets NEMA 3R specifications as required by the National Electrical Code under section 410-57. This allows the unit to be plugged in with a rain tight cover fitted over the plug.

Installations in Europe must use a socket which provides a minimum of IP56 protection to the plug/cable assembly. Ensure that the degree of protection provided by the socket is suitable for the environment.

1.5 Routine Maintenance

This equipment must be routinely checked for proper operation and calibration. Application and usage will determine the frequency of calibration required for safe operation.

Always turn off the indicator and isolate it from the power supply before starting any routine maintenance to avoid the possibility of electric shock.

1.6 Equipment Operation

The operation of this equipment is subject to the following two conditions:

1. This equipment or device may not cause harmful interference.
2. This equipment or device must accept any interference. Including the one that may cause unwanted operation.

La operación de este equipo está sujeta a las siguientes dos condiciones:

1. Es posible que este equipo o dispositivo no cause interferencia perjudicial.
2. Este equipo o dispositivo debe aceptar cualquier interferencia. Incluyendo la que pueda causar su operación no deseada.

1.7 Cleaning the Indicator



DO	DO NOT
Wipe down the outside with a clean cloth, moistened with water and a small amount of mild detergent.	Attempt to clean the inside of the indicator.
Spray the cloth when using a proprietary cleaning fluid.	Use harsh abrasives, solvents, scouring cleaners, or alkaline cleaning solutions.
	Spray any liquid directly on to the display windows.

1.8 Training

Users must not attempt to operate or complete any procedure on this indicator unless they have received the appropriate training or read the instructions.

To avoid the risk of RSI (Repetitive Strain Injury), place the indicator on a surface which is ergonomically satisfactory to the user. Take frequent breaks during prolonged usage.

1.9 Sharp Objects

Do not use sharp objects such as screwdrivers, knives/boxcutters, or pens to operate the keys.

1.10 FCC and EMC Declarations of Compliance

United States

This equipment has been tested and found to comply with the limits for a Class A digital device, pursuant to Part 15 of the FCC Rules. These limits are designed to provide reasonable protection against harmful interference when the equipment is operated in a commercial environment. This equipment generates, uses, and can radiate radio frequency energy and, if not installed and used in accordance with the instruction manual, may cause harmful interference to radio communications. Operation of this equipment in a residential area is likely to cause harmful interference in which case the user will be required to correct the interference at his own expense.

Canada

This digital apparatus does not exceed the Class A limits for radio noise emissions from digital apparatus set out in the Radio Interference Regulations of the Canadian Department of Communications.

Le présent appareil numérique n'émet pas de bruits radioélectriques dépassant les limites applicables aux appareils numériques de la Classe A prescrites dans le Règlement sur le brouillage radioélectrique édicté par le ministère des Communications du Canada.

European Countries

WARNING: This is a Class A product. In a domestic environment, this product may cause radio interference in which the user may be required to take adequate measures.

2 Introduction

The ZM223 is a robust yet easy-to-use weight indicator ideal for both indoor and outdoor use. ZM223s comes in either a desktop stainless steel model housed in an IP69K enclosure or a panel mount model with an IP66 enclosure, with a large 1.5" high digit 14 segment HTN LCD display with a 4-color backlight (green, yellow, red, and orange), and a chemical resistant numeric keypad.

The indicator has one USB port, two RS232 serial COM ports, an Ethernet port, and Bluetooth connectivity. Using these options, the ZM223 can connect to USB flash drives, printers, remote displays, computers, PLCs, mobile devices, and other peripheral devices via USB, Ethernet, serial, or Bluetooth connections.

Available options are Analog Output and Severe Transient Voltage Suppression (desktop model only) module ideal when connected to large outdoor platforms that may be at risk of lightning strikes. This indicator also has six onboard logic level setpoints that can be set either as inputs or outputs. See the Specification literature for a full list of specifications.







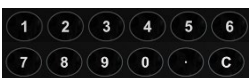

Figure 2.1 Front panel of the ZM223

2.1 Front Panel

The ZM223 front panel consists of a display and 19 keys. Never press a key with anything but a finger. Using a sharp or rough object to press a key will cause damage to the overlay.

The normal function of the keys on the front panel are listed below. Some keys will have special functions in certain applications. Details are provided in the individual application sections. In some operator and supervisor menus there is a need to navigate up, down, left and right. When in these menus follow the arrows in the blue area of the keys to allow users to move around the menu area.

Key	Function
	<ul style="list-style-type: none"> Press the TARE key to perform a tare function. Acts as the up-arrow key for menu navigation.
	<ul style="list-style-type: none"> Press the SELECT key to toggle between the active display values. Acts as the down arrow key for menu navigation. Allows users to access minus and comma signs. Press and hold to enter the setpoint editor.
	<ul style="list-style-type: none"> Press the ZERO key to zero the display/scale.
	<ul style="list-style-type: none"> Press the PRINT key to send information to a peripheral printer through one of the available communication ports. Acts as the left arrow key for menu navigation. Performs accumulator function when enabled.
	<ul style="list-style-type: none"> Press the UNITS key to cycle through the available units of measure while in normal operating mode. Acts as the right arrow key for menu navigation.
	<ul style="list-style-type: none"> Press the F1 key to perform the application specific function setup within the current app. For example, F1 acts as the SAMPLE key in the Counting app, the IN/OUT key in the Truck app, START/STOP key in the filling app, or the TARGET key in the Checkweigh app. Press to abort a numeric entry and acts as the ESCAPE key in the menu navigation. Press and hold to view the password entry screen for menu access.
	<ul style="list-style-type: none"> Press the ENTER key to accept a displayed value or function. Press and hold to enter Standby Mode. Press ENTER key when the indicator is in Standby Mode to turn on the indicator. Press the ENTER key to accept a displayed value or function.
	<ul style="list-style-type: none"> Use the numeric keypad to enter numbers in the appropriate screens. Press the C (CLEAR) key to clear the last entry. Entering in a number followed by the RPN activation key allows a second function to be activated by the key.

- **RPN extra key function.** If an RPN function is activated per key, this allows that key to perform a second function. Like ID, Preset Tare, Accumulator channel, PLU Select, Base switching, Piece weight entry, Target weight, under, over, print format, or Setpoint target values.

2.2 App Specific Function

The **F1** key is the single app specific key. This **F1** key function will change based on software application that is running within this indicator. Dedicated key labels can be used to cover the **F1** key to help operators better use this indicator.

2.3 RPN Key Functions

An RPN function is a way to use a single key for two different functions. RPN functions can be assigned to the **SELECT**, **PRINT**, **UNITS**, **F1**, and **ENTER** keys. The available RPN functions are subject to the app that is running. Users must enter a number with the indicator's numeric keys followed by pressing the correct RPN key to activate the RPN function. For more information about these RPN functions see the application sections below. These functions can be enabled or disabled under the supervisor menu under RPN.

	Application												
	General	Accum	Count	Check Simp	Check Mid	Check Adv	Check Grade	Check by %	Truck In/Out	Batch -ing	P-Hold	Remote Display	In-Motion
Tare	X	X	X		X	X	X	X	X	X	X	X	X
Base	X	X	X	X	X	X	X	X	X	X	X	X	X
ID	X	X	X	X	X	X	X	X	X	X	X	X	X
Print Format	X	X	X	X	X	X	X	X	X	X	X	X	X
I/O 4	X	X	X						X	X	X	X	X
I/O 5	X	X	X						X	X	X	X	X
I/O 6	X	X	X						X	X	X	X	X
Accumulation Channel		X											
Preact 4										X			
Preact 5										X			
Preact 6										X			
Start										X			
Stop										X			
Truck ID									X				
Light Setting									X				
Under Segment Division				X		X		X					
Over Segment Division				X		X		X					
Under Division				X		X		X					
Over Division				X		X		X					
Target				X	X	X		X					
Target Low				X	X	X		X					
Tolerance Low				X	X	X		X					
Target High				X	X	X		X					
Tolerance High				X	X	X		X					
Piece Weight			X										
Sample Size			X										
PLU			X			X		X					

Available RPN Functions



Note: Every ZM223 comes with a key label pack to place over a key or annunciator so it is correctly labeled.

2.4 Front Display

The default backlight color for the General Weighing app is Green however the backlight color can be changed by the operator from the User Menu under the **BackLt** submenu (see [page 110](#)).

The available Backlight colors are Green, Red, Yellow, and Orange.

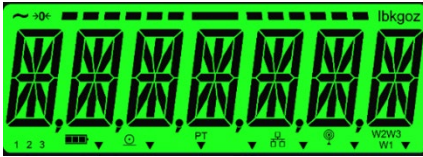

Green

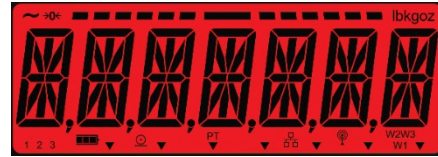

Red

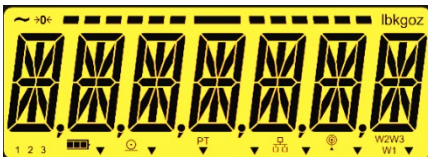

Yellow

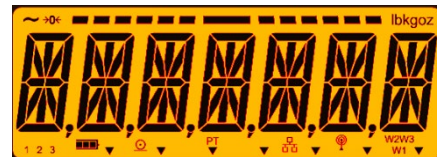

Orange

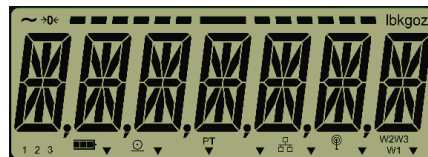

Backlight Off

Depending on the app in use that is running backlight color may vary. For example, when using the Checkweighing app backlight colors can represent when a weight is within the low window, accept window, high window.

In most apps, the backlight color is controlled by the app and can be changed from within the supervisor menu.

Users can adjust the backlight brightness and contrast holding the **F1** (brightness) or **UNITS** (contrast) key and use ▲ and ▼ to adjust the settings. The brightness and contrast are saved automatically and will be applied after a reboot.

2.5 Annunciators

These annunciators will light during operation to inform the user of the weighing mode, active unit of measure, etc. The annunciators on the display are shown below

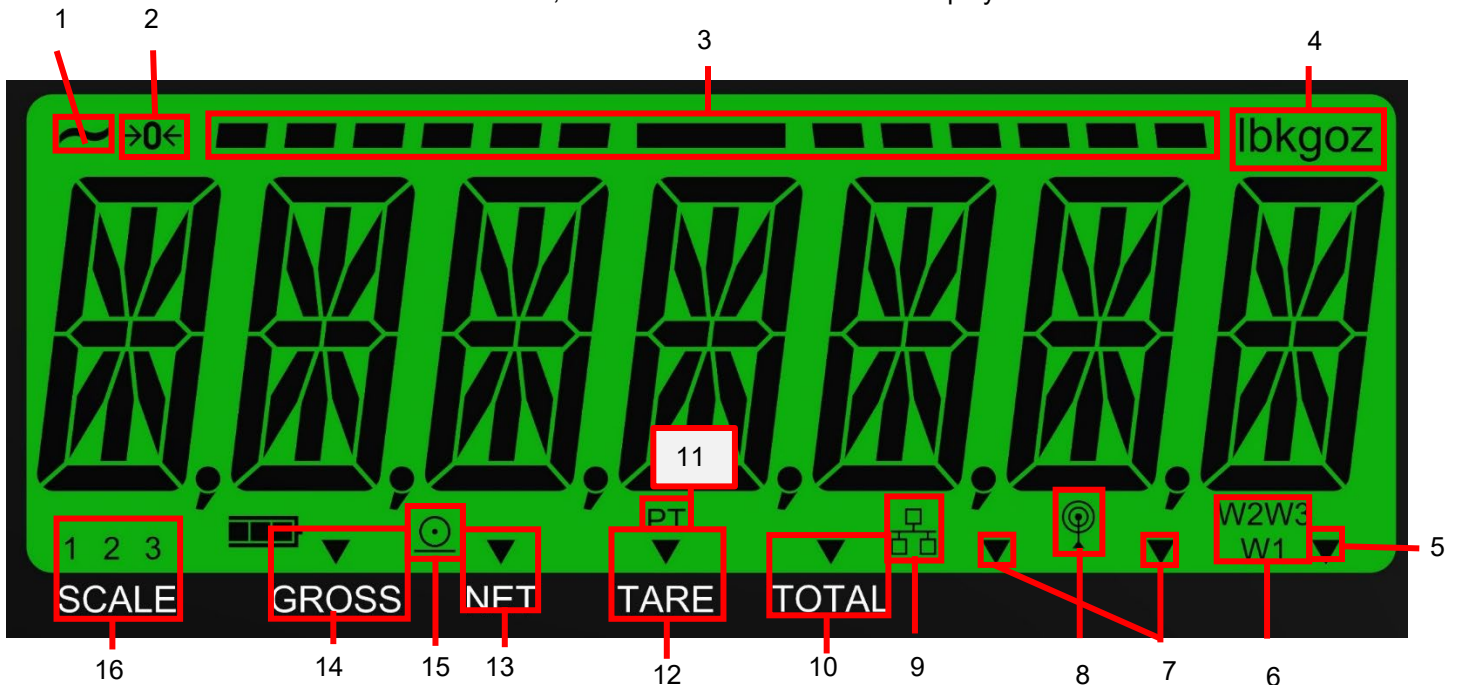

Number	Annunciator	Number	Annunciator
1	Motion	9	Ethernet Connection
2	Center Zero	10	Total
3	Under Over Accept Bar Graph	11	Preset Tare
4	Units of Measure (lb,kg,& oz)	12	Tare
5	Custom Unit of Measure	13	Net
6	Weight Ranges 1 to 3	14	Gross
7	2 Custom App Driven	15	Print
8	Bluetooth	16	Scale Number

2.6 Powering Up the ZM223

The ZM223's power setting can be configured two ways, **Always On** or **Front Panel ENTER/POWER Key**.

Always On (default)

Once the indicator is connected to a power supply it will automatically power up and remain on until the power source is removed.

Front Panel ENTER/POWER Key

With the indicator connected to a power source the indicator will only power up if the **ENTER/POWER** key is pressed. Once pressed, the indicator will turn on and display a Gross weight reading. To use this feature, contact your service provider.

Turning Indicator Off

If the indicator is configured to use the **ENTER/POWER** key to power down the indicator, press and hold the **ENTER/POWER** for 5 seconds. Once pressed, the display will show a

count down from 5 to 0 before turning off. If the **ENTER/POWER** key is released before the 5 seconds are up, the indicator will revert to normal operation.

Power Supply Used in the ZM223

- **Desktop AC power** cord connected to a properly grounded outlet (100 VAC – 240 VAC, 50 or 60 Hz)
- **Panel Mount: External 12-24 VDC @ 1.2 Amps up to 28VDC @400mA (14.4 Watts).** These are the power requirements for a fully loaded unit (8 x 350. load cell, 500mA out the 5V COM port terminal block, 500mA load on USB Host).
- **External 24VDC** battery pack connection. Recharging the battery pack must be done away from the indicator to avoid damage.
- If fully powered from a DC power source, like a battery, there are extra power saving features to help prolong battery life found in the Supervisor Menus. An **Auto shutoff** feature can be activated to automatically turn off the indicator when there are long periods of inactivity (see [page 200](#) for setup).

3 Basic Operations for General Weighing

3.1 Zero

Whenever there is no weight on the scale base, but the indicator displays any value other than 0, press the **ZERO** key to reset the indicator and scale base to 0.

3.2 Gross Weighing

To perform gross weighing, power up the indicator and follow these steps:

1. Empty the scale and press **ZERO** to zero the scale ...
0 is now displayed and the center-of-zero GROSS annunciator lights up.
2. Place the item to be weighed on the scale...
The item's weight is now displayed.
3. Remove the item from the scale.
4. Repeat steps 2 and 3 for each new item to be weighed.

3.3 Tare

Designed to remove or "tare-off" the weight of a container on this scale so only the goods/items inside the container are weighed. The weight of goods placed inside the container are displayed as a Net weight. Press the **SELECT** key to toggle the display between the Gross, Net, and Tare weighs.

Net Weighing

Net weighing allows users to see the weight of item/items without the weight of the container holding them factored in. Net Weighing is available via three types of tare entry push button tare, key in tare, and preset tare.

1. With "Push button tare" enabled and the empty container on the scale, press **TARE** to tare the weight of the container off the scale.
2. With "key in tare" enabled, key in a tare weight and press **TARE** to set.
3. With "preset tare" enabled, press **TARE** to recall a preset tare numbered 1-10.



Note: Pushbutton and Entered Tares can be enabled simultaneously. If Preset Tare is enabled, Pushbutton is automatically disabled.

There is an "auto tare clear" feature. If this is enabled, after a weighment and the weight falls into the gross zero band, the tare is automatically cleared to show a Gross Zero weight.

Using Pushbutton Tare

To perform a net weighment using Pushbutton Tare, power up the indicator and follow these steps:

1. If the display does not read 0 with nothing on the scale press **ZERO** ...
0 is now displayed and the center-of-zero annunciator lights.
2. Place item to be tared-off on the scale (often a container) ...
Weight is now displayed.
3. Press **TARE** ...
0 is now displayed and the Net annunciator lights up.
4. Place material to be weighed into or on the tared item on the scale ...
Net weight of material is now displayed.

5. Repeatedly press **SELECT** to cycle the Gross, Tare, and Net values.
6. If repeated weighments use the same tared item, do not establish a new tare value as described in step 2 and 3.

Using Entered Tare

To perform a Net weighment using Entered Tare, power up the indicator and follow these steps:

1. If the display does not read **0** with nothing on the scale, press **ZERO ...**
0 is now displayed and the center-of-zero annunciator lights.
2. Key in the tare weight value of the container used to hold the items being weighed and press **TARE ...**
Tare weight is now displayed as a negative value and the Net annunciator lights up.
3. Place the container and materials on the scale...
Net weight of the items is now displayed.
4. For repeated weighments using the same tared item, do not establish a new tare value as described in step 2.
5. To remove the tared weight from the scale, enter **0**, then press **TARE...**
The tare is cleared, and the scale will return to Gross weigh mode.

OR

Press and Hold the **TARE** key until **Cleared** is displayed...The display will switch back to Gross weight mode.

Using Preset Tare

The ZM223 can save up to 10 tares (numbered 1-10) in indicator. When using a Preset tare PT will be displayed on the indicator's display. Preset Tares must be entered within the Supervisor Menu. It is best practice to ensure the scale is at Gross Zero prior to entering in a new preset tare.

To perform a Net weighment using one of the preset tares, follow these steps:

1. If the display does not read **0** with nothing on the scale, press **ZERO ...**
0 is now displayed and the center-of-zero annunciator lights.
2. Press **TARE ...**
The Preset Tare number entry screen is now displayed.
3. Key in the preset tare number (1-10) and press  ...
The saved Tare Weight is now displayed as a negative value and the Net annunciator lights up.
4. Place the container and material to be weighed on the scale ...
Net weight of the items is now displayed.
5. Repeat step 4 until finished using that preset tare weight.



Note: If the active unit of measure is lb-oz then tare weight must be entered in the oz equivalent. To enter 2 lb 4.5 oz enter 36.5 oz (2 lb = 32 oz plus the 4.5).

Clearing a Tare

Press and hold the **TARE** key. The scale display will be clear and the Gross annunciator will illuminate, and the Tare Annunciator will turn off.

Tare Weight Parameters

Subject to the ZM223's site location and if any metrology requirements are turned on, a Tare Boundary can be enforced, resulting in limitations to taring weights outside the set

region weight boundaries. In this case, the indicator display will display “Cant” before reverting to the previous displayed reading.

3.4 SELECT Key Function

Pressing the **SELECT** key allows users to cycle through and view the values. If an accumulation function is turned on and the scale is within the Gross Zero weight band, pressing the **SELECT** key also shows the Gross Total, Net Total, Tare Totals, Transaction Totals, and Count Total values.

- When the Gross Total is displayed, both the GROSS and TOTAL annunciators will be lit.
- When the Net Total is displayed, both the Net and Total annunciators will be lit.
- When the Transaction Count is displayed, the custom annunciator will be lit. Add the provided Transaction Count sticker to the display.

Additionally, when in normal operation the user can hold down the **SELECT** key to enter a quick edit mode for the Output Targets for Outputs 4 - 6 values. This only applies to the ZM223 Indicator Apps that allow for output configuration.

In apps that use PLU database (Counting, Check Advanced and Check PER), a long key press on the **SELECT** Key now gets you into PLU selection. From here, you can see or change what the active PLU is ([see page 21](#)).

3.5 Operator ID Entry

An Operator ID can be entered for use with transmitted or printed transactions.

This function is available in most ZM223 apps via the RPN function. When enabled, an ID can be entered by using the numerical keys followed by the assigned RPN key.

If the RPN ID function is activated, key in the required ID number up to 7-digit ID and then press the selected RPN ID key.

This ID number will now be stored within the indicator. The ID number will remain within indicator until the indicator is turned off or until a new ID number is entered.

In the General App, the operator ID is automatically assigned to the **F1** key.

1. To view the Operator ID press the **F1** key...
the current ID will be flashed on the screen.
2. To change the Operator ID, key in the new the Operator ID number and press  to accept. The indicator will now return to normal operation.

Reviewing the ID number, in all apps other than General can only be done using the Remote Assist Mobile App or the Web Browser Pages.

3.6 Printing

To print the current weight information, press the **PRINT** key. The configured print format will be outputted through the configured port to the connected peripheral device. For more on Default Print Formats refer to the complete list on [page 209](#).

Subjected to the configuration of the scale, some applications will only allow one print to be performed once the weight is stable. To perform the next print the scale needs to return to within the Gross Zero Band and weight reapplied to perform another print.

In applications that use the Accumulation function, the **PRINT** key adds the Gross Net and Tare values to the stored accumulated Totals.

If Print Total and Clear Total are enabled, a long key press on the **PRINT** key also prints out the running totals and then clears them, getting the indicator ready for the next product to be weighed.

Printing any of the configured print formats is possible using the **RPN** Print Format feature. Enter the Print Format Number, and then press the **PRINT** key. The selected print format will be transmitted out all ports that are configured to print.



*Note: Users can quick select a Print Format by using the keypad. For example, key in 1 9 and press the **PRINT** key to print a ticket using Print Format 19, 3 5 to get Print Format 35, etc.*

The ZM223 comes standard with a library of over one hundred predefined labels and ticket formats suitable for most applications, however, any of these print formats can be customized by your service provider to better meet your application requirements. Contact your service provider to customize your label formats.

Alongside the standard print formats, the ZM223 also has around 20 UDF (User definable fields) that can be used and edited by the operator to add regularly changeable data to a print label format. Examples of this data include: customers name, address, part number, description, batch number or other.

UDFs hold printable data that can be modified and amended from the Remote Assist Mobile App or the ZM223 Web Browser pages for use on print tickets or labels to add in customer required data that may change per label batch.

3.7 Available Communication Ports

To allow the ZM223 to connect to a wide range of peripheral devices like printers, remote displays, remote bases, scanners, PLCs, PC, cloud servers, USB keyboards, phones, and tablets the indicator comes standard with the following connection ports.

- 2 x RS232
- 1 x USB host
- 1 x Bluetooth
- 1 x Ethernet port (with 10 independent connections)
 - Enet / IP
 - Modbus TCP
 - FTP
 - HTTPS
 - MQTT

3.8 Entering Alphanumeric Characters

The ZM223 uses a fourteen segment 7-digit LCD display for displaying navigational menus, however due to the limited keypad it is not ideal for entering in alphanumeric text.

Entering UDF text fields data is primarily done by using the Remote Assist Mobile App or the ZM223 web browser pages. [See page 95](#) for more information.

The only alphanumeric text that can be entered in though the indicator's front panel is for the Site ID submenu found inside the User Menu.

When a text entry screen is present scroll through alphanumeric characters and symbols by pressing the ▲ or ▼ keys and move the cursor position by using the ◀ or ▶ keys. Once you have the desired character move the cursor to the next position or press  to accept the input.

3.9 Entering a Negative Number or a Decimal Point

To enter a negative number, press the C key to clear the current value from the display. With only one digit displayed press ▼. The first character will be the (-) negative sign.

Key in the rest of the digits normally and press ↵ to accept the input.

3.10 Base Switching Mode

One ZM223 indicator can run two scale bases (one analog scale base and one digital BSQ scale base or two digital BSQ bases). The active base number is always shown in the bottom left had side of the display.

When a second scale base is configured to the ZM223 users can switch between base 1 and base 2 by using a RPN function. In the General app, the Base switching RPN function is set by default to the **SELECT** Key.

To switch bases, follow the below steps:

1. Press the **2** key and then the RPN activation key (**SELECT**)...
The display's Scale Annunciator will change from 1 to 2 and the live weight will now be coming from Scale 2.
2. To switch back to Scale 1, press the **1** key and then the RPN activation key (**SELECT**)

The display's Scale Annunciator will change from 2 to 1 and the live weight will now be coming from scale 1.

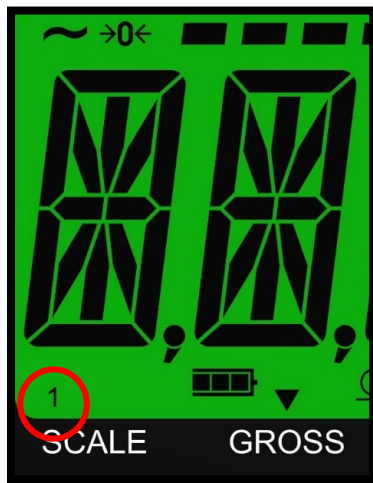

Scale 1 Annunciator

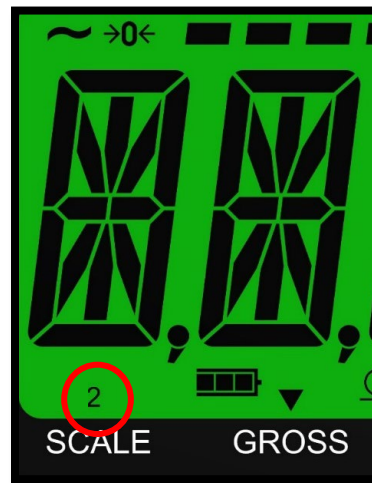

Scale 2 Annunciator



Note: Contact your service provider to connect a ZM223 to a 2nd BSQ base.

3.11 Selecting a Unit of Measure

The **UNITS** key switches between the primary units of measure the connected scale base is calibrated for (common units are lb,kg, g,oz, lb-oz, custom). The ZM223 can have up to four units of measure turned on within the scale. The Default Unites of Measure is lb and kg.

The active unit of measure is illuminated in the top right corner of the display (shown below as callout 1). In the case that the unit of measure is set to Custom, the bottom right most annunciator will be illuminated (shown below as callout 2).



3.12 Using PLUs

PLU databases are available with some applications like Counting, Checkweigh Advanced and Percentage checkweighing. When configured internally, up to 2000 PLUs can be stored on the indicator's micro-SD card.

PLUs are used to quickly recall pre-stored tares and piece weights, along with other useful parameters using a PLU Slot from (1-2000).

- Piece Weight
- Target
- Under Tolerances
- Over Tolerances

PLU 0 is a free PLU that cannot be saved over PLU1 to 2000 hold data that can be stored and recalled even after the indicator has been turned off.

Due to the indicator display limitations, neither the Part number nor Description UDF fields can be seen, entered or edited from the ZM223 front panel. These fields can only be seen when using the ZM Remote Assist mobile app or web browser page.

3.13 Recalling Saved PLUs

Recalling a PLU can be done in four ways:

- Press and Hold the **SELECT** key
 - Using RPN key function if PLU is activated.
 - Using the Remote Assist Mobile App.
 - Using the Avery Weigh-Tronix web browser page.
1. When in an app that use PLUs, press and hold the **SELECT** key to access the PLU entry screen.
 2. Key in the required PLU number and press enter  ...
The display flashes **PLU** and then displays the active PLU number as **xxx**
 3. Display now loads the required weight parameters for that PLU and waits for weight to load on the scale. If in the Counting mode, the display switches to counts, awaiting parts to be added, if in Checkweighing mode, the scale loads the High and Low weight bands, awaiting weight to be loaded on the scale.

3.14 Viewing PLU Data

The following PLU fields can be viewed from the Supervisor Menu or viewed and modified directly from the Remote Assist app or Web Browser page if these fields are activated.

- Piece Weight
- Target
- Under Tolerances
- Over Tolerances

3.15 UDF Fields Not Linked to the PLU Database

The following text UDF fields that can be called up from the indicator for use on print tickets or labels.

- ID
- Part Number
- Description
- Lot location
- Name
- Address
- 10 Free UDF text fields

These extra UDF fields are designed to allow the operator to easily add text to a known print label or ticket. These fields are not Linked to a PLU number and can be turned on or off from within the Supervisor Menu under the Mobile Field.

The UDF fields can only be entered or edited using the Remote Assist app or the Web Browser page. Enabling these fields so they are visible in the Mobile app or web browser page is done in the Supervisor Menu under Mobile ([page 207](#)).

Due to the basic display functions within this ZM223 indicator, only the Weight data fields can be entered and viewed from the supervisor menu. Any of the text UDF fields can only be viewed or changed using the ZM mobile app or the web browser page.

3.16 Remote Assist Mobile Application

There is a free Avery Weigh-Tronix Remote Assist mobile application that pairs with any ZM223 via Bluetooth. Remote Assist provides users with additional features to make the indicator more flexible.

Using the Remote Assist app users can: remotely view live weights, remote use of primary Indicator keys, view and change a wide range of app defined weight data fields, change UDF printable text fields that can be used on a print ticket or label, retrieve stored data from the ZM223 flash drive memory, store weight data to the mobile device, and use operator prompts to aid in using the ZM223.

Subject to the app running on the ZM223, special fields can be viewed and used in the Remote Assist mobile app. However, it is recommended to keep these active fields to around 6 to reduce the risk of slowing down the Remote Assist mobile app.

3.17 Remote Assist Homepage Breakdown

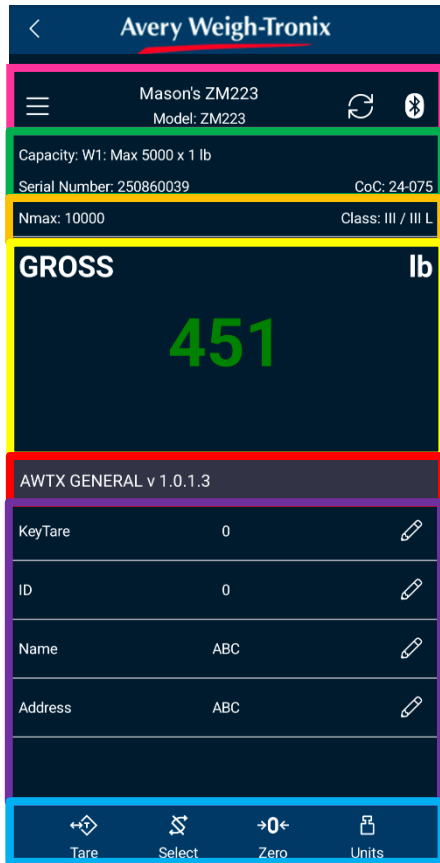

Menu button, Scale data, Refresh button, and Bluetooth icon.

Device Settings, Name, Model, Connection Type – (Firmware Driven)

Scale Device Info: Capacity, Serial Number, Etc. – (Firmware Driven)

Active Value, Weight, and Units – (Firmware Driven)

User Prompt - (App Driven)

UDF (User Defined Fields) + Custom App Buttons – (App Driven)

- Driven using LUA Variables
- Define which values you want displayed and their order.
- Variable description, value, and read/write status is show.
- Define custom buttons and colors.

Device Keys/Remote Keys – (Firmware Driven)

For additional details regarding the Remote Assist mobile app, see [page 95](#).

3.18 ZM223 Web Browser Page

This web-based application allows operators the ability to run the indicator remotely from any PC or tablet that is connected to the same network that the ZM223 through any search browser. Using the web browser app also provides the user with additional features that cannot be done directly from the ZM223 indicator.

Through the web browser app users can: remotely view live weights, use all Indicator keys, view and change a wide range of app defined weight data fields, change UDF printable text fields that can be used on a print ticket or label, retrieve stored data from the ZM223 flash drive memory, store weight data to the mobile device, and use operator prompts to aid in using the ZM223.

- To navigate between the available webpage screens (Scale, Super, and About), click on the corresponding screen button in the upper right-hand corner of the screen shown below.
- Within the web browser page users can view the active PLU allowing the operator the ability to view, edit, and adjust UDF fields. Please note that the UDF fields varies depending on the Indicator Application the ZM223 is currently running.
- To use any of the ZM223 Indicator's keys, click on the desired key on the simulated indicator display shown below.
- To edit any of the ZM223 Information Fields click on the "Edit" button to the right of the field that needs to be edited.



Note: IP address used in the web browser must match the inductors IP address. For example: 192.168.1.23

Scale

Available Webpage Screens

Scale

9.408 lb Gross

Not Legal For Trade

Usable Indicator Keys

Indicator's Info Fields

Capacity: W1: Max 40.000000 x 0.002000 lb	
AWTX In-Mo v 1.0.0.7	
ID: 67	Edit
PartNum PD158-1115674	Edit
Desc Description	Edit
Loc Scrap Area	Edit
Name Jay Armenta	Edit
Address 1000 Armstrong Drive Fairmont MN	Edit
Driver Marty Wilcox	Edit
Manager Grace Bassette	Edit
Locat Av 5987	Edit
Shift Night	Edit
ID Box 693	Edit
User No 47895	Edit
Numeric 484198	Edit
FCS No 200.500000	Edit
FL No 98745.154000	Edit
Float N 0.028481	Edit

ZM223 Series - Programmable weight indicator for advanced applications

Subject to the Site Location and the location's requirements for approval a **Not Legal For Trade** Message will display.

For additional details regarding the ZM223 web browser, see [pages 100](#).

4 ZM223 Indicator Applications

The ZM223 Indicator comes with 14 weighing applications that can be accessed from the provided SD card inside of the indicator. To access the Apps on the supplied SD card the app must be installed by the service provider when the indicator is initially installed. All ZM223's come with the General Weighing application active.

All applications are enabled through a password protected menu. Only one application can be enabled at a time.

ZM Mobile Connection: All current ZM223 applications listed below can also be used in conjunction with the Remote Assist App (see [page 95](#)).

ZM223 Web Browser Control: The ZM223 Web browser page can also be used if the indicator is connected to the same network as the PC viewing the web browser (see [page 100](#)).

Both the ZMobile app and Web browser page enhance the ZM223 functionality by allowing the operator quick access to view and change vital key printing data fields held within the ZM223 indicator.

The Available Indicator applications are:

- General Weighing (explained on [page 26](#))
- General Weighing with Accumulator (explained on [page 28](#))
- Truck In and Out (explained on [page 32](#))
- Counting (explained on [page 38](#))
- Checkweighing Simple (explained on [page 48](#))
- Checkweighing Mid (explained on [page 50](#))
- Checkweighing Advanced (explained on [page 57](#))
- Checkweighing by Percentage (explained on [page 66](#))
- Batching (explained on [page 73](#))
- Peak Hold (explained on [page 79](#))
- Remote Display (explained on [page 82](#))
- In-Motion Weighing (explained on [page 84](#))
- Grading (explained on [page 87](#))
- AutoLoc (explained on [page 92](#))













Note: All instructions concerning application setpoints are covered in the Supervisor Menu section starting on [page 128](#).

4.1 General Weighing Application

This section covers the ZM223's General Weighing application. All ZM223's come with the General Weighing application active. The General Weighing functions that are used across all apps can be found in Section 3 of this manual. Application functions that are specific to this application are explained below.

This General Weighing application can be used in a wide range of general use applications such as simple bench weighing, floor weighing, PLC, and simple filling applications.





Key	Push Duration	Function
	Press	Tares off box/container weight.
	Press and Hold	Clears Tare value
	Press	Toggles between Gross, Tare, Net, other
	Press and Hold	Access I/O 4-6 setpoints
	Press	Zeros Scale
	Press	Sends a stable weight transaction to a printer or PC
	Press	Toggles between active units of Measure lb, kg, g, oz
	Press and Hold	Enter Password Menu Area
	Press	Shows ID number
	Press	Accepts entered values

4.1.1 Special Key Functions

F1: In the General Weighing Application, the **F1** key is tied to the ID function by default. This allows users to enter, view, and edit ID numbers.

1. Press **F1** so current Operator ID is shown
2. Key in new ID number and press 

SELECT: in General weighing application if linked to any outputs to drive relays, valve gates, stack lights or alarms, pressing and holding the **SELECT** key gains quick access to the 3 output target values for **I/O4, I/O5 & I/O6**.

1. Press and hold the **SELECT** Key for 3 seconds...
SETPNT is briefly displayed, followed by **I/O4**.
2. Use  or  to move to the output that needs to be edited.
3. Press  to view target value for that set point.
A numeric entry screen is now displayed.
4. Key in new target value and press the  to accept or press **F1** to abort and move back to I/O x menu.



Note: All instructions concerning an application's Setpoints are covered in the Supervisor Menu Section on [page 128](#).









4.2 Accumulator Application

This section covers the ZM223's Accumulator application. This Accumulation app allows users to track and monitor up to 200 different running totals at the same time. This app will record the accumulated Gross, Net and transaction totals for each Accumulation Channel.

With the correct Accumulation Channel active the indicator will accumulate each Gross and Net weight after the user presses the **PRINT** key to the running total for that Accumulator channel.

Running totals per accumulator channels can be seen live using the Remote Assist Mobile App or the ZM223 web browser page.

4.2.1 Indicator Key Functions

Key	Push Duration	Function
	Press	Picks the Accumulator channel to store weight in to from 1 to 200.
	Press	Tares off box/container weight.
	Press and Hold	Clears Tare value
	Press (When the scale is at Zero)	View Gross, Net, Tare, or Transaction Totals.
	Press	Adds weight to the accumulator total.
	Press	Sends a stable weight transaction to a printer or PC.
	Press and Hold	Prints Accumulation Totals and clears Accumulation Channels
	Press	Toggles between active units of Measure lb, kg, g, oz
	Press	Enter Channel Numbers

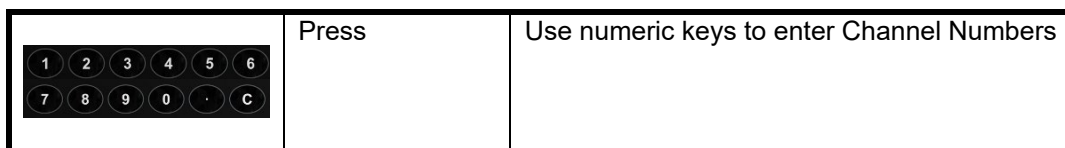

The following function can be set up as an RPN secondary key function:

- Base Switching (Default **SELECT**)
- Print Format (Default **PRINT**)
- Output 4, Output 5, and Output 6 (Default Press and Hold **SELECT** key)
- ID (Default **F1**)

4.2.2 Special Key Functions

The **F1** key controls which Accumulation Channel is accumulating. To make this easier for users to remember, the included **Chan x** key label can be placed over the **F1** key or positioned close to it to help the operator know what the **F1** key function is.

To change Accumulator Channels, follow the below steps:

1. Press **F1**...
The active accumulator channel (**chAn X**) will be briefly displayed.
2. Key in the new channel number and press 
3. The indicator will now return to normal function under the selected Accumulation Channel and will accumulate the Gross, Net, and Tare weights each time the **PRINT** key is pressed.

Pressing the **SELECT** key allows users to cycle through and view the Gross, Net, Tare, Gross Total, Net Total, and Transaction Count display values. This only applies when the scale is within the gross zero band.

- When the Gross Total is displayed, both the GROSS and TOTAL annunciators will be lit.
- When the Net Total is displayed, both the Net and Total annunciators will be lit.
- When the Transaction Count is displayed, the custom annunciator will be lit. Add the provided Transaction Count sticker to the display.

If an output is used with this application, hold down the **SELECT** key to enter a quick edit mode for the I/O 4 - 6 values. This only applies to the ZM223 Indicator Apps that allow for I/O configuration.

4.2.3 Accumulator Operation

The Accumulator Application can be used to record totals of individual weighments.

1. Prior to accumulating any totals, select an accumulator channel to accumulate weights into by pressing **F1**, entering the relevant accumulator channel number, and pressing .

OR

If starting from the beginning, press and hold the **PRINT** key to clear any existing accumulator totals...

Print Tot and then **Cleared** is displayed.

To setup the Accumulator App, follow the below steps:

2. If necessary, press **ZERO** to zero the scale ...
0 is now displayed.

3. Place item on the scale ...
The item's weight is now displayed.
4. Press **PRINT** to add more weight to the Accumulated Channel Total (each time the **PRINT** key is pressed that weight gets added to the Gross Totals, the Net Totals, the Tare Totals, and Transaction Totals) ...
The **ACC** annunciator will light up briefly.
5. Remove weight from the scale. Weight must return to inside the gross zero band before another accumulation and print can be recorded.
6. Repeat steps 2 through 4 for each weighment that needs to accumulate.



*Note: If enabled, press and hold the **PRINT** key for three seconds to print total (**Prnt Tot**) and/or clear (**Clr Tot**) will briefly appear on the screen before completing the toggled function.*



*Note: If Clear Total is deactivated in the Supervisor Menu, pressing and holding the **PRINT** key will just print the Accumulated Totals and not clear them. To clear the Accumulated Totals must be done in the Supervisor Menu under Clear Channel (**Clr CH**).*



*Note: If a tare is required place the empty box on the scale and press **TARE** key, fill the box or container with the parts to be accumulated and press the **PRINT** key. Gross, Net, and Tare weights will now be accumulated.*

4.2.4 Remote Assist Accumulator Control

Viewing and controlling the Accumulator Channels from the ZM223 Remote Assist mobile app is ideal for processes that need to be observed or controlled from a distance and for adding customer data to a ticket before printing.

All Printable text fields can be formatted to print out on a weight tickets or weight label. This can be setup by your scale service provider.

The operator or supervisor can control which accumulator channel the indicator is working in.

The Remote Assist Mobile App gives users more access to data. Some data cannot be shown on a single line indicator display without toggling between screens. Using the ZM223's companion mobile app provides all the Gross, Net, Tare, Transaction Totals along with the number of transactions all on one screen. Additionally, it allows users to clear all Accumulator Channel data once.

Below is a list of the accumulator functions that can be viewed or controlled via the Remote Assist app.

- View Live weight
- Remote Select key control function to show Gross, Net, Tare, and Transaction Totals
- Remote Accumulate Print function
- Remote Clear Channel data button
- Remote tare function



Remote Assist Accum Home Page

- Remote Zero function
- Remote unit of measure
- Remote Accumulator channel selection
- Adjustable UDF printable text function
 - Part number
 - Description
 - Loc
 - Name
 - Address
 - 5-10 Free UDF fields

All functions listed above are also available on the ZM223 Web Browser Pages when the indicator is running the Accumulation App.

The screenshot shows the web browser interface for the Avery Weigh-Tronix ZM223. At the top, there are three tabs: 'Scale', 'Super', and 'About'. The 'Scale' tab is active. On the left, there is a digital scale image with a green display showing '1324 lb Net'. Below the scale image are icons for TARE, SELECT, ZERO, PRINT, UNITS, F1, and ENTER. On the right, there is a configuration table for the Accumulation App. The table includes fields for Capacity, Serial Number, Coc, Nmax, Class, and AWTX ACCUM version. Below the table are two buttons: 'Accum' and 'Clr Tot'. The configuration table has several rows with 'Edit' buttons next to them.

Capacity: W1: Max 5000 x 1 lb	Coc: 24-075	
Serial Number: 250860024	Class: III / III L	
Nmax: 10000		
AWTX ACCUM v 1.0.0.16		
Accum Chann	1	Edit
GrossTotal	13102 lb	
NetTotal	12382 lb	
TareTotal	720 lb	
Trans Count	8	
KeyTare	240	Edit
ID	0	Edit
Name	ABC	Edit
Address	ABC	Edit

ZM223 Series - Programmable weight indicator for advanced applications

Accum Web Browser Home Page



Note: The viewable fields in the Remote Assist Mobile App and on the Web Browser Page can be controlled from within the indicator under the Mobile submenu in the Supervisor Menu.



Note: All instructions concerning an application's Setpoints are covered in the Supervisor Menu Section on [page 126](#).

4.3 Basic Truck In & Out Application

This section covers the operation of the ZM223 Truck In and Out App. The ZM223's Truck In and Out app is designed to streamline the collecting of net weights from inbound and outbound trucks. This app tracks all the inbound weights and outbound weights to determine the net transaction weight of all trucks that enter or leave the site. Fleet IDs can be stored inside the indicator with known truck tare weight to speed up the inbound/outbound process.



*Note: Operators can view the gross, net, and tare display values by repeatedly pressing the **SELECT** key.*

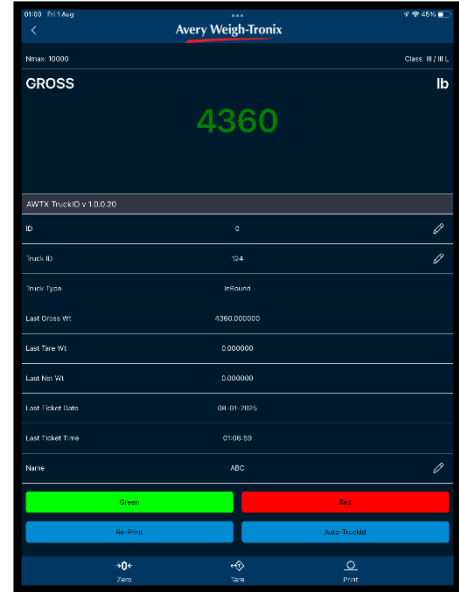



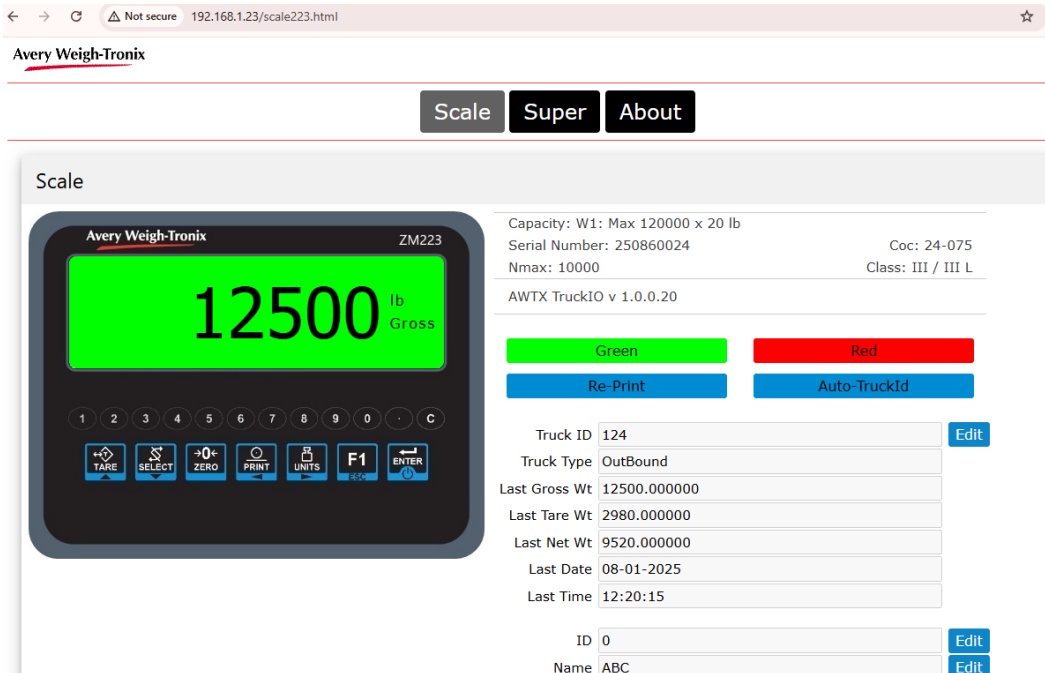







Remote Assist Truck I/O Home Page



Truck I/O Web Browser Home Page

4.3.1 Indicator Key Functions

Key	Push Duration	Function
	Press	Tares off empty truck weight. Tares are used in some manual filling applications while the truck is on the scale.
	Press and Hold	Clears Tare value
	Press	Toggle between Gross, Net, and Tare weights.
	Press and Hold	Access I/O 4, 5, and 6 values.
	Press	Zeros Scale
	Press	Sends a stable weight transaction to a printer or PC. Used for inbound and outbound applications to save weight values while printing the required inbound and outbound weight ticket.
	Press	Toggles between active units of Measure lb, kg, g, oz
	Press	Fleet key
	Press and Hold	Used to get into the Supervisor menu
	Press	Accepts entered values – turns on scale when off
C Key	Press	Exit Truck IO Transaction After entering the Truck ID, if the transaction is no longer required, press the “C” key and cLr trk is displayed to exit from the Truck IO mode.

The following function can be set up as an RPN secondary key function:

- Print Formats (Default **PRINT**)
- I/O 4
- I/O 5
- I/O 6
- ID (Default **UNITS**)

4.3.2 Special Key Functions

The following keys have an extra function in this application: Within the Truck In and Out app the **F1** key functions as Truck ID key for inbound and outbound. Dedicated key labels can be attached to the overlay to help the operator know what the **F1** key functions is now controlling. Operators can use the **SELECT** key to toggle between Gross, Net, and Tare weights.

Press F1 key: to start the Inbound or Outbound process

Press PRINT key: to print the inbound and outbound weight ticket

Press and Hold the PRINT key: to reprint the last Print ticket



4.3.3 Truck In & Out Operations

The Truck Inbound/Outbound application tracks the movements of trucks when they enter and leave a sight. This normally involves two weighments to determine the Net Weight Transaction for a truck: an Inbound Weight and an Outbound Weight.

If a truck has a known Tare Weight that is stored in the indicator as a Feet ID, it only requires one weighment to determine the Net Weight Transaction.

Inbound transaction (1st weighment)

Inbound process

1. With no weight on the scale, the truck drives onto the bridge and stops.
If the weight is over the set weight threshold of 1000 lb the backlight will turn red.
2. Press the **F1** key to start the Inbound process...
Inbound comes up on the indicator display followed by the most recently entered Truck ID (For Example: **122**). If ID Auto Generation is enabled, the Inbound Truck ID will be the next unused Truck ID (So **123** for this example).
3. To accept this Inbound Truck ID, press the  ...
The Inbound Annunciator will turn on.
4. If this is not the Truck Inbound ID that needs to be used, key in an alternative Truck ID up to 7 digits and press  ...
5. Press the **PRINT** key to finish the Inbound Transaction. An Inbound Weight Ticket will print, the Inbound Annunciator will turn off, and the backlight will change back to Green to allow the truck to drive off.

OR

If Auto Print function is enabled (Default On), once the Truck Inbound ID is accepted and the weight is stable, the Inbound Weight Ticket will print automatically, and the backlight will turn green to allow the Truck to pull off the scale.

See an example of an Inbound Weight Ticket below.

```
~~~~~  
In Date 07-21-2014  
In Time 1:21 PM  
Truck ID 123  
In Weight 18580 lb  
~~~~~
```

Outbound Process

6. With no weight on the scale, the truck drives onto the bridge and stops.
If the weight is over the set weight threshold of 1000 lb the backlight will turn red.
7. Press the **F1** key to start the Outbound process...
Inbound comes up on the indicator display followed by the most recently entered Truck ID (For Example: **214**). If ID Auto Generation is enabled, the Inbound Truck ID will be the next unused Truck ID (So **215** for this example).
8. Key in the truck's Inbound Truck ID (**123** for this example) and press  ...
If this Truck ID is found in the database, the Outbound Annunciator will turn on while the indicator calculates the truck's Net Weight from its Inbound and Outbound weights.
9. Press the **PRINT** key to finish the Outbound Transaction.

OR

If Auto Print is enabled (Default On), once the Truck ID is accepted and the weight is stable, the Outbound Weight Ticket will print automatically, and the backlight will turn green to allow the Truck to pull off the scale.

```
~~~~~  
In Date 07-21-2014  
In Time 1:21 PM  
Out Date 07-21-2014  
Out Time 2:55 PM  
Truck ID 123  
Transaction 1  
~~~~~
```

Reprint

1. To reprint the last ticket, press and hold the **PRINT** key until **Reprint** is displayed.
2. Press  ...

```
In Date 08-01-2025  
In Time 12:31:55  
ID 124  
In Weight 1980 lb
```

***** REPRINT *****

4.3.4 Truck In & Out Fleet Operations

Fleet weighments are used when a Truck has a known Truck Tare Weight stored in the indicator under a Fleet Truck ID. Fleet Trucks only need the saved Truck Weight to determine the NET weight transaction.

Use the **F1/FLEET** key for transactions involving Fleet Trucks that already have a stored tare weight.

Until a Truck ID is entered the **PRINT** key can be used for General Weighing transactions using the configured protocols. Once a Truck ID is entered the **PRINT** key will be associated with an Inbound or Outbound Ticket transaction.

Fleet Weighment process

1. With no weight on the scale, the Fleet Truck drives onto the bridge and stops.
If the weight is over the set weight threshold of 1000 lb the backlight will turn red.
2. Press **F1/FLEET** to start the Fleet Process.
Inbound comes up on the indicator display followed by the most recently entered Truck ID (For Example: **122**).
3. Key in the stored Fleet ID and press  ...
If the Fleet ID is found in the database, the display will flash **Fleet**
4. Press the **PRINT** key to complete the Fleet Transaction.
A Fleet Ticket will print, and the backlight will turn green to allow the Fleet Truck to drive off the scale.

4.3.5 USB Keyboard Key Assignments

- F1 – Truck ID
- F3 – UNITS key
- F4 – Reprint / Reports
- F5 – SELECT key
- Alt-B – Green Light (START)
- Alt-Q – Red Lite (STOP)



Note: A full USB keyboard allows Alphanumeric characters to be used in the Truck IDs

4.3.6 Truck In Out Setpoints

For the Truck I/O application, I/O4 controls the green light and I/O5 controls the red light and any edits to these setpoints will be overwritten by the application. I/O 6 can be configured to control a peripheral device like a printer or an alarm.

4.3.7 Printing

If a Truck Inbound/Outbound or Fleet transaction is in process, when **PRINT** is pressed the associated ticket print format will be transmitted through the configured port.

If a Truck transaction is not in process, then when you press the **PRINT** key, the configured print format will be output through the configured port to the connected peripheral device. The indicator can be configured to only allow one print for each weighing sequence. If **PRINT** is pressed when so configured, **cAnt** is displayed instead of printing again.



*Note: Technicians can quick select a Print Format by using the keypad. For example, key in 1 9 and press the **PRINT** key to print a ticket using Print Format 19, 3 5 to get Print Format 35, etc.*

Printing any of the configured print formats is possible using the Numbered Print feature. Enter the print format number and then press the **PRINT** key. The selected print format will be transmitted out all ports that are configured to print. This feature is disabled during a Truck In/Out transaction sequence.

To clear an Inbound or Outbound transaction before printing:

1. Press **F1** and key in the correct truck ID. This will override the current ID shown in the scale.
2. When the Inbound or Outbound annunciator is lit, press the **C** key to clear it.
Clr TrK will flash before returning to normal gross weight mode

Printing Reports

The ZM223 can recall and print data of the following

- All Inbound Truck still onsite
 - All Outbound Truck Transactions
 - All Fleet Transactions
1. To print any of these reports, press and hold the **PRINT** key until **REPRINT** is displayed.
 2. Use ◀ or ▶ to toggle between the options (**Reprint**, **Out Reprint**, or **Fleet Reprint**)
 3. Press ↵ to make a selection.
 4. To clear these reports, see [page 143](#) for details.

Inbound Reprint

```
Inbound Vehicle Report
00:45:16 08-01-2025

ID   Time      Date      Weight
-----
124 12:31:55 08-01-2025 1980 lb
125 12:39:05 08-01-2025 2500 lb
126 12:39:37 08-01-2025 2680 lb
127 12:39:58 08-01-2025 3100 lb

End of Inbound Report
```

Outbound Reprint

```
Outbound Vehicle Report
00:47:37 08-01-2025

ID   # Trans  Total Net Wt
-----
124         2    20020 lb
125         1     7120 lb
127         1     6520 lb

End of Outbound Report
```

Fleet Reprint

```
Fleet Vehicle Report
00:54:33 08-01-2025

Fleet ID  Tare Wt  # Trans  Total Net Wt
-----
1002     1500 lb     1    2160 lb
1003     1000 lb     0     00 lb

End of Fleet Report
```



Note: All instructions concerning an application's Setpoints are covered in the Supervisor Menu Section on [page 128](#).

4.4 Counting Application

This section covers the ZM223's Counting application. The application has both Basic Counting and Checkcounting functions.

Basic Counting allows users to sample a set number of the same parts to quickly establish an accurate piece weight that can then be used to count a larger quantity of parts.

Checkcounting is a combination of counting and checkweighing. Where checkweighing works off a weight tolerance, checkcounting works on parts being counted. This feature is perfect for applications where parts are boxed, bagged, or sold by a set quantity

In checkcounting the accept window is based off the number of parts that are on the scale. The under and over limits are set in the supervisor menu and stored under the PLU number and control the number of counted parts that need to be counted for the accept window lights up. If the target box quantity is 100 parts and the under limit and over limit are set the same as 100. This means only the exact quantity of 100 parts will show in the accept window, 99 will show as under and 101 will show as over.

The ZM223 multi-color backlight clearly identifies when a container is filled with the correct number of parts. See the default color combination for the Checkcounting app below.



UNDER Target

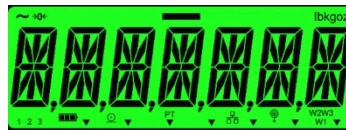

AT Target



OVER Target

The Accept Window is set using an Under/Over limits per part type.

For example, if the target box quantity is 100 parts and the lower limit is set to 99 and the high limit is set to 101 parts. When the count is under 99 parts the backlight will be orange, when the number of parts in the container is between 99 and 101 parts the indicator's Display will turn from orange to green (ACCEPT), and if the count goes over 101 parts the backlight will be red.



Note: The current Under, Over, and Accept backlight colors can be changed under the Supervisor menu under Backlight

The generic weighing functions are found in Section 3 and used in most of the ZM223 applications. Only counting features are highlighted in Section 4.4 of this manual.

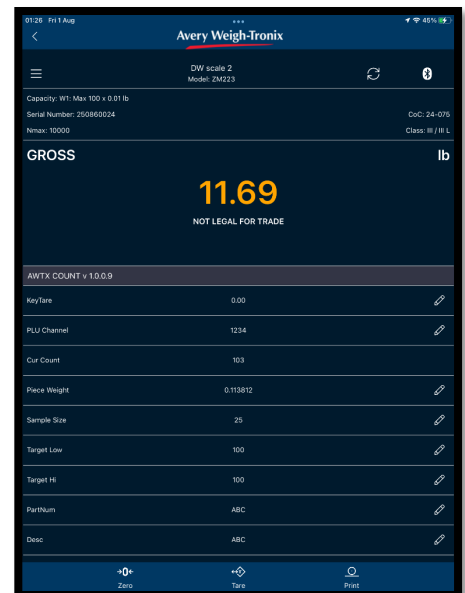

Remote Assist Counting Home Page

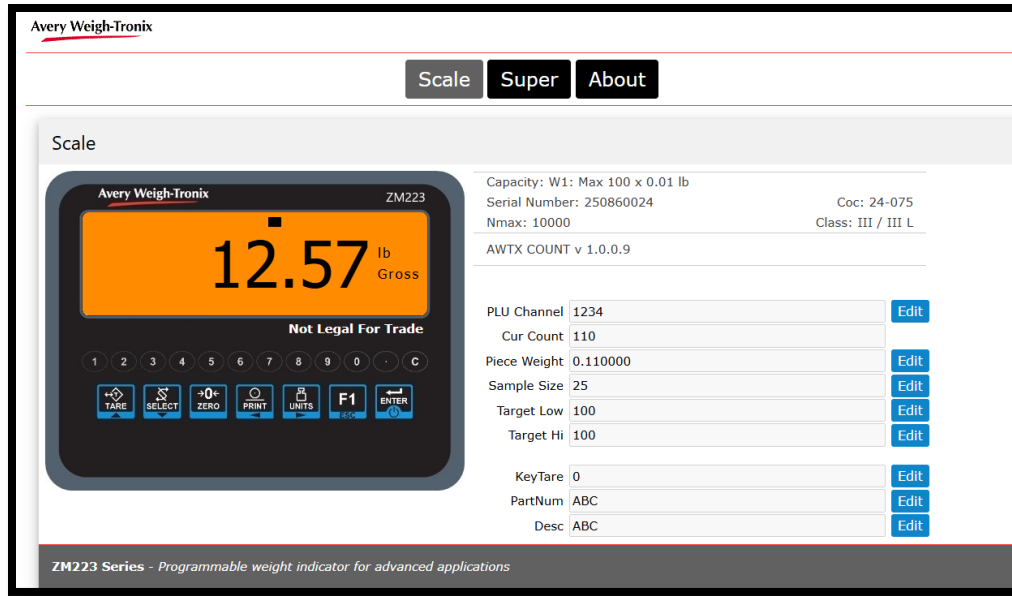

Web Browser Counting Home Page

4.4.1 Basic Counting Principles

Accuracy with this system can be extremely high, even with small parts, if the environment is controlled, parts have a consistent weight, and a large enough sample size is used. There are several things which affect counting accuracy

- Environmental noise (vibration, wind, etc.)
- Number of sample parts used
- The weight consistency of the sample parts
- The weight of one part.
- Accuracy requirement.
- The scale itself (BSQ Digital will supply a more accurate sample compared to an analog scale base)













Changes in anyone of these variables can affect the accuracy of the counting application. If there is wind or vibration, accuracy will drop, especially if parts are small in weight. If parts are not a consistent weight, accuracy can be poorer but may be increased by using a large sample size.



4.4.2 Using Counting Function

The ZM223 Counting Application can be used in the following ways:

- Sample a number of parts to establish a new piece weight, use this new piece weight to count a larger quantity of parts accurately.
- Sample parts using the Bulk or Dribble methods.
- Enter a known piece weight using the Piece Weight RPN function.
- Recall a known piece weight from the ZM223 PLU memory.

4.4.3 Indicator Key Functions

Key	Push Duration	Function
	Press	Tares off box/container weight.
	Press and Hold	Clears Tare value
	Press	Toggles between Gross, Tare, Net, Piece Weight, and Counts.
	Press and Hold	Select or view the active PLU number
	Press after entering RPN scale number	Default RPN activation key (can be changed in the Supervisor Menu) If a second scale base is connected this allows you to change from base 1 to base 2
	Press	Zeros Scale
	Press	Sends a stable weight transaction to a Printer or PC
	Press and Hold	Print and clear Totals when Print Total is activated in the Supervisor Menu
	Press	Toggles between active units of Measure lb-kg- g -oz
	Press after entering a new Piece Weight Value	Enter a new Piece Weight
	Press	Sampling
	Press after entering a new sample size number	Save a new sample

	Press	Accepts entered values – turns on scale when off
	Press once the desired number of parts are on the scale to finish sampling	Changes the sample size quantity

The following function can be set up as an RPN secondary key function:

- Base Switching (default **SELECT**)
- PLU Selection
- Piece Weight (default **UNITS**)
- Print Format (default **PRINT**)
- Sample Size (default **F1**)
- ID
- Output 4 to 6
- Low Limit
- High Limit

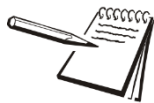

Note: Turning any of these secondary key functions can be done under the supervisor menu under RPN (page [Error! Bookmark not defined.](#)).

4.4.4 Special Key Functions



Sampling:

The **F1** key starts the sampling process to establish a new Piece Weight.

1. Press **F1** key the scale automatically Zeros and display's the Sample quantity to load on the scale.
2. Load the required sample quantity of the same parts on the scale and press  ...

The new Piece Weight will now be used to accurately count a larger quantity of the same part

If an active PLU from 1 to 2000 is active once the sampling process has finished, it will ask to Save the new Piece Weight over the current PLU number.

3. To not save over the current PLU, with **No** displayed press  ...
The new piece weight will remain active but the PLU with automatically change to PLU 0 and remain unsaved.
4. To save over the current PLU use  to toggle to **YES** and press  ...
The new Piece Weight is now saved over the old Piece Weight for the selected PLU.





Note: The PLU Updated message will only be seen if the PLU Database is enabled in the Supervisor Menu.

Pressing the **SELECT** key allows users to cycle through and view the Gross, Net, Tare, Count, Piece Weight, Count Total, Gross Total, Net Total, and Transaction Count can only be seen when the scale is within the gross zero band and Print Totals are turned on in the supervisor menu

- When the Count Total is displayed, both the Count and TOTAL annunciators will be lit.
- When the Gross Total is displayed, both the GROSS and TOTAL annunciators will be lit.
- When the Net Total is displayed, both the Net and Total annunciators will be lit.

If a stored PLU is active, hold down the **SELECT** key until PLU is flashed on the display then the active PLU is shown. To change this PLU key in a new PLU, key in the new number and press . The active piece weight and check tolerances for that PLU will now be loaded.

Saving sample data to a new PLU number:

1. Press and hold the **SELECT** key...
The active PLU is now displayed
2. Key in the PLU you wish to overwrite, and press  ...
3. Perform the Sampling process explained below and when prompted to update the PLU use  to toggle to **YES** and press  ...



Note: This PLU function will only be available if the PLU database has been enabled in the Supervisor Menu (see [page 21](#)).

Base Switching:

If activated, use the indicator's numeric keys to enter in the base number (1, 2,) and then press the RPN activation key (**SELECT** by default).

Automatic Base Switching

Within this app there is also an automatic base switching feature that if turned on in the supervisor menu allows the sample process to be carried out on the smaller base capacity and then automatically switches to the larger base to carrying out the main counting. This allows you to get a more accurate piece weight by using the smaller scale.

Subject to how this is set up in the supervisor menu you can sample on base 1 and count on base 2 or it can be set the other way around.

4.4.5 Sample Operation

The ZM223 can use two different sampling methods: Bulk and Dribble. Sampling methods can be selected under the Supervisor Menu.

1. To view the sample size and begin the sample process, press the **F1** key. The default sample size is 25.
2. To change this sample size, first abort sampling, key in the new sample size and press the RPN key (**F1/Sample Size**).

Sampling with a New Sample Size

1. Press **F1**, zeroing, add number
2. Add the number of components to the scale and press  ...

If successful, the display will now show count quantity on the scale.



If unsuccessful, the scale will ask for a larger quantity to be added to the scale.

Note: If the larger quantity still fails this may mean the environmental conditions the scale is in are not suitable to achieve the required accuracy. Move the scale to an area away from drafts or vibrations.

Dribble Sampling (Default):

With the counting application and the bulk sampling method active, follow these steps to count.

1. Press **ZERO** to zero the scale.
2. Press **F1/SAMPLE** ...
Zeroing is briefly displayed. This means the indicator is zeroing itself. The current sample size is displayed as a numeric value (XX).
3. Place the correct number of samples on the scale all at the same time...
busy is briefly displayed, followed by one of two possible outcomes:
 - a. If the sample met the minimum sample requirements and the weight is stable, the display will show the correct number of parts on the scale and the **COUNT** annunciator will be lit.
 - b. If the sample size did not meet the minimum sample requirements or if the weight was unstable, **Abort** is briefly displayed, and the display returns to gross weighing mode. Repeat steps 3 through 5 using a larger sample size.

Bulk Sampling:

With the counting application and the bulk sampling method active, follow these steps to count.

4. Press **ZERO** to zero the scale.
5. Press **F1/SAMPLE** ...
Zeroing is briefly displayed. This means the indicator is zeroing itself. The current sample size is displayed as a numeric value (XX).
6. Place the correct number of samples on the scale all at the same time...
busy is briefly displayed, followed by one of two possible outcomes:
 - a. If the sample met the minimum sample requirements and the weight is stable, the display will show the correct number of parts on the scale and the **COUNT** annunciator will be lit.
 - b. If the sample size did not meet the minimum sample requirements or if the weight was unstable, **Abort** is briefly displayed, and the display returns to gross weighing mode. Repeat steps 2 and 3 using a larger sample size.



Note: Minimum sample weight is the gross zero band value. The initial sample count is 5 pieces. The maximum number of pieces that can be sample is 100,000.

4.4.6 Reviewing Piece Weights

A Piece Weight can be reviewed by using the **SELECT** key until the **Piece WT** annunciator is illuminated. Operators can view the Piece Weight directly from the ZM223 Remote Assist mobile app or Web browser page.

4.4.7 Using Checkcounting Feature

Checkcounting allows users to set an upper and lower count limit that triggers the ZM223 Indicator to signal when the target quantity has been reached. Checkcounting can be turned on in the Supervisor Menu.

1. Press the **ZERO** key to zero the scale
2. With a Piece Weight already set and the indicator working in Count mode, place the empty box or container on the scale and press **TARE**.
NET COUNT Zero should now display
3. Place the parts to be counted in the box or container on the scale
4. If the count is **UNDER** the Target Quantity the Under-Annunciator Bars is illuminated and the backlight will be showing Red ...
Place more parts on the scale until the center Accept Bar is illuminated and the display backlight goes Green.
5. If the count quantity is **OVER** the target count quantity the Over Bars is illuminated, and the backlight color changes to Orange.

4.4.8 Setting Target Quantity

Target Quantities can be entered and controlled in the ZM223 1 of 5 ways



1. PLU Database control
2. Set the general high and low limits from inside the Supervisor menu
3. Entered in high and low limits using RPN function
4. Enter in high and Low limits from the Mobile app
5. Enter in high and Low limits from the web browser app

PLU Database: The ZM223 has an internal database that can hold up to 2000 known PLUs with Piece Weights and Checkcount Limit parameters.

The PLU database must be activated in the Supervisor Menu. When active, it allows the operator to load any of the 1 to 2000 stored PLUs in the ZM223 internal memory.

Once set in the PLU Database a PLU number can recall information like the **Piece Weight Value**, **Hi Tol**, and **Lo Tol** and the indicator will automatically work based off that saved information.

View and Change the Active PLU:

1. With the PLU database activated, press and hold the **SELECT** key for 3 seconds...
The screen will flash **PLU** then the active PLU number is displayed.
2. Press  to return to counting using the displayed PLU piece weight.
3. To change a PLU, with the active PLU number displayed, key in the desired PLU number and press the  ..
The display will flash the new PLU number before returning to counting mode using the new piece weight values.

General High and Low Target setting: This can only be set if Check is enabled in the Supervisor Menu. A general high limit and a low limit can be set to control all under Over and Accept bars along with backlights.

Entered Target Value using RPN:

Low Targ and **HI Targ** RPN keys are set in the Supervisor Menu.

Label the defined RPN keys with the Under and Over Label stickers that come with the ZM223 indicator

1. Use the numeric keys to enter in the high quantity in parts followed by the **High Target** RPN key...
The display will flash **HI TARG** and then display the entered target number in parts before going back to the count Screen
2. Use the numeric keys to enter in the Low limit quantity in parts followed by the **Under** RPN key...



Note: To only allow the target quantity to be in the Accept Window. Set both the under and over to the same quantity (ex: 100). This will ensure that only 100 is inside the accept window.

Entered Target Value Using Mobile App or Web Browser Pages:

1. With the Remote Assist app installed, pair the mobile device to the indicator...
The app profile will now load onto into the phone app.
2. With Hi Target and Low Target enabled in the mobile app, press the **Low Targ** and **HI Targ** text area in the mobile app.
3. Now enter in the new High and Low Quantities and press **SAVE...**
This saved the new High and Low Quantity in now updated back within the indicator.
4. This indicator will flash **HI TARG** and then the new target Quantity **1000** before reverting to the count screen.



Note: If Lo Targ and HI Targ field entry is not seen on the mobile app, this field needs to be activated in the indicator under the Supervisor Menu Mobile field.



Note: All instructions concerning an application's Setpoints are covered in the Supervisor Menu Section on [page 128](#).

4.5 Checkweighing Simple-Level Application

This section applies if the ZM223 Simple Checkweighing Application. The Simple Checkweighing application is a fast and efficient checkweighing application that displays the \pm deviation from a set target point.

The Checkweighing Simple app works based on the Target Value being 0.

Once the known target weight is placed on the scale, press the **F1** key to establish the target point as 0. The under and over values work off this Target Zero Point.

4.5.1 Checkweighing Display Visuals

Along with the display's backlight changing color depending on how the current weight relates to the target parameters, the ZM223's display also features a fine-tuning bar graph at the top of the display that also serves to assist operators in checkweighing.

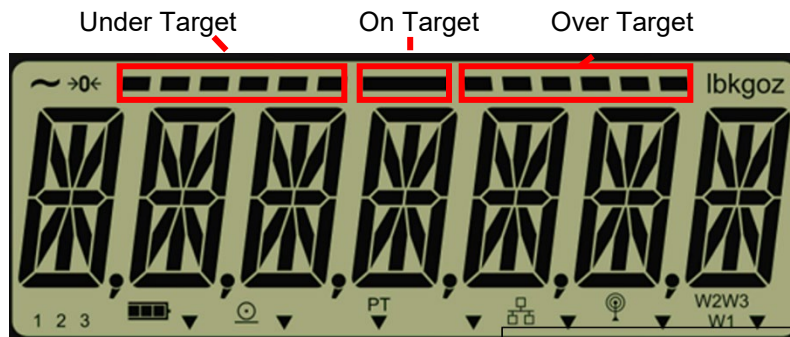

The fine-tuning bar graph can be used to quickly adjust the packed weight to be within the required Accept quantity.

Both Under and Over bars consist of 6 segments and can be used to help the operator quickly see how close the weight is to the Accept Window. The default for each segment of both Over and Under bars equals one division.

External Check Lights: The ZM223 can also be connected to external lights or alarms that can be set to outputs linked to the UNDER, OVER, ACCEPT conditions. To link in and setup the ZM223 external outputs please contact an approved service provider.

Setting an Accept Window: Setting Accept Windows in the ZM223's Checkweighing Simple app can be done in 4 ways

Red – Under the Accept Window

Green – At the Accept Window

Orange – Over the Accept Window

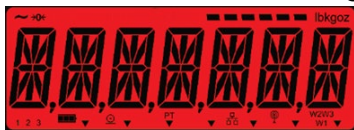

UNDER Target



AT Target



OVER Target









*Note: All backlight colors can be changed from within the Supervisor Menu under the **Check** and the **BckMode** fields.*



*Note: To cancel an RPN entry and return to normal operation, press the **C** key.*

Note: Every ZM223 comes with a key label pack for users to place over a key or annunciator so it is correctly labeled.

4.5.2 Indicator Key Functions

Key	Push Duration	Function
	Press	Toggles between Gross weight and Target weight deviation
	Press	Zeros Scale
	Press	Sends a stable weight transaction to a Printer or PC
	Press	Toggles between active units of Measure lb- kg- g -oz
	Press	Quick check Target
	Press with no weight on the scale	View the accept window parameters and edit the low tolerance and high tolerance from the target point.
	Press	Accepts entered values – turns on scale when off



Note: Pushbutton or Preset Tare functions are not available in this application

The following function can be set up as an RPN secondarily key function:

- Print Format (Default **PRINT**)
- Tol Lo
- Tol Hi
- ID (Default **UNITS**)

4.5.3 Special Key Functions

The following keys have an extra function in this application: Within this Checkweighing app the **F1** key functions as a Quick Check **TARGET** key. Dedicated key labels can be attached to the overlay to help the operator know what the **F1** key is now controlling.

F1/TARGET: With a known sample weight on the scale, press **F1/TARGET** key to perform a target point for the accept band to work off.

The display zeros (0.000), the Accept Segment of the bar graph lights up, and the backlight turns green. In this mode the required target weight is always 0 and the Under and Over Accept Bands work from this zero-target point.

Underweight: The backlight will turn red and illuminate the Under-bar graph annunciator to visually show how far away the current weight is from the Accept Window.

Overweight: The backlight will turn orange and illuminate the Over bar graph annunciator to visually show how far away the current weight is from the Accept Window.

Press the **F1/TARGET** key when the scale is at Zero to view and edit the Low and High tolerances.

4.5.4 Checkweighing Operation

Switching Between Checkweighing and Normal Weighing Mode

1. To switch between any Checkweighing app and General Weighing mode, press **SELECT...**

When the GROSS annunciator is displayed, the unit is in normal weighing mode

OR

When the GROSS annunciator disappears, the unit is now in Checkweigh mode. The display may show a negative weight and the Under Segments of the bar graph annunciator may be lit if there is an active target value.

Setting a New Target Weight

2. If necessary, press **ZERO** to zero the scale...
3. Place an item of the desired Target Weight on the scale and press **F1/TARGET...**
The indicator will flash **TARGET** and then display the live weight as **0** with the center Accept segment illuminated showing that the target weight has been set successfully.



*Note: If motion is present for greater than 2-3 seconds after the **F1/TARGET** key press, the target operation will be aborted and the word cant will be displayed briefly.*





4. Clear the scale and place the next item on the scale ...
The bar graph and backlight will now show if the new item is over, under, or at the set Target Weight.



Note: By default, the Accept Segment lights if the weight is within the high and low tolerance weight.

View and Set Low and High Tolerances

Follow the steps below to view or edit the Low and High Tolerances.

1. With no weight on the scale, press the **F1** key...
Lo-Tol is now displayed.
2. Press  ...
The current Low Tolerance value is now displayed.
3. To change Low Tolerance value, key in the new Low Tolerance and press  to accept...
Lo-Tol is now displayed.
4. Press  ...
Hi-Tol is now displayed
5. Press  ...
The current High Tolerance value is now displayed.
6. To change the High Tolerance, key in the new High Tolerance and press  to accept...
Hi-Tol is now displayed.
7. Press **F1** to return to the normal weighing mode.



*Note: Viewing either low or high tolerances will time out after 5 seconds or when the operator presses the **F1/TARGET** key again to return the Checkweighing screen.*

Note: The tolerances can be set from 1 division to the capacity of the scale.

4.5.5 RPN Functions and Checkweighing

An RPN function is a way to use a single key for two different functions. Each Function key can be reassigned to perform a different function subject to the app that is running. Some of these functions work within app by default.

Using RPN keys:

Key in the value using the numeric keys and then press the RPN key that has been selected for that function.

For Example: entering in a Tol low weight of 0.002 lb

Key in 0.002 lb and press the RPN activation key...

Tol low then **0.002** will display before reverting to Checkweigh mode.

The Under/Over accept bar graph along with the backlight color will now turn on work with the new Accept Weight Tolerance bands.



Note: All instructions concerning an application's Setpoints are covered in the Supervisor Menu Section on [page 128](#).

4.5.6 Printing and Checkweighing

With a printer connected and configured, press the **PRINT** key to print out the difference from the Target Zero Point.

For example:

ACCEPT:	0.00 lb
UNDER:	-0.61 lb
OVER:	0.30 lb

4.6 Checkweighing Mid-Level Application

This section applies if the ZM223 Mid-Level Checkweighing Application is installed. The Mid-Level Checkweighing application works by using Tolerances and a Target Value or by Upper and Lower Weight Limits. The Checkweighing Mid application also allows the user to print the Target Weights and capture other weight data in the background.

This app allows:

- Quick Check key – to help speed up setup
- Positive and negative checkweighing programs
- Target Weight with tolerances or High and Low weight band limits
- Back-office weight data capture stats programs
 - Standard deviation
 - X-Bar/R Stats programs

4.6.1 Checkweighing Display Visuals

Along with the display's backlight changing color depending on how the current weight relates to the target parameters, the ZM223's display also features a fine-tuning bar graph at the top of the display that also serves to assist operators in checkweighing.

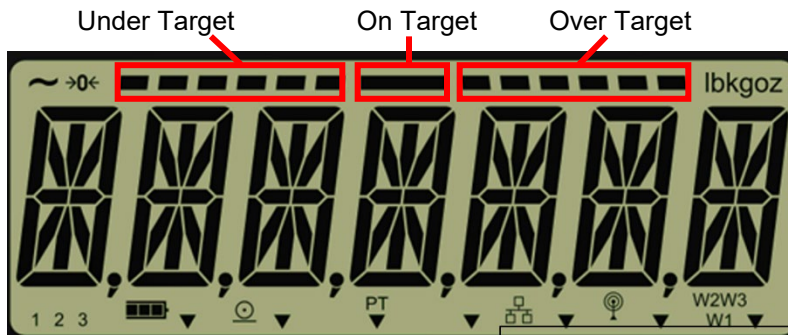

The fine-tuning bar graph can be used to quickly adjust the packed weight to be within the required Accept quantity.

Both Under and Over bars consist of 6 segments and can be used to help the operator quickly see how close the weight is to the Accept Window. The default for each segment of both Over and Under bars equals one division.

External Check Lights: The ZM223 can also be connected to external lights or alarms that can be set to outputs linked to the UNDER, OVER, ACCEPT conditions. To link in and setup the ZM223 external outputs please contact an approved service provider.

Setting an Accept Window: Setting Accept Windows in the ZM223's Checkweighing mid app can be done in 4 ways

Red – Under the Accept Window

Green – At the Accept Window

Orange – Over the Accept Window



UNDER Target



AT Target





OVER Target



Note: All backlight colors can be changed from within the Supervisor Menu under the Check and the *bckModE* fields.

4.6.2 Indicator Key Functions

Key	Push Duration	Function
	Press	Tares off box/container weight.
	Press and Hold	Clears Tare value
	Press	Toggles between Gross, Tare, and Net.
	Press	Zeros Scale
	Press	Sends a stable weight transaction to a Printer or PC
	Key in a Print Format Number and then press	Changes the active Print Format
	Press and Hold	Prints Stats Totals
	Press	Toggles between active units of Measure lb- kg- g -oz
	Press	Quick check Target
	Press when the scale is at zero	View and edit the High, Low, and Target values
	Press	Accepts entered values



RPN functions allowed in this app

- ID (default **UNITS** key)
- Print Format (default **PRINT** key)
- Tol Low
- Tol High
- Target
- Under Segment Division
- Over Segment Division

4.6.3 Special Key Functions

The following keys have an extra function in this application: Within this Checkweighing app the **F1** key functions as a Quick Check **TARGET** key. Dedicated key labels can be attached to the overlay to help the operator know what the **F1** key is now controlling.

Pressing the **SELECT** key allows users to cycle through and view the Gross, Net, Tare, Gross Total, Net Total, and Transaction Totals



- When the Gross Total is displayed, both the GROSS and TOTAL annunciators will be lit.
- When the Net Total is displayed, both the Net and Total annunciators will be lit.
- When the Transaction Count is displayed, the custom annunciator will be lit. Add the provided Transaction Count sticker to the display

F1/TARGET: With a known sample weight on the scale, press **F1/TARGET** key to perform a target point for the accept band to work off.

Once the Target is established, the scale display will turn green, and the Accept Segment of the Bar Graph will light up. The Upper and Lower Tolerances work off of the newly set Target Weight.

Press the **F1/TARGET** key when the scale is at zero, the scale displays **Lo-Tol** which is a menu prompt. You can navigate through these options to see and change the values for the lower tolerance, target weight, and high tolerance.

Changing Low Tolerance:



1. With no weight on the scale, press the **F1/TARGET** key...
Lo-Tol is now displayed
2. Press  ...
The current Low Tolerance is now displayed.
3. To change this value, key in a new value with the numeric keypad.
4. Once you have the new value set, press  to accept...
Lo-Tol is now displayed

Changing TARGET:



5. From **Lo-Tol**, press the  ...
TARGET is now displayed
6. Press  to view the current Target.
7. To change this value, key in a new value with the numeric keypad.

- Once you have the new value set, press  to accept...
TARGET is now displayed.

Changing High Tolerance:

- From **TARGET**, press the  ...
Hi-Tol is now displayed
- Press  ...
The current High Tolerance is now displayed.
- To change this value, key in the new value with the numeric keypad.
- Once you have the new value set, press  to accept...
Hi-Tol is now displayed

Exit:

- From Hi-Tol press  ...
EXIT is now displayed
- Press  to exit the Target Menu and return to normal Checkweighing mode.



*Note: Viewing either low or high tolerances will time out after 5 seconds or when the operator presses the **F1/TARGET** key again to return the Checkweighing screen.*

4.6.4 Checkweighing Operation

Setting a New Target Weight and Simple Checkweighing

- If necessary, press **ZERO** to zero the scale...
- Place an item of the desired Target Weight on the scale and press **F1/TARGET**...
The indicator will flash **TARGET** and then display the live weight with the center Accept segment illuminated showing that the target weight has been set successfully.



*Note: If motion is present for greater than 2-3 seconds after the **F1/TARGET** key press, the target operation will be aborted and the word **can't** will be displayed briefly.*

- Clear the scale and place the next item on the scale ...
The bar graph and backlight will now show if the new item is over, under, or at the set Target Weight.



Note: By default, the Target segment lights if the weight is within \pm the high and low tolerance of the target weight. The over and under segments each represent 1 division. These can be adjusted in the Supervisor Menu to represent 1 part

- Repeat step 3 for all other items to be checkweighed.

4.6.5 RPN Functions and Checkweighing

An RPN function is a way to use a single key for two different functions. Each Function key can be reassigned to perform a different function subject to the app that is running. Some of these functions work within app by default.

Using RPN keys:

Key in the value using the numeric keys and then press the **RPN** key that has been selected for that function.

For Example: entering in a Tol low weight of 0.002 lb

Key in 0.002 lb and press the RPN activation key...

Tol low then **0.002** will display before reverting to Checkweigh mode. The Under/Over accept bar graph along with the backlight color will now turn on work with the new Accept Weight Tolerance bands.

4.6.6 Negative Checkweighing

Negative Checkweighing is available in the Mid-Level and Advanced Checkweighing applications. Negative Checkweighing works by taking the total weight of a container of items on the scale and subtracting the weight of a removed item to checkweigh the removed item (Under Weight, Accept, or Over Weight). This feature can reduce steps when used correctly in processes like dispensing out of a larger bulk container.

Follow these steps:

1. Place a full container on the scale and press **TARE**...
The scale should read **0**.
2. Remove the desired amount of material from the container and press **F1/TARGET**.
3. Press **TARE** again and start the negative checkweighing process
4. Now whenever an item or items are removed from the container the ZM223 will now compare the missing weight to the checkweighing setting to checkweigh the removed items.
5. Press **TARE** again to checkweigh the next removed item from the container.

OR

If Auto Tare is active in the Supervisor Menu, simply continue to remove items from the container to continue the Negative Checkweighing process.

4.6.7 Standard Data Capture

Whenever the **PRINT** key is pressed the scale will print the weight along with checkweigh status **Under**, **Over**, or **Within** the Accept Weight Band.

OVER: 12.36 lb

OVER: 12.64 lb

UNDER: 9.72 lb

ACCEPT: 12.29 lb

When Auto print is enabled, the scale will automatically print once the weight is stable. This ticket can be customized to meet your full data capture requirements.

Standard Deviation: This statistical package controls and monitors each weight transaction and tracks all the weights each time the **PRINT** key is pressed. This allows users to see what the set Target Weights and the High and Low tolerances along with the Mean, Max, and Min recorded values. It also provides the samples taken and how many weighments fell within and outside of the Accept Window Weight. The program also captures standard deviation weight data in the background. A packrun quantity can be set to automatically print the Standard Deviation once the quantity has been reached.

Report Example

Tol Hi	=	0.05 lb
Tol Lo	=	0.05 lb
Target	=	3.00 lb

1. To print the Standard Deviation Report, press and hold the **PRINT** key for 3 seconds.

If standard deviation is turned on, operators can get individual weights by pressing the **PRINT** key and the full statistical report when the **PRINT** key is held for 3 seconds. The samples are cleared from memory when printed. If autoprint is enabled or the **PRINT** key is pressed a valid transaction occurs.

Printing the Report:

Press and hold the **PRINT** key for 4 seconds, display will flash "Std-dEv Prn-tot" and the report will be printed, then the samples will be cleared from memory.

# Over	=	0
# Under	=	0
#Accept	=	16
Mean	=	2.84 lb
Max Wt	=	3.04 lb
Min Wt	=	0.00 lb
Std Dev	=	0.67
C of V	=	0.24 PCT
# Smpl	=	20



Note: To get the above report the Total Print Format must be set to 41.

4.6.8 X-Bar/R Program

The X-Bar/R program is designed to weigh process samples, establish the average weight, calculate the range between high and low weights, and the trend of deviation. If the X-Bar/R feature is enabled, the ZM223 will keep a queue of the average weights of the last eight sample sets. This queue of averages is used to print trend information on the statistical reports.



Note: The Report Printout for the X-Bar/R program can be customized to present statistical data of your choosing. This information is found in the Service manual.

1. With X-Bar/R running follow the below steps.
2. With the scale at zero, place the item on the scale.
3. When the weight is stable, press **PRINT**...
If a printer or similar device is connected, a ticket is printed for this transaction and the transaction is stored.
4. Remove the item from the scale.
5. Repeat these steps until all items have been weighed.
6. When the number of transactions reaches the specified number press and hold the **PRINT** key to print the X-Bar/R averages based on that subset, the indicator flashes **PRN-TOT** and sends the trend information to a connected device.

Trend Message	Meaning
1 of 1	The last average in the queue has an error greater than 3x the limit
2 of 3	Two of the last three averages in the queue have an error greater than the limit.
4 of 5	Four of the last five averages have an error greater than the limit.
8 of 8	Eight of eight averages are on the same side of the target weight.

Tol Hi =	3.100 lb
Tol Lo =	2.900 lb
Target =	3.000 lb
Ave Wt =	3.526 lb
Range =	1.200 lb

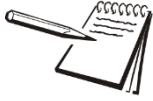

*Note: X-Bar/R are configured in a password-protected menu.
The print format for the total format (with trend information) can be customized in a password-protected menu.
If you want to print the trend information/totals, press and hold the **PRINT** key.*



Note: All instructions concerning an application's Setpoints are covered in the Supervisor Menu Section on [page 128](#).

4.7 Checkweighing Advanced-Level Application

This section applies to the ZM223 Advanced Checkweighing Application. This application is identical in function to the Mid-Level application but with several additional features.

Like the Checkweighing Mid Application the Advanced Application has:

- Quick Check Key – to help speed up setup.
- Positive and negative checkweighing programs.
- Target Weight with tolerances or High and Low weight band limits.
- Back-office weight data capture stats programs
 - Standard deviation
 - X-Bar/R Stats programs

The additional Checkweighing Advanced features are:

- 1 to 500 Product Look Ups Data base (PLUs) for holding known Under, Over, and Accept tolerances.
- Packrun data to track data based on known quantity of weighments needed to complete packrun.
 - This also enhances Standard Deviation and X-Bar to allow data to be automatically printed based on the packrun size.

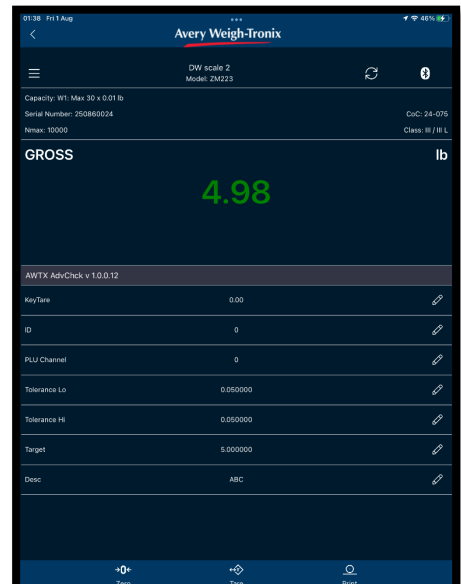

Remote Assist Check Adv Home Page

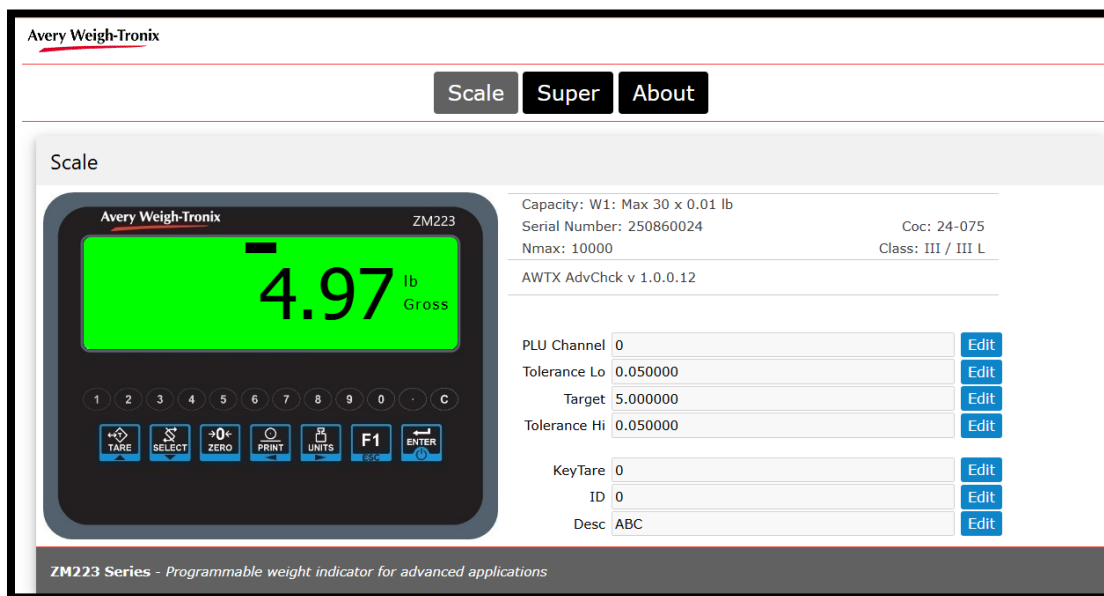

Web Browser Check Adv Home Page

4.7.1 Checkweighing Display Visuals

Along with the display's backlight changing color depending on how the current weight relates to the target parameters, the ZM223's display also features a fine-tuning bar graph at the top of the display that also serves to assist operators in checkweighing.

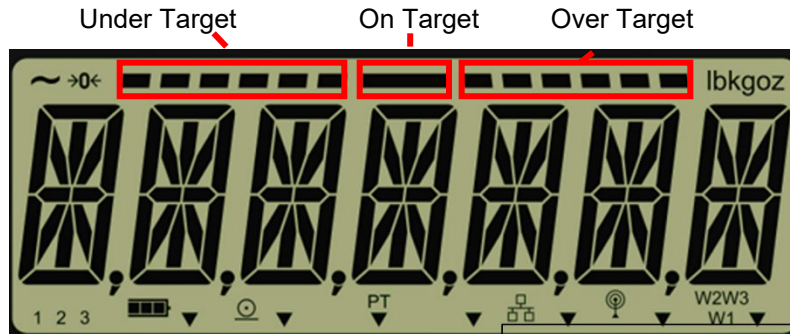

The fine-tuning bar graph can be used to quickly adjust the packed weight to be within the required Accept quantity.

Both Under and Over bars consist of 6 segments and can be used to help the operator quickly see how close the weight is to the Accept Window. The default for each segment of both the Over and Under bars equals one division.

External Check Lights: The ZM223 can also be connected to external lights or alarms that can be set to outputs linked to the UNDER, OVER, and ACCEPT conditions. To link in and setup the ZM223 external outputs please contact an approved service provider.

Setting an Accept Window: Setting Accept Windows for all the ZM223's Checkweighing apps can only be set by either manually entering in the target weight along with the upper and lower tolerance setting using the RPN key function, using the ZM223 Remote Assist mobile app, or the web browser page.

This target quantity can also be recalled by using a preprogrammed PLU number from 1 to 500.

Red – Under the Accept Window

Green – At the Accept Window

Orange – Over the Accept Window

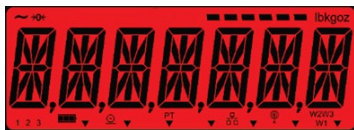

UNDER Target

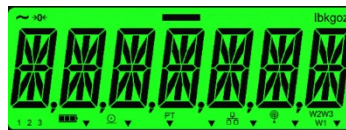

AT Target



OVER Target









*Note: All backlight colors can be changed from within the Supervisor Menu under the **Check** and the **bcKModE** fields.*



Note: Every ZM223 comes with a key label pack to place over a key or annunciator so it is correctly labeled.

4.7.2 Indicator Key Functions

Key	Push Duration	Function
	Press	Tares off box/container weight.
	Press and Hold	Clears Tare value
	Press	Toggles between Gross, Tare, and Net.
	Press and Hold	To enter PLU database and view and change active PLU
	Press	Zeros Scale
	Press	Sends a stable weight transaction to a Printer or PC
	Press and Hold	To Print Totals or Stat Totals
	Key in a Print Format Number and then press	Changes the active Print Format
	Press	Toggles between active units of Measure lb, kg, g, and oz
	Press	Quick Check Target
	Press when the scale is inside the Gross Zero Band	To view the High and Low Tolerances and the Target Weight value

	Press	Accepts entered values
---	-------	------------------------

The following function can be set up as an RPN secondary key function:

- Print Formats (default **PRINT**)
- Target
- Low Tol
- Hi Tol
- ID (Default **UNITS**)
- PLU

4.7.3 Special Key Functions

The following keys have an extra function in this application: Within this Checkweighing app the **F1** key functions as a Quick Check Target for PLU 0. The Quick Check function will not work on PLUs 1 to 500. Dedicated key labels can be attached to the overlay to help the operator know what the **F1** key functions is now controlling. Pressing the **SELECT** key allows users to cycle through and view the Gross, Net, Tare, Gross Total, Net Total, and Transaction Totals only when the scale is within the gross zero band.

- When the Gross Total is displayed, both the GROSS and TOTAL annunciators will be lit.
- When the Net Total is displayed, both the Net and Total annunciators will be lit.
- When the Transaction Count is displayed, the custom annunciator will be lit. Add the provided Transaction Count sticker to the display.

View and edit the active PLU

1. Press and hold the **SELECT** key...

The display will flash **PLU** and then the active PLU number is now displayed.

2. To change the PLU, key in the new PLU number and press  ...

The new PLU number is now active.



Note: PLU 0 is a PLU slot that cannot be overwritten or saved over.



*Note: PLU 1 to 500 are Stored PLUs that are stored inside the Supervisor Menu, pressing the **F1** key with no weight on the scale only allows users to view the prestored PLU weight values for the Under, Over, and Accept values.*



F1/TARGET: With a known sample weight on the scale, press **F1/TARGET** key to perform a target point for the accept band to work off.

Press the **F1/TARGET** key when the scale is at Zero to view and edit the Target Weight.



F1/TARGET:

1. Place the sample on the scale prior to going through the injection machine.
2. Press the **F1/TARGET** to establish the weight sample...



Changing Low Tolerance:

3. With no weight on the scale, press the **F1/TARGET** key...
Lo-Tol is now displayed
4. Press  ...
The current Low Tolerance is now displayed.
5. To change this value, key in a new value with the numeric keypad.
6. Once you have the new value set, press  to accept...
Lo-Tol is now displayed



Changing TARGET:

7. From **Lo-Tol**, press the  ...
TARGET is now displayed
8. Press  to view the current Target.
9. To change this value, key in a new value with the numeric keypad.
10. Once you have the new value set, press  to accept...
TARGET is now displayed.

Changing High Tolerance:

11. From **TARGET**, press the  ...
Hi-Tol is now displayed
12. Press  ...
The current High Tolerance is now displayed.
13. To change this value, key in the new value with the numeric keypad.
14. Once you have the new value set, press  to accept...
Hi-Tol is now displayed

Exit:

15. From Hi-Tol press  ...
EXIT is now displayed
16. Press  to exit the Target Menu and return to normal Checkweighing mode.



*Note: Viewing either low or high tolerances will time out after 5 seconds or when the operator presses the **F1/TARGET** key again to return the Checkweighing screen. For PLU 1 to 500 pressing the **F1** key at zero only allows users to view the weight parameters for that PLU.*

4.7.4 Checkweighing Operation

Switching Between Checkweighing and Normal Weighing Mode

- To switch between any Checkweighing app and General Weighing mode, press **SELECT**...

When the GROSS annunciator is displayed, the unit is in normal weighing mode.

OR

When the GROSS annunciator disappears, the unit is now in Checkweighing mode. The display may show weight and the **Under**, **Over**, or **Accept** Segments of the bar graph annunciator may be lit if there is an active target value.

Setting a New Target Weight for Advanced Checkweighing

Setting a target weight can be done 4 different ways

- If necessary, press **ZERO** to zero the scale...
 - Quick Check method, place a known target weight on the scale and press **SELECT**, set **PLU 0**, and press the **SELECT** key when there is no weight on the scale.
 - Recall a prestored PLU by pressing and holding the **SELECT** key
 - The Remote Assist Mobile App
 - Use the Web Browser Pages
- Place the item on the scale to initiate the checkweighing process.



*Note: If motion is present for greater than 2-3 seconds after the F1/TARGET key press, the target operation will be aborted and the word **cant** will be displayed briefly.*

- Receive Checkweight.
- Clear the scale and place the next item on the scale ...
The bar graph and backlight will now show if the new item is over, under, or at the set Target Weight.



Note: By default the Target segment lights if the weight is within \pm the high and low tolerance of the target weight. The over and under segments each represent 1 division.

- Repeat steps 2-4 for all other items to be weighed.

4.7.5 RPN Functions and Checkweighing

An RPN function is a way to use a single key for two different functions. Each Function key can be reassigned to perform a different function subject to the app that is running. Some of these functions work within app by default.

Using RPN keys:

Key in the value using the numeric keys and then press the RPN key that has been selected for that function.

For Example: entering in a Tol low weight of 0.002 lb

Key in 0.002 lb and press the RPN activation key...

Tol low then **0.002** will display before reverting to Checkweigh mode. The Under/Over accept bar graph along with the backlight color will now turn on work with the new Accept Weight Tolerance bands.

4.7.6 Negative Checkweighing Operation

Negative Checkweighing is available in the Mid-Level and Advanced Checkweighing applications. Negative Checkweighing works by taking the total weight of a container of items on the scale and subtracting the weight of a removed item to checkweigh the removed item (Under Weight, Accept, or Over Weight). This feature can reduce steps when used correctly in processes like dispensing out of a larger bulk container. Follow these steps:

1. Place a full container on the scale and press **TARE...**
The scale should read **0**.
2. Remove the desired amount of material from the container and press **F1/TARGET**.
3. Press **TARE** again and start the negative checkweighing process
4. Now whenever an item or items are removed from the container the ZM223 will now compare the missing weight to the checkweighing setting to checkweigh the removed items.
5. Press **TARE** again to checkweigh the next removed item from the container.

OR

If Auto Tare is active in the Supervisor Menu, simply continue to remove items from the container to continue the Negative Checkweighing process.

4.7.7 Using PLUs

ZM223 Indicators come standard with an internal database that can hold up to 500 PLUs or Part Look Up. PLUs are used to quickly recall saved piece weights, along with other useful parameters. PLUs must be set up through a password-protected menu.

- Target
- Under Tolerances by Weight
- Over Tolerances by Weight

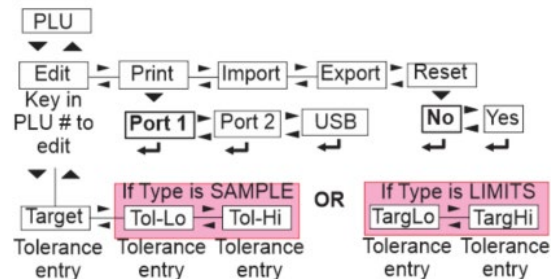

PLU 0 is a free PLU that cannot be saved over. PLU 1 to 500 hold data that can be stored and recalled even after the indicator has been turned off.

4.7.8 Choosing a PLU and Checkweighing



Note: Over, Under, and Target values for the PLU registers are entered in a password protected menu. See the Supervisor Menu under PLU.

Use these steps to recall a PLU for checkweighing.

1. If necessary, press **ZERO** to zero the scale.
2. Press and hold **SELECT**.
The active PLU flashes.
3. Key in the PLU number and press **ENTER**.
The PLU has now changed, and the indicator returns to checkweighing mode.
4. Place the item on the scale.
The indicator displays the weight, the bar graph segments change according to the tolerances set by the PLU and the backlight changes to indicate under, accept, or over.

5. Remove the item from the scale.
6. Repeat steps 4 and 5 until finished with the active PLU.



Note: Transaction counts and accumulators are stored with each PLU.

4.7.9 Standard Data Capture

Whenever the **PRINT** key is pressed the scale will print the weight along with checkweigh status **Under**, **Over**, or **Within** the Accept Weight Band.

```
OVER:      12.36 lb
OVER:      12.64 lb
UNDER:     9.72 lb
ACCEPT:    12.29 lb
```

When Auto print is enabled, the scale will automatically print once the weight is stable. This ticket can be customized to meet your full data capture requirements.

This ticket can be customized to meet your full data capture requirements.

Packrun: Packruns allows users to set a quantity of weighments before the indicator will print out the totals or if enabled along with standard deviation or X Bar/R. The packrun quantity will then control the number of transactions taken before the stats report prints. Packrun can be used to independently of other Standard Data Capture functions.

```

Acc #      1
Trans #    3
Gross Total 9000 lb
Tare Total  2000 lb
Net Total   7000 lb
  
```

Report Example

```

Tol Hi    = 0.05 lb
Tol Lo    = 0.05 lb
Target    = 3.00 lb
# Over    = 0
# Under   = 0
#Accept   = 16
Mean      = 2.84 lb
Max Wt    = 3.04 lb
Min Wt    = 0.00 lb
Std Dev   = 0.67
C of V    = 0.24 PCT
# Smpl    = 20
  
```

Standard Deviation: This statistical package controls and monitors each weight transaction and tracks all the weights each time the **PRINT** key is pressed. This allows users to see what the set Target Weights and the High and Low tolerances along with the Mean, Max, and Min recorded values. It also provides the samples taken and how many weighments fell within and outside of the Accept Window Weight. The program also captures standard deviation weight data in the background. A packrun quantity can be set to automatically print the Standard Deviation once the quantity has been reached.

1. To print the Standard Deviation Report without a set packrun, press and hold the **PRINT** key for 3 seconds.

If standard deviation is turned on, operators can get individual weights by pressing the **PRINT** key and the full statistical report when the **PRINT** key is held for 4 seconds. The samples are cleared from memory when printed. If autoprnt is enabled or the **PRINT** key is pressed a valid transaction occurs.

4.8 Checkweighing by Percentage

This section covers the ZM223 Checkweighing by Percentage app. Percentage checkweighing is dominantly used to monitor the percentage weight increase in meats when used alongside brine water injection machines.

4.8.1 Checkweighing Display Visuals

Along with the display's backlight changing color depending on how the current weight relates to the target parameters, the ZM223's display also features a fine-tuning bar graph at the top of the display that also serves to assist operators in checkweighing.

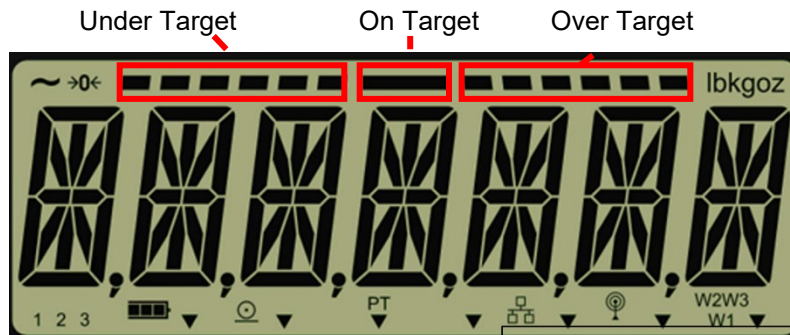

The fine-tuning bar graph can be used to quickly adjust the packed weight to be within the required Accept Percentage.

Both Under and Over bars consist of 6 segments and can be used to help the operator quickly see how close the weight is to the Accept Window. The default for each segment of both Over and Under bars equals one division %.

External Check Lights: The ZM223 can also be connected to external lights or alarms that can be set to outputs linked to the UNDER, OVER, and ACCEPT conditions. To link in and setup the ZM223 external outputs please contact an approved service provider.

Setting an Accept Window: Setting Accept Windows for all the ZM223's Checkweighing apps can only be set by either manually entering in the target % along with the upper and lower tolerance % setting using the RPN key function, using the ZM223 Remote Assist mobile app, or the web browser page.

This target % (5.00%) can also be recalled by using a preprogrammed PLU number from 1 to 500.

Red – Under the Accept Window

Green – At the Accept Window

Orange – Over the Accept Window



UNDER Target



AT Target



OVER Target



*Note: All backlight colors can be changes from within the Supervisor Menu under the **Check** and the **bcKModE** fields.*





Note: To cancel an RPN entry and return to normal operation, press the **C** key.



Note: Every ZM223 comes with a key label pack to place over a key or annunciator so it is correctly labeled.

4.8.2 Indicator Key Functions

Key	Push Duration	Function
	Press	Toggles between Gross and Percentage Weight
	Press and Hold	To enter PLU database and view and change active PLU
	Press	Zeros Scale
	Press	Sends a stable weight transaction to a Printer or PC
	Press and Hold	To Print Totals or Stat Totals
	Key in a Print Format Number and then press	Changes the active Print Format
	Press	Toggles between active units of Measure lb- kg- g -oz
	Key in an ID Number and press	Enter an ID Number
	Press	Takes the weight of the meat sample prior to going through the brine injection machine.

	Press when the scale is inside the Gross Zero Band	To view the High % and Low% Tolerances and the Target % value.
	Press	Accepts entered values

The following function can be set up as an RPN secondary key function:

- Print Formats (default **PRINT**)
- Target %
- Low tol %
- Hi tol %
- PLU
- ID (Default **UNITS**)

4.8.3 Special Key Functions



The following keys have an extra function in this application: Within this Checkweighing app the **F1** key functions as a Sample Weight key and displays the percentage as 0.0%

Operators can use the **SELECT** key to toggle between Gross and Percentage Weight.



F1/TARGET:

1. Place the meat sample on the scale prior to going through the injection machine.
2. Press the **F1 /1st SAMPLE** to establish the 1st weight sample.
The display will now revert to percentage mode
3. Run the same meat sample through the brine water injection machine and weight again once it comes out the other side.
The display will now show as a percentage (ex: 5.0%) the meat has gained based off the 1st sample weight. If the weight gain is within the required tolerance percentage band the backlight will turn Green, and the center **ACCEPT** bar of the bar graph will light up. If the weight is over the target the display will turn orange and the upper right bar graph segments, will light up.

Changing Low Tolerance %:



4. With no weight on the scale, press the **F1/TARGET** key...
Lo-Tol is now displayed
5. Press  ...
The current Low Tolerance is now displayed.
6. To change this value, key in a new value with the numeric keypad.
7. Once you have the new value set, press  to accept...
Lo-Tol is now displayed

Changing TARGET %:



8. From **Lo-Tol**, press the  ...
TARGET is now displayed
9. Press  ...
The current Target weight is now displayed.
10. To change this value, key in a new value with the numeric keypad.

11. Once you have the new value set, press  to accept...
TARGET is now displayed.

Changing High Tolerance %:

12. From **TARGET**, press the  ...
Hi-Tol is now displayed
13. Press  ...
The current High Tolerance is now displayed.
14. To change this value, key in the new value with the numeric keypad.
15. Once you have the new value set, press  to accept...
Hi-Tol is now displayed

Exit:

16. From Hi-Tol press  ...
EXIT is now displayed
17. Press  to exit the Target Menu and return to normal Checkweighing mode.



*Note: Viewing either low or high tolerances will time out after 5 seconds or when the operator presses the **F1/TARGET** key again to return the Checkweighing screen.*

4.8.4 RPN Functions and Checkweighing

An RPN function is a way to use a single key for two different functions. Each Function key can be reassigned to perform a different function subject to the app that is running. Some of these functions work within app by default.

Using RPN keys:

Key in the value using the numeric keys and then press the RPN key that has been selected for that function.

For Example: entering in a Tol low weight of 1.0%

Key in 1.2% and press the RPN activation key...

Tol low then **1.2%** will display before reverting to Checkweigh mode.

The Under/Over accept bar graph along with the backlight color will now turn on work with the new Accept Weight Tolerance bands.

4.8.5 Sample Monitoring Percentage Weight Gain

These steps apply only if the active PLU# is 0.

- 1 If necessary, press **ZERO** to zero the scale...



*Note: If motion is present for greater than 2-3 seconds after the **F1** key press, the target operation will be aborted and the word **CANT** will be displayed briefly.*

- 2 Place the item on the scale and press **F1/SAMPLE** to get the 1st Sample Weight...
Percent of item on the scale is now displayed. This should be 0.0%.
- 3 Add additional weight (for example, by injection) until the target percentage has been reached...
When the target percentage is reached, the backlight will turn green.
- 4 Clear the scale and place the next item on the scale. Repeat steps 1 and 4.

The bar graph and backlight will now show if the new item is over, under, or at the set Target Weight.



Note: By default, the Target segment lights if the weight is within \pm the high and low tolerance of the target weight. The over and under segments each represent 1 division %.

4.8.6 Using PLUs

ZM223 Indicators come standard with an internal database that can hold up to 500 PLUs or Part Look Up. PLUs are used to quickly recall saved tares and piece weights, along with other useful parameters. PLUs must be set up through a password-protected menu.

- Target %
- Under Tolerances by %
- Over Tolerances by %

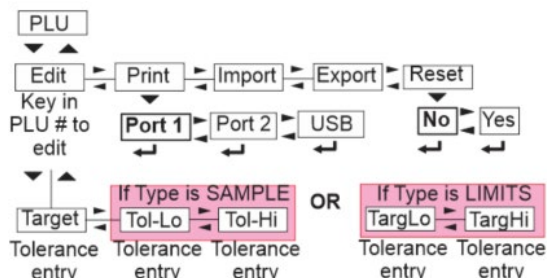

PLU 0 is a free PLU that cannot be saved over. PLU 1 to 500 hold data that can be stored and recalled even after the indicator has been turned off.

4.8.7 Recalling a Saved PLU

Follow the steps below to recall a PLU.

1. If necessary, press **ZERO** to zero the scale.
2. Press and hold **SELECT**.
The active PLU flashes.
3. Key in the PLU number and press **ENTER**.

The PLU has now changed, and the indicator returns to checkweighing mode.

4. Place the item on the scale.

The indicator displays the weight, the bar graph segments change according to the tolerances set by the PLU and the backlight changes to indicate Under, Accept, or Over.

5. Remove the item from the scale.
6. Repeat steps 4 and 5 until finished with the active PLU.



Note: Transaction counts and accumulators are stored with each PLU.

4.8.8 Standard Data Capture

Whenever the **PRINT** key is pressed the scale will print the weight along with checkweigh status **Under**, **Over**, or **Within** the Accept Weight Band.

OVER: 5.9%
 OVER: 6.1%
 UNDER: 3.9%
 ACCEPT: 4.8%

When Auto print is enabled, the scale will automatically print once the weight is stable. This ticket can be customized to meet your full data capture requirements.

Standard Deviation: This statistical package controls and monitors each weight transaction and tracks all the weights each time the **PRINT** key is pressed. This allows users to see what the set Target Weights and the High and Low tolerances along with the Mean, Max, and Min recorded values. It also provides the samples taken and how many weighments fell within and outside of the Accept Window Weight. The program also captures standard deviation weight data in the background.

1. To print the Standard Deviation Report, press and hold the **PRINT** key for 3 seconds.

If standard deviation is turned on, operators can get individual % readings by pressing the **PRINT** key and the full statistical report when the **PRINT** key is held for 4 seconds. The samples are cleared from memory when printed. If autoprint is enabled or the **PRINT** key is pressed a valid transaction occurs.

Report Example

Tol Hi	=	0.05 %
Tol Lo	=	0.05 %
Target	=	3.00 %
# Over	=	0
# Under	=	0
#Accept	=	16
Mean	=	2.84 %
Max Wt	=	3.04 %
Min Wt	=	0.00 %
Std Dev	=	0.67
C of V	=	0.24 PCT
# Smpl	=	20

Printing the Report:

Press and hold the **PRINT** key for 4 seconds, display will flash "Std-dEv Prn-tot" and the report will be printed, then the samples will be cleared from memory.



Note: To get the above report the Total Print Format must be set to 41.

4.8.9 X-Bar/R Program

The X-Bar/R program is designed to weigh process samples, establish the average weight, calculate the range between high and low weights, and the trend of deviation. If the X-Bar/R feature is enabled, the ZM223 will keep a queue of the average weights of the last eight sample sets. This queue of averages is used to print trend information on the statistical reports.



Note: The Report Printout for the X-Bar/R program can be customized to present statistical data of your choosing. This information is found in the Service manual.

1. With X-Bar/R running follow the below steps.
2. With the scale at zero, place the item on the scale.
3. When the weight is stable, press **PRINT**...
 If a printer or similar device is connected, a ticket is printed for this transaction and the transaction is stored.
4. Remove the item from the scale.
5. Repeat these steps until all items have been weighed.

- When the number of transactions reaches the specified number press and hold the **PRINT** key to print the X-Bar/R averages based on that subset, the indicator flashes **PRN-TOT** and sends the trend information to a connected device.

Trend Message	Meaning
1 of 1	The last average in the queue has an error greater than 3x the limit
2 of 3	Two of the last three averages in the queue have an error greater than the limit.
4 of 5	Four of the last five averages have an error greater than the limit.
8 of 8	Eight of eight averages are on the same side of the target weight.



Note: X-Bar/R are configured in a password-protected menu.

The print format for the total format (with trend information).

*If you want to print the trend information/totals, press and hold the **PRINT** key.*

Note: All instructions concerning an application's Setpoints are covered in the Supervisor Menu Section on [page 128](#).

4.9 Batching Application

This section covers the ZM223 Batching application. Batching allows the indicator to control up to three outputs. Using these three outputs allows the ZM223 to control connected devices (motors, timers, augers, gates, etc.) to allow for different batching configurations.

There are four types of batching operation:

- 2-speed single ingredient
- Ingredient filling (up to three ingredients)
- Independent setpoints filling
- Fill/discharge operation



Note: Other parameters, that are set in a password protected menu, affect the batching operation.



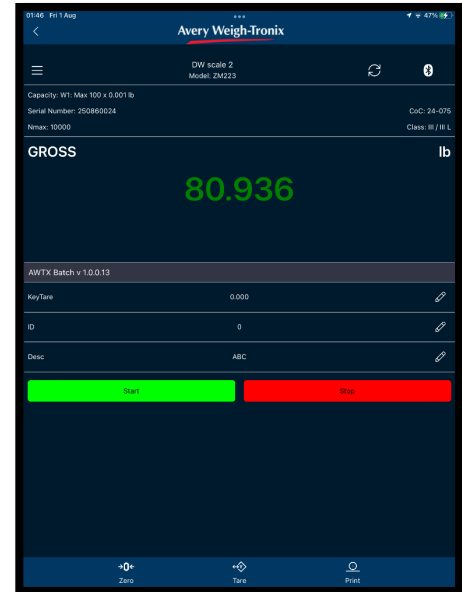



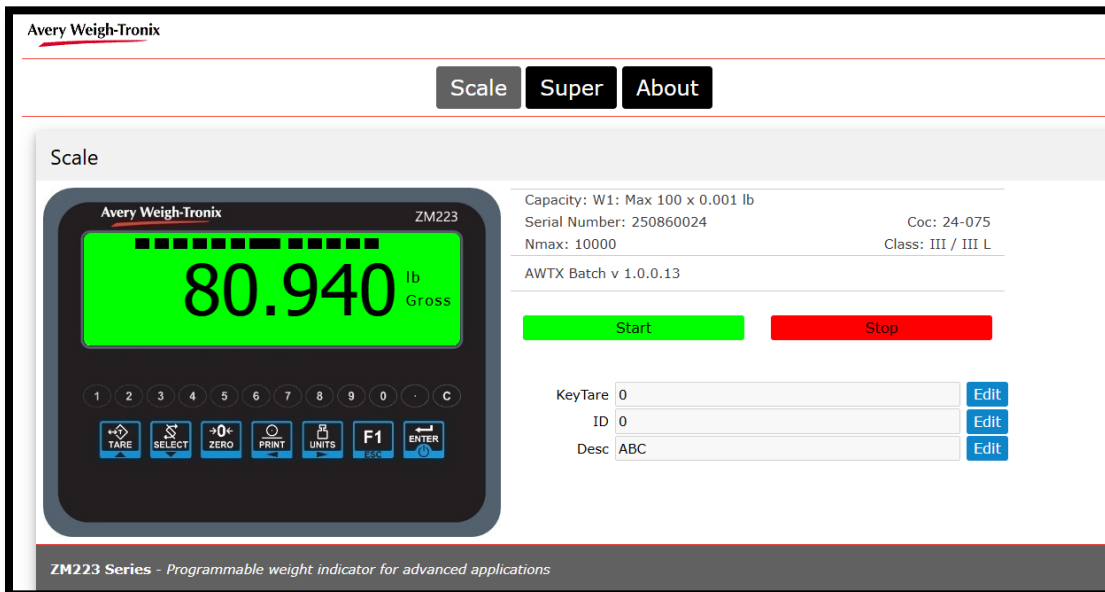

Preact: This is the amount of material in free fall after a hopper gate closes. For example: 1000 lbs of material need to be added to a scale, but when the supply valve closes it is always 120 lbs over the desired amount. To correct this, set a preact of 120 lbs. This causes the setpoint controlling the material to stop sooner and allows the material in free fall to be accounted for in the final weight. In Discharge or Negative fill applications using manual preact the preact weight will typically be entered as a negative value.



Remote Assist Batching Home Page



Web Browser Batching Home Page

Key	Push Duration	Function
	Press	Tares off box/container weight.
	Press and Hold	Clears Tare value
	Press	Toggles between Gross, Tare, Net, other display values.
	Press and Hold	Access Output Values (Target's 1, 2, 3 and Pre-Act's 1, 2, 3)
	Press	Zeros Scale
	Press	Sends a stable weight transaction to a printer or PC
	Press	Toggles between active units of Measure lb, kg, g, oz
	Press	START and a STOP
	Press	Accepts entered values – turns on scale when off

The following function can be set up as an RPN secondary key function:

- Print Formats (Default **PRINT**)
- I/O 4
- I/O 5
- I/O 6
- Preact 4
- Preact 5
- Preact 6
- ID (Default **UNITS**)

4.9.1 Special Key Functions

The following keys have an extra function in this application: Within the Batching app the **F1** key functions as the **START** and **STOP** key. Operators can use the **SELECT** key to toggle between Gross, Net, and Tare weights.



4.9.2 2-Speed Filling

The 2-Speed Filling Application is for a single ingredient with a dual speed (Fast/Slow) filling control. This is typically accomplished by a valve or hopper gate that can be fully open (Fast), partially open (Slow), or closed (Stopped). When the fill starts both I/O 4, I/O 5, and I/O 6 are turned on (outputs activated) which should set the dual speed control to full open (Fast). When the I/O 4 value is reached I/O 4 is turned off and this should set the dual speed control to partial open condition (Slow). When I/O 5 value is reached I/O 5 and I/O 6 are turned off to close the control device and complete filling. I/O 6 can be used for a Batch Cycle Active indicator.



Note: I/O 1 is defaulted to the F1 key.

Press and hold **SELECT** to access the setpoint editor.

1. Set Target 1 to the fast fill value and Target 2 to the slow fill value. For example, when filling a product to 100 lb. with the last 5 lb. on slow fill: Target 1 should be set to 95 and Target 2 & Target 3 should be set to 100.
2. To start the filling process, press **F1**...
StArt? is now displayed. Press the  key to start the process or **ESC** button to abort.
3. To pause the filling process, press **F1**...
PAuSE is now displayed.
4. To resume the batch, momentary press **F1**...
RESumE? is now displayed; press the  key to resume

OR

Press  ...

StoP? is now displayed. Press  to stop the process.

If preacts are used, the preacts are tied to the Output Target. Follow the below steps to set Output Targets.

1. Press and hold the **SELECT** key.
2. Press  to toggle through Preact 1, 2, and 3.
3. Preacts can be set to Manual or Automatic.
4. SDet the preact to the amount expected to be in free fall so the indicator will now compensate for that expected free fall by switching the output off sooner.





4.9.3 Ingredient Filling

Ingredient filling is for batching up to 3 different ingredients controlled by the values of Target 1, 2, and 3. If Target 2's value is 0 then it operates as a single ingredient filler. If Target 3's value is 0 then it operates as a 2-ingredient batcher.

1. Press and hold the **SELECT** key to access the setpoint editor.
2. Set Target 1 to ingredient 1's value, Target 2 to the ingredient 2's value, and Target 3 to the ingredient 3's value. See more details on Gross or Net weight batching in (on [page 77](#))
3. To start or restart the batching process, press **F1**.
The display changes to green to show that filling has started.
4. To stop the batching process, press **F1**.
The display will change to red to show the process has been paused.
5. To restart filling, press **F1** again...
The display will ask **resume?**
6. Press  to restart filling.

4.9.4 Independent Setpoints

Independent Setpoint works like the general weighing mode setpoints with the addition of start/stop controls. Negative weight/discharge numbers are also available when using this mode.





1. Press and hold the **SELECT** key to access the setpoint editor.
2. Set Target 1, 2, & 3's values.
3. Press **F1** then  to start the process.
The backlight will turn green to show the process is running
4. To pause the process, press the **F1** key.
The backlight will turn red to show the process has been paused.
5. To resume the process, press the **F1** then the  key...
The backlight will turn green to show the process has resumed
6. To abort the process while paused, press the **F1** key and then press  until **StoP?** is displayed, then press the  key...
The backlight will turn yellow to show that process is no longer running.

4.9.5 Fill/Discharge

Fill/Discharge mode is typically used for manual applications that use negative filling to dispense a smaller amount of product from a large vessel, tank or hopper type scale. The vessel (tank or hopper) is filled to a set gross weight and then multiple operations of filling via negative amount of weight into bags or containers can be completed before the vessel (tank or hopper) requires a recharge or refill.

Fill I/O 4 (Target 1): is assigned as the gross fill amount for the vessel (tank or hopper) and F1 key starts the fill. The fill is based only on gross weight. If Target 1 is set to 2000 and the scale already has 500 lb remaining, the Target 1 will cut off when the additional 1500 is added for a total gross of 2000 lb.

Discharge I/O 5 (Target 2): is assigned as the discharge fill amount (negative weight) with the TARE key used to initiate the discharge cycle. Now tare the scale prior to activating Target 2 an operator can perform multiple discharge operations. When the vessel gross weight is low, the operator will perform a manual refill.

1. Press and hold **SELECT** to access the setpoint editor.
2. Set Target 1 to the gross fill weight in the vessel or container. Set Target 2 to the weight of the product to be discharged into smaller bags or containers.
3. To start the process, press **F1** then the  key.
The backlight will change from yellow to green to show the process is running. Once the filling process level has reached the process will turn off Output 4 and wait for the manual dispensing to start. The backlight will turn red to show the process is now paused.
4. Press **TARE** to start the filling/discharge process...
The backlight will turn green while the bag/container is being filled.
5. Once finished Output 2 turns off and the backlight will change to yellow until the next bag is ready to be filled.
6. Repeat step 4 until the hopper is close to empty
7. To pause the process, press **F1**...
The backlight will turn red to show the process has been paused.
8. To resume the process, press the **F1** then the  key...
The backlight will turn green to show the process has resumed
9. To abort the process while paused, press the **F1** key and then press 
until **StoP?** is displayed, then press the  key...
The backlight will turn yellow to show that process is no longer running.

4.9.6 Notes on Batching

2 Speed Filling

- **MODE** settings do not apply to Fill/Discharge
- If **DISP** is set to NET, the display will remain in net weight mode after the discharge cycle has finished.
- If **DISP** is set to GROSS, the display will remain in gross weight mode after the discharge cycle has finished.
- If **DISP** is set to NET-A, auto tare will be performed, and the display will switch to gross weight mode after the discharge cycle showing what is left in the vessel.
- If **PREACT** is set to **AUTO** it only applies during the Target 2 discharge cycle.
- **NEG FILL** setting does not apply to Fill/Discharge
- If **NEG FILL** is set to YES, then DISP should be set to Net so that an autotare occurs prior to start and the cutoffs will be based on negative entered values for I/O 4 (Target 1) and I/O 5 (Target 2).
- I/O 3 (input) and I/O 6 (Target 3) are used as the Active Batch Cycle indicator in 2 Speed filling



Note: If the **F1** button is pressed during the batch cycle, the current ingredient fill will be terminated and the batch cycle will continue to the next ingredient fill.

Ingredients:

- If **MODE** is set to **AUTO**, the batch process will continue until the final ingredient is completed. Between each ingredient there will be a slight delay to allow for motion, final weight and preact calculations.
- If **MODE** is set to **MANUAL**, press **F1** between each ingredient to complete the fill cycle.
- If **MODE** is set to **MANUAL** and **DISP** is set to **NET**, press **TARE** between each ingredient before pressing **F1** to fill the next ingredient.
- If **MODE** is set to **AUTO** and **DISP** is set to **NET**, an autotare will occur prior to each ingredient and the Target 1, 2 and 3 (I/O 4, I/O 5 & I/O 6) fill weights will be based on Net weight.
- If **DISP** is set to **GROSS**, no autotare will occur and the Target 1, 2 and 3 (I/O 4, I/O 5 & I/O 6) fill weights would be based on the Gross weight of the accumulated ingredients. For example, if Ingredient 1 amount is 10, Ingredient 2 amount is 20 and Ingredient 3 amount is 30 then enter would enter I/O 4 = 10, I/O 5 = 30 (10 + 20) and I/O 6 = 60 (10 + 20 + 30). Output cutoffs are based on the actual displayed Gross Weight so if inaccurate amounts of ingredient are experienced during the batch, then it may affect the amount of each subsequent ingredient that is added.
- If **PREACT** is set to **AUTO**, then it will be calculated for each ingredient to adjust the cutoff weight accordingly.
- If **NEG FILL** is set to **YES**, it will only operate for a single ingredient with I/O 4 used for discharge filling based on negative weight.



Note: All instructions concerning an application's Setpoints are covered in the Supervisor Menu Section on [page 132](#).

4.10 Peak Hold Application

This section covers the ZM223 Peak Hold application. In certain production processes, testing force is required to understand product performance. The ZM223 indicator can weigh up to the failure point and hold the peak weight value of the unit before it breaks giving an accurate failure tolerance, all while recording the weight data in the background.

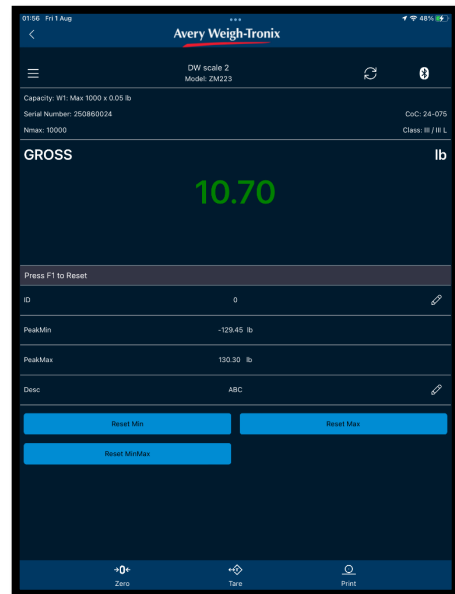



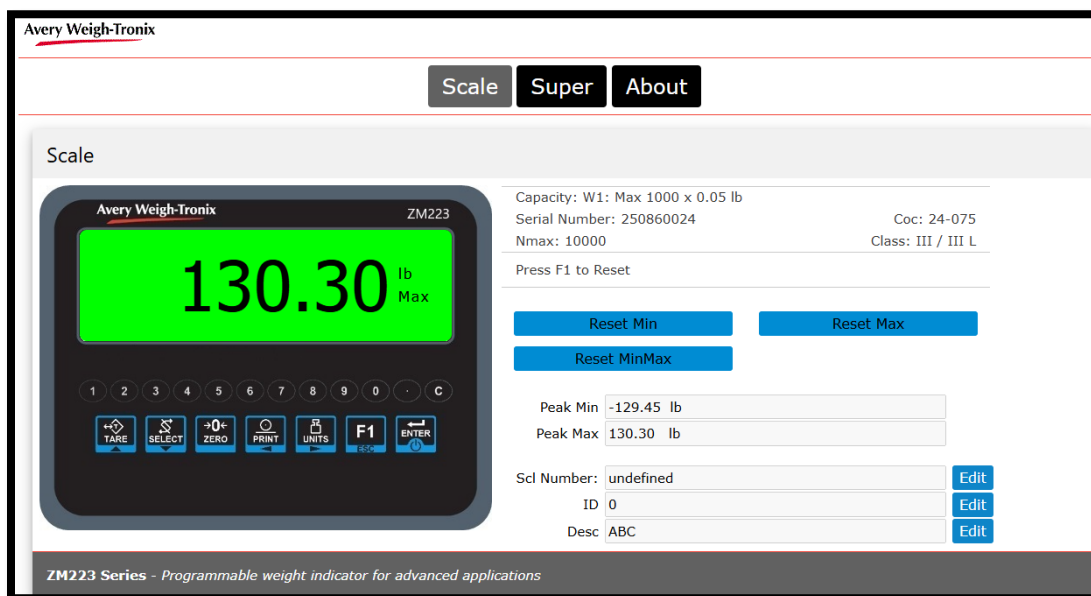



Remote Assist Peak Hold Home Page



Web Browser Peak Hold Home Page

4.10.1 Indicator Button Functions

Key	Push Duration	Function
	Press	Changes from Gross weight to the minimum recorded weight and then the maximum recorded weight.
	Press and Hold	Access I/O 4, 5, and 6 values.
	Press	Zeros Scale
	Press	Sends a stable weight transaction to a printer or PC
	Press	Toggles between active units of Measure lb, kg, g, oz
	Press	Resets the min and max peak weights to the current gross weight.
	Press	Accepts entered values – turns on scale when off

The following function can be set up as an RPN secondarily key function:

- Print Formats (Default **PRINT**)
- I/O 4
- I/O 5
- I/O 6
- ID (Default **UNITS**)

4.10.2 Special Key Functions

The following key has an extra function in this application:

F1 resets the min and max peak weights to the current gross weight.

In the Peak Hold application users can view the gross, max, and min display values by repeatedly pressing **SELECT**

Additionally, when in normal operation the user can hold down the **SELECT** key to enter a quick edit mode for the I/O 4 - 6 values.

4.10.3 Peak Hold Operation

Only the highest weight applied to the scale is displayed when the peak weight value is selected to be displayed via the Minimum and Maximum weight display annunciators.

With the Peak application active, follow these steps to perform and view peak weighments.

1. Repeatedly press **SELECT** until the annunciators on the right of the display light up.
This is the peak or maximum weight.
2. With no weight on the scale, press **ZERO**, if necessary, press **F1** to reset any previous peak value on the display.
3. Apply force or weight to the product until it fails.
The display will show the peak weight recorded during the weighment.
4. To reset the peak, press **F1** ...
5. The minimum and maximums are reset to the current gross weight.
6. Repeat these steps to perform another peak weighment.

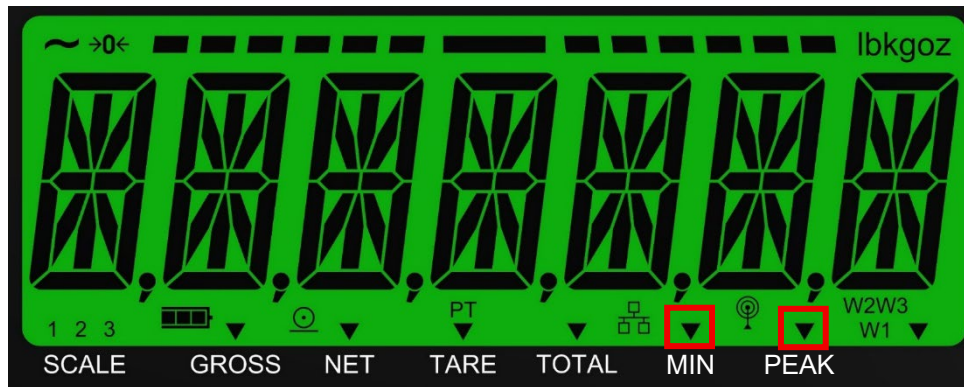

The Peak Annunciator is displayed in the figure above. Add the “PEAK” and “MIN” labels from the label pack to the indicator’s display to help with operator.

4.11 Remote Display Application







This section covers the ZM223 Remote Display app. The indicator can be configured to work as a remote display with all other ZM series indicators. The ZM223's Remote Display Application can be used as a Remote Display Indicator for a Primary Indicator through RS232 or Ethernet connection. See [page 188](#) for full setup information. Furthermore, the main function keys (Tare, Zero, Print, and Units) on the remote display indicator will function normally.

The Remote Assist Mobile App can also be connected to the Remote Display Indicator allowing for the same weight readings to displayed on a mobile device.



Note: When using the Remote Assist Mobile App to view a live weight, the mobile app keys will not work in this setup. Because the app is connected to the Remote Display Indicator it just provides a remote live weight display.

To use a ZM223 to function as a remote display for a separate Primary Indicator the user must configure settings in the Supervisor Menu and the Configuration Menu.

Key	Push Duration	Function
	Press	Sends a Tare command to the primary indicator to tare off the box/container weight.
	Press and Hold	Sends a Clear Tare command to the primary indicator to clear the active tare weight.
	Press	Sends a Select command to the primary indicator to toggle between Gross, Tare, Net, weights.
	Press	Sends a Zero command to the primary indicator to zero the scale.
	Press	Sends a Print command to the primary indicator to print a stable weight transaction to a printer.
	Press	Reset the Max and Min weights
	Press	Sends a Units command to the primary indicator to toggle between active units of Measure lb, kg, g, oz.

4.11.1 SELECT Key Default Function

Pressing the **SELECT** key allows users to cycle through and view the Gross, Net, Tare, Gross Total, Net Total, and Transaction Count display values. This only applies when the scale is within the gross zero band.

- When the Gross Total is displayed, both the GROSS and TOTAL annunciators will be lit.
- When the Net Total is displayed, both the Net and Total annunciators will be lit.
- When the Transaction Count is displayed, the custom annunciator will be lit. Add the provided Transaction Count sticker to the display.

4.12 In-Motion Application

This section covers the ZM223 In-Motion Weighing app. In-motion weighing involves items moving across conveyor scales that use Entrance and Exit photo-eyes to track when an item moves on and off the conveyor scale to calculate a weight for that item. When the item is completely past the beam of the Entrance photo-eye the weight capture starts at the ADC rate of 80 samples per second. When the item breaks the beam of the Exit photo-eye the weight capture stops, and the average of all the weight readings is displayed for a configured length of time or until the next item breaks the beam of the entrance photo-eye.

Motion weighing annunciator

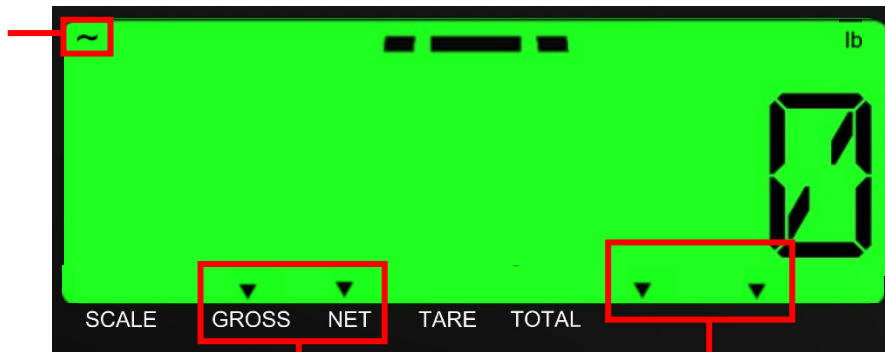





GROSS or NET annunciator will signal depending on if a Tare value is active





In-Motion Annunciators

The average weight value will “print” when the exit photo eye is tripped. If the averaged weight timer expires before the next item arrives the indicator will show dashes across the middle of the display.

Below is a guide that will show how to setup/configure the ZM233 In-Motion Check-Weighing application using Entrance and Exit photo-eyes and using the setpoint outputs for the Under/Accept/Over control signals.

4.12.1 Indicator Key Functions

Key	Push Duration	Function
	Press	Tares off box/container weight.
	Press and Hold	Clears Tare value
	Press	Toggle between gross weight and the in-motion weight
	Press and Hold	Access I/O 4, 5, and 6 values.

	Press	Zeros Scale
	Press	Sends a stable weight transaction to a printer or PC
	Press	Toggles between active units of Measure lb, kg, g, oz
	Press	
	Press	Accepts entered values – turns on scale when off

4.12.2 Special Key Functions

The following key has an extra function in this application:

Pressing the **SELECT** key allows users to cycle through and view the Gross, Net, Tare, Gross Total, Net Total, and Transaction Count display values. This only applies when the scale is within the gross zero band.

- When the Gross Total is displayed, both the GROSS and TOTAL annunciators will be lit.
- When the Net Total is displayed, both the Net and Total annunciators will be lit.
- When the Transaction Count is displayed, the custom annunciator will be lit. Add the provided Transaction Count sticker to the display.

Additionally, when in normal operation the user can hold down the **SELECT** key to enter a quick edit mode for the I/O 4 - 6 values. This only applies to the ZM223 Indicator Apps that allow for I/O configuration.

4.12.3 In-Motion Operation

When setting up the In-Motion App it may be helpful to think about what each I/O is specifically controlling on the conveyor scale.

- I/O 1 is connected to the Entrance photo-eye and a positive edge signal will start the weight averaging.
- I/O 2 is connected to the Exit photo-eye and a positive edge signal will stop the weight averaging.

For In-Motion Checkweighing:

- I/O 4 will control the Under setpoint and must be set to ACT IN (Active Inside)
- I/O 5 will control the Accept setpoint and must be set to ACT IN (Active Inside)
- I/O 6 will control the Over setpoint and must be set to ACT ABV (Active Above).



Note: The setpoint outputs can be connected directly to a light stack or to external relays or opto modules to control the routing of the item after exiting the conveyor.

4.12.4 In-Motion Checkweighing Operation

1. Press the **SELECT** key until the bottom right 2 LED's are illuminated
2. Start the conveyor
3. When an item triggers the entrance photo-eye the display will

show 

4. When the item triggers the exit photo-eye the display will show the calculated average weight and the appropriate check-weigh setpoint output will activate for the length of the DELAY timer or until the next item passes the entrance photo-eye.
5. If the DELAY timer expires before the next item arrives the display will show center dashes

Additional Notes: Checkweighing is based on Net weight. Tare weight is allowed.



Note: All instructions concerning an application's Setpoints are covered in the Supervisor Menu Section on [page 132](#).

4.13 Grading Application

This section covers the ZM223s Grading app. Grading is a useful function that allows users to classify a range of weights as “grades” to help improve processes that require weighing large quantities of items with irregular weights. For example, any weight below weight point #1 or above weight point #11 will be displayed as weight. Any other weight will be shown as one of the 10 Grades. The display will show grAd X, with X being the grade number for that weight. Remove the item from the scale and weigh the next item. A running accumulated total per grade (total weight per grade plus the number of transaction per grade) is captured and can be printed when needed.



Note: You can reduce the number of grades by setting Grad Points to 0. For example: To create 3 grades, set Grad Points 1, 2, 3 and 4 normally (4 being the top of the Grade point 3). Set Grad Points 5 through 11 to 0.

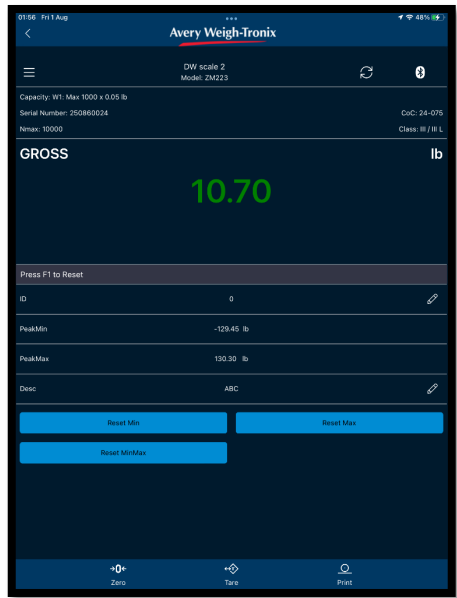

Remote Assist Grading Home Page

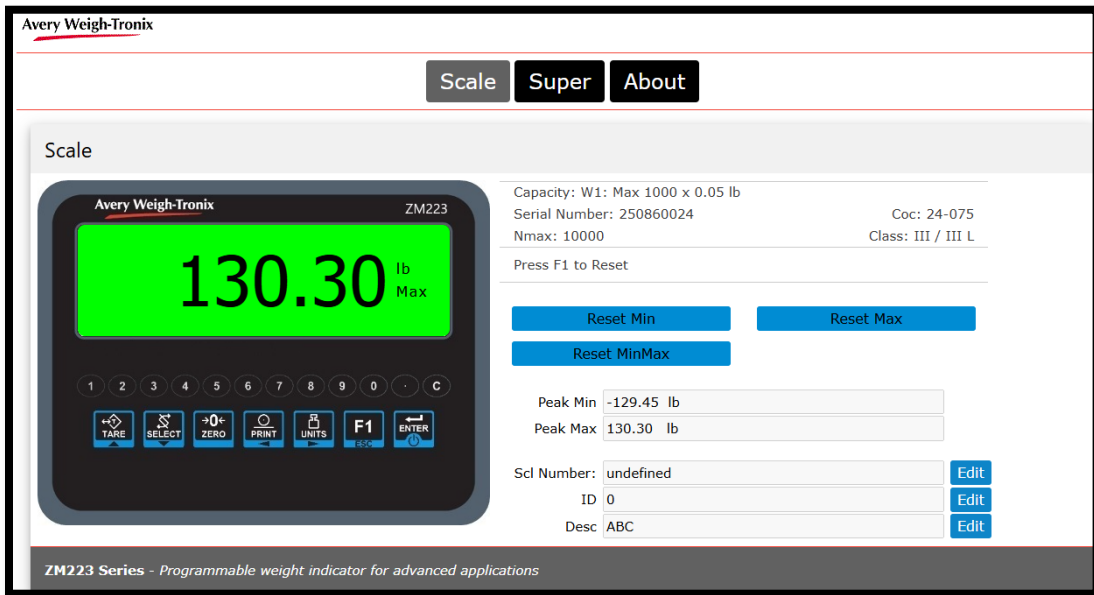

Web Browser Grading Home Page





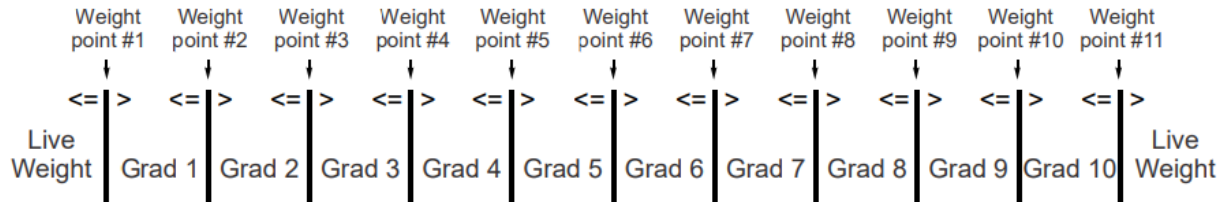

4.13.1 Grade Classifying



Grade classifying is the same whether the unit is configured for positive or negative grading. Set the weight values for each division between the grades. If the weight on the scale falls below or is equal to the weight value of a grade division, it is in the grade below the line. If it is greater than a weight value, it is in the grade above the line. The default value for Weight Points 2 through 10 is 0.

It is critical to note that when setting a grade range the WHOLE scale division is included in that grade. For example, if each scale division is 1.001 lb set Grade 1 to 1.000 lb and Grade 2 to 2.000 lbs then anything from 1.001lb to 2.001 lb is classed as Grade 1. If you wanted to have Grade 2 trigger at 2.000 lbs then it would need to be set to 1.999 lbs.



4.13.2 Indicator Key Functions

Key	Push Duration	Function
	Press	Tares off box/container weight.
	Press and Hold	Clears Tare value
	Press	Toggles between Gross, Tare, Net, other
	Press and Hold	Access I/O 1 - 6 values.
	Press	Zeros Scale
	Press	Sends a stable weight transaction to a printer or PC
	Press and hold	Prints and then clears accumulator totals

	Press	Toggles between active units of Measure lb, kg, g, oz
	Press	Allow users to set up and view all the grades from 1 to 11.
	Press	Accepts entered values – turns on scale when off

The following function can be set up as an RPN secondary key function:

- Print Formats (Default **PRINT**)
- Grade 1
- Grade 2
- Grade 3
- Grade 4
- Grade 5
- Grade 6
- Grade 7
- Grade 8
- Grade 9
- Grade 10
- Grade 11
- ID (Default **UNITS**)

4.13.3 Special Key Functions

The following keys have an extra function in this application:

With Grades defined, press **F1** to view or edit the values associated with the Grades.

Operators can use the **SELECT** key to toggle between Gross, Net, and Tare weights.

4.13.4 Positive vs. Negative Grading

The ZM223 can be configured for positive or negative grading. Positive grading classifies a weight as 1 of 10 weight grades.

Negative grading is used to classify objects removed, one at a time, from a full tote or box. The process is described in Negative grading with Autotare enabled on [page 199](#).

4.13.5 Setting Weight Grades

Grades are set up under the Supervisor Menu. Once they are set up, in regular weighing mode, users can press **F1** to view or edit the values for Grades 1 - 11. (This works regardless of whether the scale is at zero).

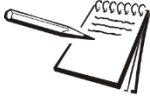

Note: When grades are set in the Supervisor Menu they will be saved to be used after the indicator is turned off.

Setting Weight Grades

1. With the Grading application active, press **F1**.
GRADING is displayed.
2. Press **←** ...
GRAD 1 is displayed. This is the first weight point that defines the lower limit of GRAD 1
3. Press **←** ...
The current First Grade value flashes indicating that you can edit this.
4. Key in the weight for this and press **←** ...
The indicator returns to **GRAD 1**.
5. Press **▶** to move to the next grading weight point.
The next **GRAD** point is displayed.
6. Repeat steps 3 – 5 until all grade weight points have been set.
7. Once all the GRAD points have been entered, press **▲** multiple times to exit and return to weighing.

4.13.6 Negative Grading with Autotare Enabled

If your unit is configured for negative grading with autotare enabled, follow these steps. Negative Grading is enabled in the Supervisor Menu.

1. Zero the empty scale, if necessary.
2. Place a tote or box loaded with the items to be graded on the scale...
3. For the first weightment the operator needs to press the **TARE** key to initiate autotare. All following weightments will be automatically tared off.
4. Remove an item...
The grade of the removed item is shown for 0.5 seconds and the scale autotares. If the removed item weight is less than the grade 1 value the scale will still perform the autotare when stable.
5. Repeat step 3 until all items have been graded.
6. Remove the tote and repeat steps 1 through 4.

4.13.7 Negative Grading with Autotare Disabled

Negative Grading works by taking the total weight of a container of items on the scale and subtracting the weight of a removed item to Grade the removed item. This feature can reduce steps when used correctly in processes like dispensing out of a larger bulk container.

If a ZM223 is configured for negative grading with autotare disabled, follow the steps below:

1. Zero the empty scale, if necessary.
2. Place a full container on the scale and press **TARE**...
The scale should read **0**.
3. Remove an item...
The grade of the removed item is shown.
4. Press the **TARE** key.
5. Repeat step 3 until all items have been graded.
6. Remove the tote and repeat steps 1 through 4.



Note: All instructions concerning an application's Setpoints are covered in the Supervisor Menu Section on [page 135](#).

4.13.8 Removing the Last Graded Weight from the Accumulator Totals

Occasionally the weight of more than one product is registered by the scale resulting in an incorrect grade weight so removing the last Graded weight from the Accumulator totals is a common practice when negative grading.

If this happens use the **RPN ACUM** - (any number followed by the correct RPN key) to remove the last from the Accumulator grade totals.



*Note: **ACUMM-RPN** can be turned on under the Supervisor Menu under RPN.*

4.13.9 Recording Grade Totals

There are two ways to add a Grade to the Grade Totals: Manual and Automatic.









When set to Manual, each time the **PRINT** key is pressed the last Grade Weight will be added to the Grade Band Total along with the number of transactions.

When set to Automatic, each item's weight data is added to the total upon being graded to automatically record once the weight is stable.

4.14 AutoLoc Application

AutoLoc is specifically designed for use in weighing livestock. Once the indicator has determined the animal's weight, the indicator automatically locks on that weight, and the weight reading will not change as long as the animal is on the scale. This makes the weight easy to record since the numbers do not rapidly change as the animal moves around on the scale.

4.14.1 Indicator Key Functions

Key	Push Duration	Function
	Press	Tares off box/container weight.
	Press	Toggles between Gross, Tare, Net, other
	Press	Zeros Scale
	Press	Sends a stable weight transaction to a printer or PC
	Press	Toggles between active units of Measure lb, kg, g, oz
	Press and hold	Rechecks the weight and removes the previous weight from the memory channel.
	Press	Unlock the weight.
	Press	Accepts entered values – turns on scale when off

4.14.2 AutoLoc Operation

Standard Mode

1. Turn the indicator on, press the **SELECT** key to access gross mode
2. Press the **ZERO** key.
3. Move the animal onto the scale.
4. WWWW is shown, the AUTO annunciator turns on, the display turns red and shows the animals AutoLocked weight.
5. If auto-accumulate is on, once the weight is locked-on, the ZM223 will automatically accumulate to the last selected memory channel.
6. The weight stays locked until the weight on the scale drops by the programmed release tolerance. (Example: weighing a 2000 lb animal with a 25% release tolerance, means the lock will release when weight drops below 1500 lb).
7. If the animal is released and the weight falls below the tolerance it may be possible to lock on another weight. We recommend putting in a high release tolerance like 75% to ensure reliable operation.
8. To prevent an inadvertent AutoLoc (Ex: someone leans/steps on the scale), we recommend setting the **ALC MiN** parameter to 50% of the expected average animal weight.
9. Remove the animal from the scale. Scale returns to live weighing mode
10. Repeat steps 2 and 3 for every animal.
11. When a false locked weight occurs, either: the **F1** key to unlock the displayed weight and reweigh the animal.

OR

To remove an accumulated weight from an accumulated value press and hold **UNITS** key to recheck the animal's weight and to remove last weight from the memory channel. This will also delete from the accumulators the last locked-on weight and replace it with the new locked-on weight.

Advanced Mode

The following describes how the ZM223 can be used for weighing and recording animal's weight automatically on a single animal livestock scale using the advanced AutoLoc mode. The indicator must be set up for AutoLoc and set for advanced (**AdvANCE**) mode. The ZM223 will lock on an animal's weight and stay locked even after the animal is off the scale. A new AutoLoc weight will only be retriggered upon placing the next animal on the scale.

4. Turn the indicator on, press the **SELECT** key to access gross mode
5. Press the **ZERO** key.
6. Move the animal onto the scale.
7. WWWW is shown, the AUTO annunciator turns on, the display turns red and shows the animals AutoLocked weight.
8. If auto-accumulate is on, once the weight is locked-on, the ZM223 will automatically accumulate to the last selected memory channel.
9. To prevent an inadvertent AutoLoc (Ex: someone leans/steps on the scale), we recommend setting the **ALC MiN** parameter to 50% of the expected average animal weight.
10. Remove the animal from the scale. When in Advanced Mode the AutoLoc reading will stay on the display until another animal walks onto the scale. This was designed to help with record keeping.
11. Repeat steps 2 and 3 for all animals.

12. When a false locked weight occurs, either: To just unlock the displayed weight and reweigh the animal, press the **F1** key to unlock the indicator to recheck the animal's weight

OR

To remove an accumulated weight from an accumulated value press and hold **UNITS** key to recheck the animal's weight and to remove last weight from the memory channel. This will also delete from the accumulators the last locked-on weight and replace it with the new locked-on weight.

5 Remote Assist Mobile App Walkthrough

This section covers the free Avery Weigh-Tronix Remote Assist mobile app that pairs with any ZM223 via Bluetooth. Remote Assist provides users with additional features to make the indicator more flexible. Using the Remote Assist app users can: remotely view live weights, use some of the indicator keys, view and change a wide range of app defined weight data fields, change UDF printable text fields that can be used on a print ticket or label, and use operator prompts to aid in using the ZM223. Subject to the app running on the ZM223, special fields can be viewed and used in the Remote Assist mobile app. However, it is recommended to keep these active fields to around 6 to reduce the risk of slowing down the Remote Assist mobile app. The Remote Assist mobile app is available in Android, IOS, and Windows formats and can be downloaded using the QR code below or directly from the Google Play or Apple App Store.

5.1 Remote Assist Mobile App Breakdown

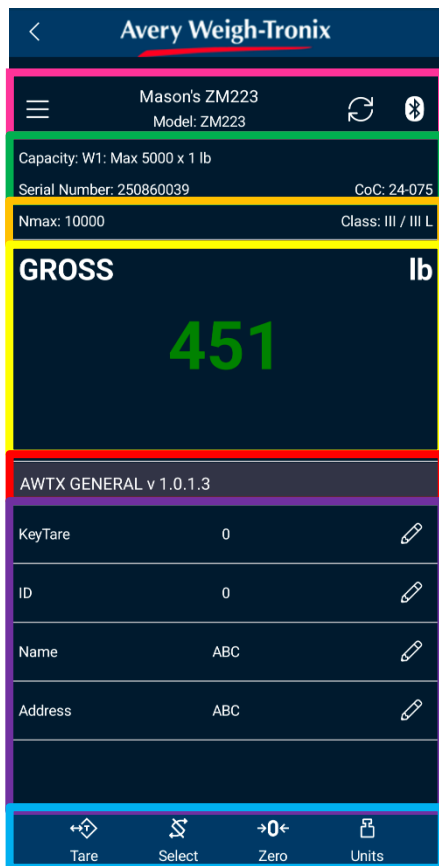

Menu button, Scale data, Refresh button, and Bluetooth icon.

Device Settings, Name, Model, Connection Type – (Firmware Driven)

Scale Device Info: Capacity, Serial Number, Etc. – (Firmware Driven)

Active Value, Weight, and Units – (Firmware Driven)

User Prompt - (App Driven)

UDF (User Defined Fields) + Custom App Buttons – (App Driven)

- Driven using LUA Variables
- Define which values you want displayed and their order.
- Variable description, value, and read/write status is show.
- Define custom buttons and colors.

Device Keys/Remote Keys – (Firmware Driven)

5.2 Downloading the Remote Assist Application

Download the Remote Assist Mobile App to any smartphone or tablet from either the Google Play Store or the Apple App Store by searching "AWTX Remote Assist."

1. Follow the normal app download procedure.
2. Once downloaded, tap the R-Assist icon shown below to launch the application.



5.3 Connecting a Scale

1. Tap the R-Assist application icon
2. Tap "Add Bluetooth Device"

Choose Start scanning: select the Serial Number that corresponds to the desired ZM223 Indicator

OR

Use QR code on the back of the indicator be sure to scan the Bluetooth Connection sticker on the back right hand side of the indicator.



3. Name the device, while being sure to maintain an easy to remember naming convention.



Note: We recommend that users maintain a reliable naming convention for all ZM223 units. For example, if there are four production lines (Named: Line A, Line B, Line C, and Line D) that are getting four ZM223 units, name each unit the same as the line it is installed on so when connecting to an indicator through Remote Assist you will see Line A, Line B, Line C, and Line D.

4. Tap the OK button and the mobile device is connected to the ZM223 Indicator

5.4 Mobile App Screen Navigation

To navigate between the menus of the Remote Assist application use the Navigation Popup menu.

To access the Navigation Popup menu, tap the Navigation Button on the upper left-hand side of the home screen.



Note: The Navigation Button will be in the same location on every page of the Remote Assist Mobile App. Subject to the app that is running in the ZM223, some fields, like reports, may not be available in the app.

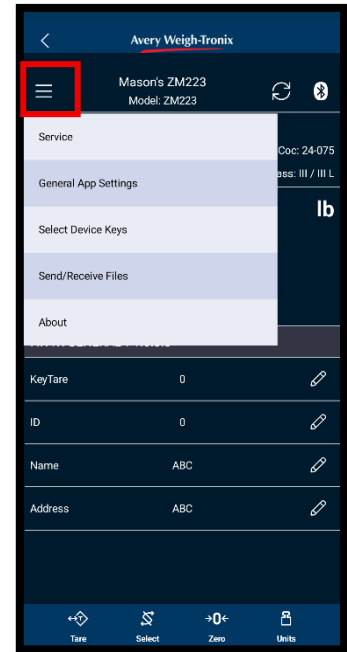

5.5 Scale & UDF Fields Seen in the Remote Assist Mobile App

Depending on the ZM223 app that is running in the indicator, will determine the scale fields that are available for the Mobile phone to use.

All fields are fully controlled directly from the ZM223 application running in the indicator or by enabling or disabling on the mobile app from the ZM223 Supervisor Menu.

Configuring these fields to be On or Off is all done from the Mobile Menu under the Supervisor Menu (see [page 207](#)).

5.6 Using the Active Scale Fields from the Remote Assist Mobile App

Different ZM223 apps use different mobile app features.

For example, in checkweighing the live weight color also represents if the weight is within the Accept / Under / Over states.

Orange: Over

Green: Accept

Red: Under

In the Batching application however, Green identifies the process is running and Red identifies that the process has been paused.

Green: Process is running

Red: Process Paused

Each of the scale fields that are enabled in the mobile app are used to provide clear visuals of the process parameters.

Adjusting any fields with a pencil icon can be done remotely from the mobile app. To do this simply:

1. Tap on the pencil icon area of the Remote Assist mobile app screen.
2. The popup window is now displayed for that scale field.
3. Type in your new value or description and tap the "Save" button in the middle of the popup window.
4. The new value will be saved in the indicator and the Scale Field box in the Remote Assist mobile app screen will show the changed data.



Note: If you enter the Supervisor menu on the ZM223 Indicator when you return to live weight mode, it is recommended that you press the "Reconnect" key on the top right of the Remote Assist app screen. This ensures all new parameters are loaded correctly in the mobile app.



Note: Digit colors in the Remote Assist app match those of the backlight settings in the ZM223.

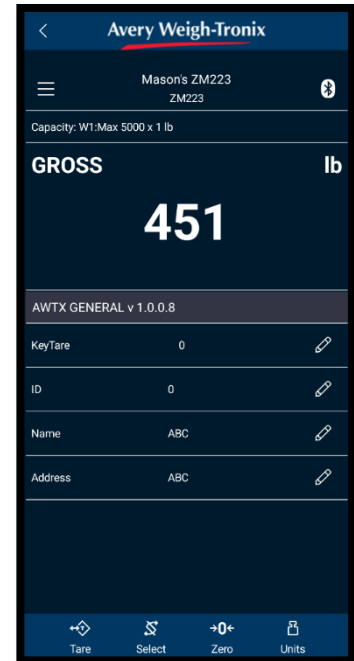

5.7 Text Prompt Messaging

In some applications, the text prompt window area on the Remote Assist app screen is used to provide additional operator instructions or acknowledgements when certain steps in the process have been reached.

These messages are built into the ZM223 Indicator application running in the indicator.

5.8 Mobile App Settings

Under the Application Settings Menu users have access to the following fields:

- Include date on stored transactions
- Include time on stored transactions
- Auto Reconnect
- CSV Export Formats
- Select Language

Auto Reconnect automatically connects the mobile device to a previously paired indicator. If Auto Reconnect is active it may be difficult for another mobile Bluetooth device to gain connection.



Note: The Application Setting Menu also contains links to Avery Weigh-Tronix Privacy Policy and End User License Agreement.

To save changes to the Remote Assist App Settings, make the desired changes and then tap the “OK” button on the lower left-hand corner of the screen shown below.

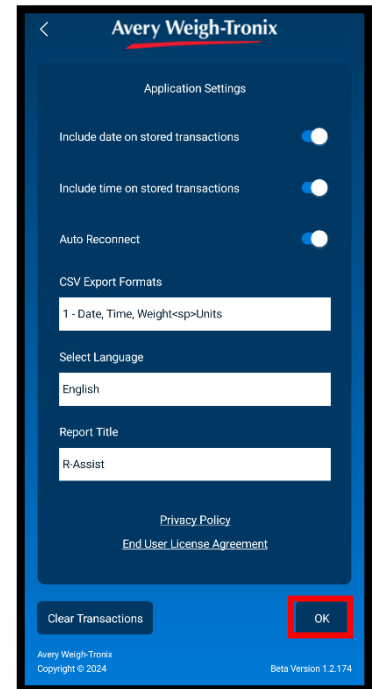

5.9 Customizing Home Screen Keys

Under the Select Device Key page, users can select what indicator keys and functions that appear on the Remote Assist home screen as well as their order.

Tap the arrow symbols to change the order (from left to right) the buttons will be in on the Home Screen.

Tap the plus button next to any of the keys under the Available Device Keys to add them to the Home Screen buttons.

Tap the minus symbol next to any of the buttons under the Selected Device Keys to remove them from the Home Screen.

The available keys are:

- Tare (default)
- Select (default)
- Zero (default)
- Units (default)
- Print
- Export (exports the stored live weights captured to a CSV or Excel file)
- Store (saves live weight readings from the indicator inside the Remote Assist Mobile App)

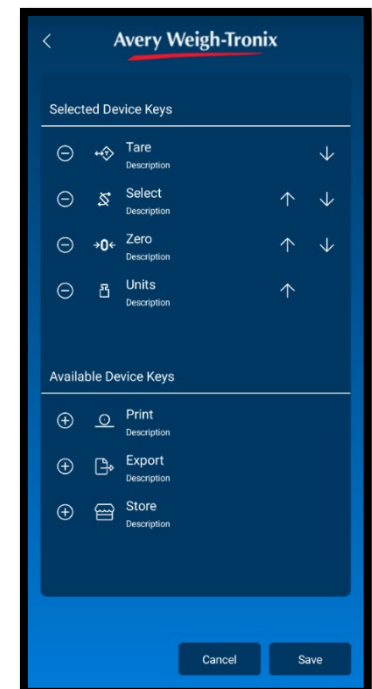

Tap the arrow symbols to change the order (from left to right) the buttons will be in on the Home Screen.

Tap the plus button next to any of the keys under the Available Device Keys to add them to the Home Screen buttons. Tap the minus symbol next to any of the buttons under the Selected Device Keys to remove them from the Home Screen.

6 Web Browser Walkthrough

This section covers the ZM223's remote connectivity using the new Avery Weigh-Tronix web browser page. This web-based application allows operators the ability to run the indicator remotely from any PC or tablet that is connected to the same network that the ZM223 through any search browser. Using the web browser app also provides the user with additional features that cannot be done directly from the ZM223 indicator.

Through the web browser app users can: remotely view live weights, use all Indicator keys, view and change a wide range of app defined weight data fields, change UDF printable text fields that can be used on a print ticket or label, retrieve stored data from the ZM223 flash drive memory, store weight data to the mobile device, and use operator prompts to aid in using the ZM223.

- To navigate between the available webpage screens (Scale, Super, and About), click on the corresponding screen button in the upper right-hand corner of the screen shown below.
- Within the web browser page users can view the active PLU is allowing the operator the ability to view, edit, and adjust UDF fields. Please note that the UDF fields varies depending on the Indicator Application the ZM223 is currently running.
- To use any of the ZM223 Indicator's keys, click on the desired key on the simulated indicator display shown below.
- To edit any of the ZM223 Information Fields click on the "Edit" button to the right of the field that needs to be edited.



Note: IP address used in the web browser must match the indicator's IP address. For example: 192.168.1.23

Subject to the Site Location and the location's requirements for approval a **Not Legal For Trade** Message will display.

Indicator's Info Fields



Note: If the connection is lost and the web browser page will not reconnect, click on the Scale Tab to refresh the screen. It is advised to do this after changing anything in the Supervisor Menu to ensure any new fields that have been turned on have fully activated and displaying on the web browser page.

6.1 Using the Web Browser

Follow the steps below to connect to and operate a ZM223 Indicator from a web browser page.

1. From a new web browser tab (Google Chrome, Microsoft Edge, Safari) type in the IP address of the ZM223 indicator you wish to connect to.



Note: Remember that the ZM223 indicator must be connected to the same network for the web browser page to connect properly.

UDF fields with an **Edit/Pencil icon** next to them are fields that can be changed or edited from the web browser screen.

Designed to provide an easy method to add text data to the transaction data or printed label data

- Currently there are several predefined UDF fields that can be easily turned on from the supervisor menu

UDF 1: Part No **UDF 2: Description** **UDF 3: Loc**

UDF 4: Name **UDF5: Address**

- There are also 10 unnamed UDF fields that can be quickly turned on, edited & used.

UDF 6 UDF 10 UDF 14

UDF 7 UDF 11 UDF 15

UDF 8 UDF 12

UDF 9 UDF 13

6.2 Live Weight

The web browser page will mirror the ZM223 display overlay and constantly show the live weight from the indicator. All ZM223 keys on the web browser, like **TARE**, **SELECT**, **ZERO**, **PRINT**, **UNITS** and **F1** work the same as they do on the indicator.

6.3 Web Browser Page Supervisor Tab

The Supervisor Tab is password protected with the same password as the indicator's Supervisor Menu.

Any of the UDF fields can be modified/renamed from the Web Browser page (see screen capture below).

To gain access to the Supervisor Menu enter the Supervisor password (1793).

From the Supervisor Menu managers can enable, disable, or edit any UDF field.

1. To activate or deactivate a UDF field, click or tap the switch button next to the desired UDF field to toggle it on or off.
2. To edit a UDF field, click or tap on UDF field bar and select the desired UDF value from the popup menu.

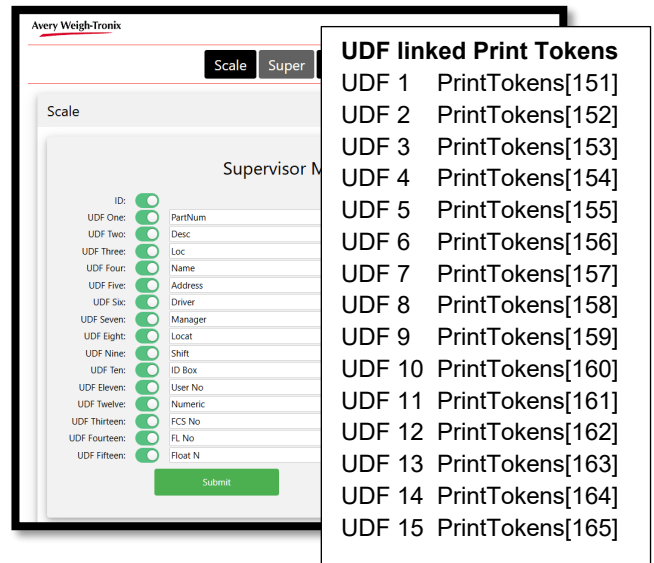

6.4 Mobile and Web Browser Operator Prompts

Unlike the indicator which is limited by the display the web browser screen and the mobile app screen both offer an additional text field area that allows additional operator prompts to be seen and viewed to aid the operator in carrying out the tasks in hand. These prompts will vary depending on the app.

6.5 Viewable Data Fields for Mobile and Web Browser Pages

The Remote Assist Mobile App and web browser pages will show other useful data fields that have been turned on depending on the app.

Available RPN Functions	Application													
	General	Accum	Count	Check			Check Grade	Check by %	Truck In/Out	Batching	P-Hold	Remote Display	In-Motion	AutoLoc
				Simp	Mid	Adv								
Tare Weight	X	X	X		X	X	X	X	X	X	X	X	X	X
ID	X	X	X	X	X	X	X	X	X	X	X	X	X	X
I/O 4-6	X	X						X	X	X	X	X	X	X
Accumulation Channel		X												X
Preact 4 – 6									X					
Gross, Net, Tare								X						
Description			X											
Inbound WT								X						
Outbound WT								X						
PLU			X			X		X						
Grade 1-11							X							
Transaction									X					
Target			X		X	X		X						X
Low			X	X	X	X		X						X
High			X	X	X	X		X						X
Piece Weight			X	X	X	X								
Part Number			X	X	X	X		X						

6.6 UDF Printable Fields

The new web browser view also allows users to view and edit other UDF fields directly from any web browser.

The following UDF fields can be turned on from within the Supervisor menu are:

- Part Number
- Description
- Lot Location
- Name
- Address
- 10 UDF Text Fields

7 Menus

The ZM223's different menu levels allow users to set up different weighing apps, change available settings, and access stored PLUs for the ZM223. All Menu levels available in the ZM223 indicator are accessed through passwords. Users can customize and configure the indicator for their purposes from these menus. The menus are always explained in a sequential manner to cover all information in a logical fashion. Users will most likely never access all the menu items in this manner. Use the provided menu maps to navigate to the menu item(s) that needs to be modified.

The menu levels and their passwords are shown below:

Password	Menu Level	Accessed Menu
111	USER	User, About, Audit
1793	SUPER	Application specific items. See User manual.

7.1 Accessing Menus

Follow these steps to access the menus in the ZM223.

1. With the indicator powered up and in normal operating mode, press and hold **F1** ...
PASS is now displayed, prompting the user to enter the password.
2. Key in the password for the needed menu and press **←** ...
The first item in the top level of the accessed menu is now displayed.
3. Use the navigation keys (**▲**, **▼**, **◀**, or **▶**) to navigate through the menu structure.

7.2 Menu Annunciators

The ZM223's menu structure is made up of menu items, parameters, value entry screens, and lists that the operator can pick from. To help users know where they are in the menu, the bar graph at the top of the display is on while the indicator is in the menus and will change appearance according to the following rules:



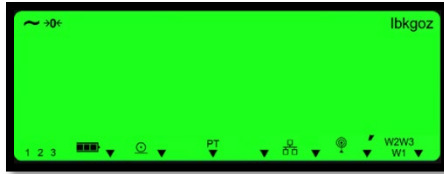

All segments flashing:

This means users are in the menu structure but not in any of the following screens.

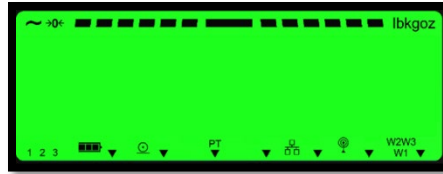

Center flashing/others off:





This refers to a numeric entry screen or the Quick Code prompt screen. Enter in the appropriate Quick Code and press  to accept.

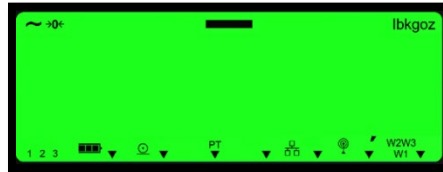

Right flashing/others off:



This refers to a list. Scroll through the choices with the  and  keys and press  to accept.

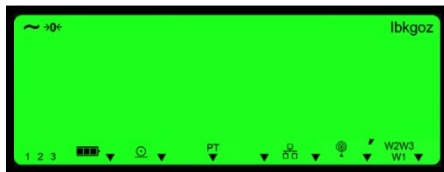

Left flashing/others off:



This refers to a data entry.

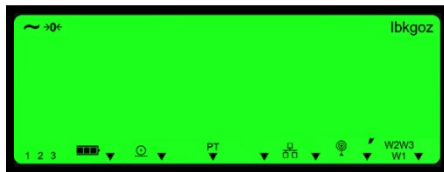

Every alternate segment flashing:



This refers to octet entry for IP, Subnet, or Gateway address.

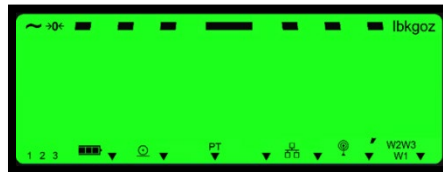
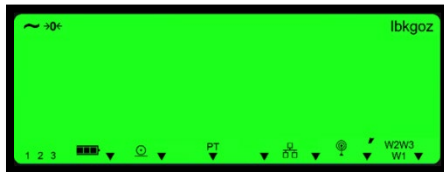

7.3 Exiting Menus

1. Use **F1** to escape and move up one level without accepting the choice or value. From that point, press **▲** repeatedly until ...
SAVe No is now displayed. This means “Do not save changes.”
2. Press **▶** to scroll through the choices: **SAVe no**, **SAvEYES**, and **CANcEI**.
 Press **◀** to accept the displayed choice.
 Select **SAVe No** or **SAvEYES** to have the indicator exit the current menu and returns to normal weighing mode.

OR

Select **CANcEI** for the indicator to remain in the current menu.

7.4 User Menu

The **USER** level contains the User, About, and Audit menus as shown below.

- To access the **USER** level, from normal weighing mode, press and hold the **F1** key.
- Enter password 111 and press the **◀** key.

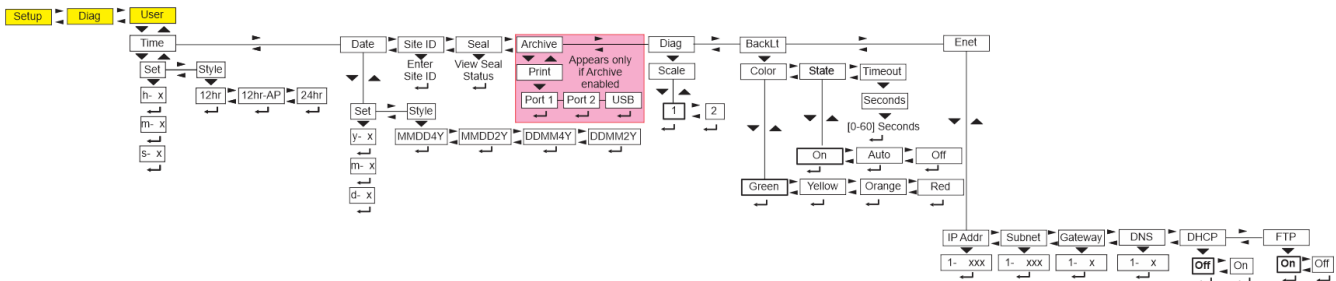

7.4.1 Time

User ↓ Time

Time: This lets users set the clock and choose the style of the time display 12 hr, 12 hr a.m./p.m., or 24 hr. The Time can be used in print formats.



1. Access the User menu and Press **▼** ...

tiME is now displayed. Use this to set the time and clock style.

Set time

Time ↓ Set

Set: Enter in the hour, minute, and second.

2. From **tiME**, press **▼** ...

SEt is now displayed

3. Press **▼** ...



h- x is now displayed, with the **x** flashing. This is a numeric entry screen for the hour value.

4. Key in the hour of the day using military (24 hr) time and press

◀ to accept...

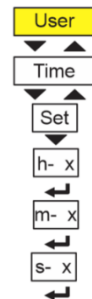
M- x is now displayed, with the **x** flashing. This is a numeric entry screen for the minute value.









- Key in the minute value and press  to accept...
S- x is now displayed, with the x flashing. This is a numeric entry screen for the second value.
- Key in the seconds value and press  to accept...
SEt is now displayed.

Style

Time ↓ Set → Style

Style: Choose the style of the time display (12 hr, 12 hr a.m./p.m., or 24 hr military)

- From **SEt** press  ...
StYLE is now displayed.
- Press  ...
12hr is now displayed.
- Press  or  to scroll through the choices. Press  when your choice is now displayed ...
StYLE is now displayed.
- Press  ...
tiME is now displayed.

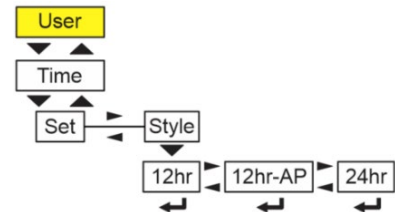

7.4.2 Date

User ↓ Time → Date

Date: This allows users/technicians set the year, month, day, and the style of the displayed date. The Date can be used in print formats.



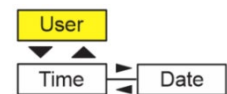

- From **tiME**, press  ...
dAtE is now displayed.





Set date

Date ↓ Set

Set: Enter in the date's year, month, and day.

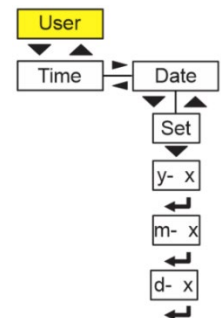
- From **dAtE** press  ...
SEt is now displayed.
- Press  ...
y- x is now displayed, with the x flashing. This is a numeric entry screen for the year value.
- Key in the year and press  to accept ...
M- x is now displayed, with the x flashing. This is a numeric entry screen for the month.
- Key in the month value and press  to accept ...
d- x is now displayed, with the x flashing. This is a numeric entry screen for the day value.









- Key in the day value and press  to accept ...
SEt is now displayed.

Style

Date ↓ Set → Style

Style: Choose the style for how the date display (MMDD2Y, MMDD4Y, DDMM2Y, and DDMM4Y)







- Press  ...
StYLE is now displayed. Choices are **MMDD2Y**, **MMDD4Y**, **DDMM2Y**, and **DDMM4Y**.
- Press  ...
MMDD4Y is now displayed.
- Press  or  to scroll through the choices. Press  when your choice is now displayed ...
StYLE is now displayed.
- Press  ...
dAtE is now displayed.

7.4.3 Site ID

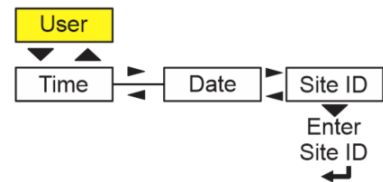
User ↓ Time → Date → Site ID

Site ID: This allows users/technicians to enter a Site ID. Use the alphanumeric keys to enter a Site ID (maximum 7 digits). Site ID can be used in a print format.



- From **dAtE**, press  item...
SitE id is now displayed.
- Press  ...
A string entry screen is now displayed.
- Key in the site ID number on the numeric keypad and press  to accept ...
SitEid is now displayed.

7.4.4 Seal

User ↓ Time → Date → Site ID → Seal

Seal: This allows users/technicians to view the seal status of the physical seal jumper inside the indicator. If the unit is sealed, no changes can be made to the configuration of the indicator. For more information, see the note below.

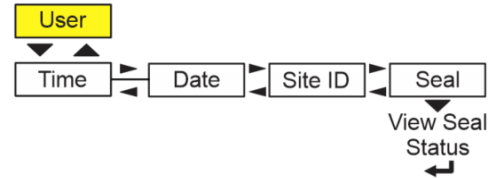

1. From **SitE id**, press **▶** ...

SEAL is now displayed.

2. Press **▼** ...

Either **no SEAL** or **SEALd** is now displayed. This is the status of the physical seal jumper inside the indicator. If the unit is sealed, no changes can be made to the configuration of the indicator.

3. Press **F1** to return to the **SEAL** display

7.4.5 Archive or Alibi Memory

User ↓ Time → Date → Site ID → Seal → Archive

Alibi Memory: Normally used for legal for trade traceability, this provides a consecutive number for each transaction which is stored in three different locations within the indicator's internal memory (can hold around 5000 transactions). This item appears only if configured in the ADMIN menu.

USB drive: When a USB drive is connected it can hold around 100,000 additional transactions. Printing to USB requires that a USB flash drive is connected to the indicator host USB. Printing to USB will create a folder on the flash drive and a comma separated file with the data.

Micro SD memory: When a Micro SD Card is connected it can hold around 100,000 additional transactions. Printing to a Micro SD Card requires that the Micro SD Card. Printing to USB will create a folder on the flash drive and a comma separated file with the data.

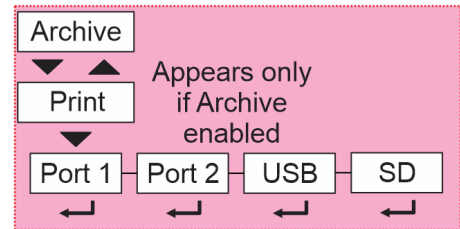

7.4.6 Diagnostics

User ↓ Time → Date → Site ID → Seal → Archive → Diagnostics

Diagnostics: This allows users to view and change basic diagnostics settings for the indicator and any connected scale bases.

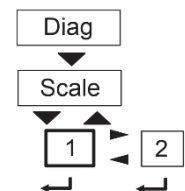

7.4.7 Backlight

User ↓ Time → Date → Site ID → Seal → Archive → Diagnostics → Backlight

BackLt: This allows users to set the primary back light color for the indicator. Some of the Indicator apps will override the primary back light color. In these apps the back light control setting can be modified from within the Supervisor Menu.

Color: This allows the user to set the color of the primary backlight (Green, Yellow, Orange, or Red). The “None” option turns off the backlight putting the indicator in Outdoor mode.

State: This allows the user to turn the backlight on, off, or to automatically trigger when the indicator is interacted with.

Timeout: This allows the user to set the length of time before the backlight turns off.

Users can adjust the backlight brightness and contrast holding the **F1** (brightness) or **UNITS** (contrast) key and use ▲ and ▼ to adjust the settings. The brightness and contrast are saved automatically and will be applied after a reboot.

13. From **diAg**, press ► ...

BackLt is now displayed.

14. Press ▼ ...

Color is now displayed. Press ▼ again and use ◀ or ▶ cycle through the available backlight colors.

15. Press ⏪ to choose the displayed color option...

Color is now displayed

16. From **Color** press ► ...

State is now displayed. Press ▼ again and use ◀ or ▶ to cycle through the available options.

17. From **State** press ► ...

Timeout is now displayed. Press ▼ again to enter in the timeout limit [between 0-60 seconds].

18. Press ⏪ to accept the displayed value...

TiMout is now displayed.

19. Press ▲ ...

diSPIAy is now displayed

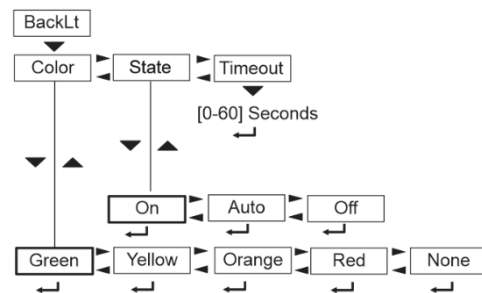

7.4.8 Ethernet

User ↓ Time → Date → Site ID → Seal → Archive (when enabled) → Diagnostics → Backlight → Ethernet

Enet: Stands for Ethernet. Use this to view and edit the network addresses. If the indicator is connected to an Ethernet network, the values displayed will be the current assigned addresses.

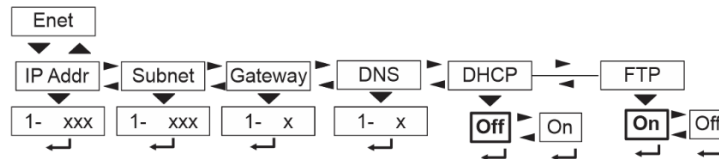

- From **bAckIt**, press ...
EnEt is now displayed. Use this item to view the values for the IP, Subnet, Gateway and MAC addresses.

IP

Enet ↓ IP Addr

IP: Use this to view and edit the Indicator's IP address. To edit any part of the address, navigate to the octet that needs to be edited and key in the desired changes.

- From **EnEt** press ...
iP Addr is now displayed. Use this item to view and edit the four-part IP address.
- Press ...
1-xxx is now displayed. This is the first octet of the IP address
- Press ...
2-xxx is now displayed. This is the second octet of the IP address.
- Press ...
3-xxx is now displayed. This is the third octet of the IP address.
- Press ...
4-xxx is now displayed. This is the fourth octet of the IP address.
- Press ...
iP Addr is now displayed.

Subnet

Enet ↓ IP Addr → SubNET

Subnet: Use this to view and edit the Subnet address. To edit any part of the address, navigate to the octet that needs to be edited and key in the desired changes.

- From **iP Addr** press ...
SubNET is now displayed.
- Press ...
1-xxx is now displayed. This is the first octet of the Subnet address.
- Press ...
2-xxx is now displayed. This is the second octet of the Subnet address.

11. Press  ...

3-xxx is now displayed. This is the third octet of the Subnet address.

12. Press  ...

4-xxx is now displayed. This is the fourth octet of the Subnet address.

13. Press  ...

SubNEt is now displayed

Gateway

Enet ↓ IP Addr → Gateway

Gateway: Use this to view the Gateway address. To edit any part of the address, navigate to the octet that needs to be edited and key in the desired changes.

14. From **SubNEt** press  ...

GAtEwAy is now displayed.

15. Press  ...

1-xxx is now displayed. This is the first octet of the Gateway address.

16. Press  ...

2-xxx is now displayed. This is the second octet of the Gateway address.

17. Press  ...

3-xxx is now displayed. This is the third octet of the Gateway address.

18. Press  ...

4-xxx is now displayed. This is the fourth octet of the Gateway address.

19. Press  ...

GAtEwAy is now displayed

DNS

Enet ↓ IP Addr → DNS

DNS: Domain Name System translates human-readable domain names (like www.example.com) into machine-readable IP addresses (like 192.168.1.1). Use this to view the DNS address. To edit any part of the address, navigate to the octet that needs to be edited and key in the desired changes.

20. From **GAtEwAy** press  ...

dNS is now displayed.

21. Press  ...

1-xxx is now displayed. This is the first octet of the Gateway address.

22. Press  ...

2-xxx is now displayed. This is the second octet of the Gateway address.

23. Press  ...

3-xxx is now displayed. This is the third octet of the Gateway address.

24. Press  ...





4-xxx is now displayed. This is the fourth octet of the Gateway address.

25. Press  ...
dNS is now displayed.

DHCP

Enet ↓ IP Addr → DNS → DHCP





DHCP: Dynamic Host Configuration Protocol assigns an IP Address to a device. DHCP is the opposite is a Static IP Address. Static IPs are industry standard but there are some circumstances where DHCP is used.

26. From **dNS** press  ...
dHCP is now displayed.
27. Press  ...
OFF is now displayed
28. To enable DHCP, press  ...
ON is now displayed
29. Press  ...
dHCP is now displayed.

FTP

Enet ↓ IP Addr → DNS → DHCP → FTP

FTP: File Transfer Protocol is a standard network protocol used to transfer files between a client and server on a computer network.

30. From **dHCP** press  ...
FTP is now displayed.
31. Press  ...
ON is now displayed
32. To disable FTP, press  ...
OFF is now displayed
33. Press  ...
dHCP is now displayed.

9. Press ▲ to return to the **boot** item.
10. The above steps also allow users to view the PN and Versions for both Firmware and App fields.

7.5.2 Serial

About ↓ Boot → Firmware → Application → Serial

Serial: This allows users to view the Serial Number of the indicator. The number is now displayed in two parts. Press ◀ or ▶ to toggle the display between the first and second parts of the serial number. The Serial Number should match the serial number that is printed on the indicator ID tag and is also included in the printed calibration report.

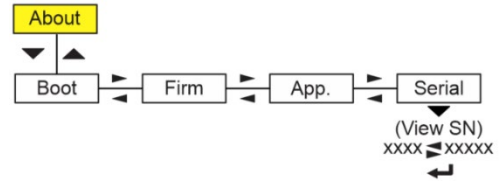

1. With **APP** displayed, press ▶ to move to the next item in this level ...
SErIAL is now displayed.

2. Press ▼ ...
The first part of the indicator's serial number is now displayed.
3. Press ◀ or ▶ to toggle the display between the first and second parts of the serial number.
4. Press ◀ to return to the **SErIAL** display.

7.5.3 Option

About ↓ Boot → Firmware → Application → Serial → Option

Option: This allows users to view the description and version of an installed option card.

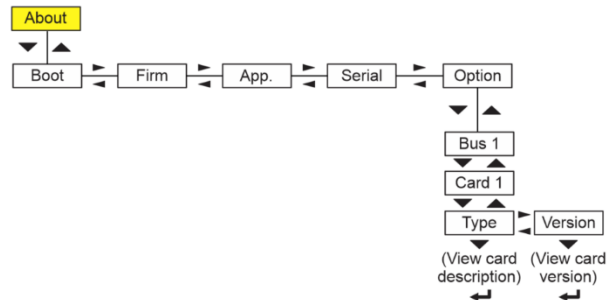

Bus 1: Refers to Bus 1, where the option card is attached. There is only 1 Bus in the ZM223.

Card 1: Refers to the installed Option Card. There is only 1 Card in the ZM223.

1. From **SErIAL**, press ▶ ...
oPtion is now displayed. Use this to view the version and type of installed option card.
2. Press ▼ ...
buS 1 is now displayed.
3. Press ▼ ...
CARD 1 is now displayed.
4. Press ▼ ...
TyPE is now displayed.
5. Press ▼ to see the type of the installed option card ...
The type of card is now displayed. If there is no installed option card, NoNE is now displayed.

6. Press **↵** ...
TypE is now displayed.
7. Press **▶** ...
VERsioN is now displayed.
8. Press **▼** to see the version of the installed option card...
The version is now displayed. If there is no installed option card, **NoNE** is now displayed.
9. Press **↵** ...
VERsioN is now displayed.
10. Press **▲** 3 times ...
OPTioN is now displayed.

7.5.4 Enet

About ↓ Boot → Firmware → Application → Serial → Option → Enet

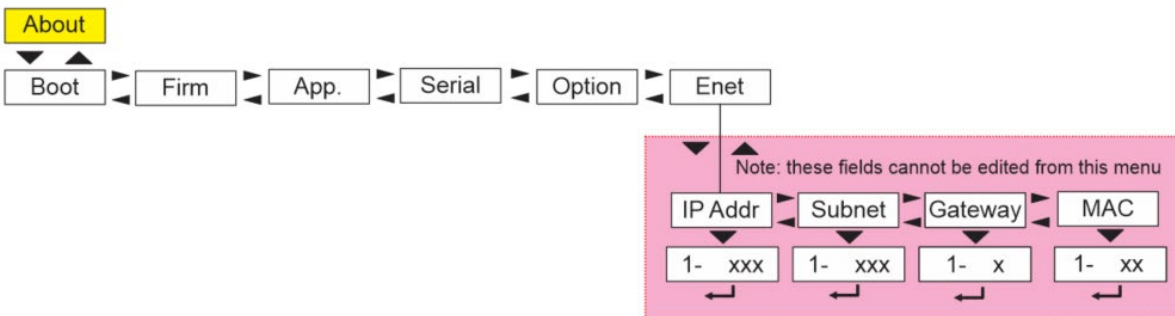

Enet: Stands for Ethernet. Use this to view the network addresses. The network address may be changed under the Admin menu when it comes to internet security. If the indicator is connected to an Ethernet network, the values displayed will be the current assigned addresses.



1. From **oPtion**, press **▶** ...
EnEt is now displayed. Use this item to view the values for the IP, Subnet, Gateway and MAC addresses.

IP

Enet ↓ IP Addr

IP: Use this to view the IP address.







2. From **EnEt** press **▼** ...
iP Addr is now displayed. Use this item to view the four-part IP address.
3. Press **▼** ...
1-xxx is now displayed. This is the first octet of the IP address
4. Press **↵** ...
2-xxx is now displayed. This is the second octet of the IP address.
5. Press **↵** ...
3-xxx is now displayed. This is the third octet of the IP address.

6. Press  ...
4-xxx is now displayed. This is the fourth octet of the IP address.
7. Press  ...
iP Addr is now displayed.

Subnet

Enet ↓ IP Addr → Subnet







Subnet: Use this to view the Subnet address.

8. From **iP Addr** press  ...
SubNEt is now displayed.
9. Press  ...
1-xxx is now displayed. This is the first octet of the Subnet address
10. Press  ...
2-xxx is now displayed. This is the second octet of the Subnet address.
11. Press  ...
3-xxx is now displayed. This is the third octet of the Subnet address.
12. Press  ...
4-xxx is now displayed. This is the fourth octet of the Subnet address.
13. Press  ...
SubNEt is now displayed.
14. When finished, press  to return to the Enet menu item.

Gateway

Enet ↓ IP Addr → Subnet → Gateway

Gateway: Use this to view the Gateway address.

15. From **SubNEt** press  ...
GAtEwAy is now displayed.
16. Press  ...
1-xxx is now displayed. This is the first octet of the Gateway address
17. Press  ...
2-xxx is now displayed. This is the second octet of the Gateway address.
18. Press  ...
3-xxx is now displayed. This is the third octet of the Gateway address.
19. Press  ...
4-xxx is now displayed. This is the fourth octet of the Gateway address.
20. Press  ...
GAtEwAy is now displayed.

21. When you are finished, press ▲ to return to the **Enet** menu item.

MAC

Enet ↓ **IP Addr** → **Subnet** → **Gateway** → **MAC**

MAC: Use this to view the MAC address.

22. From **GAtEwAy** press ► ...

MAC is now displayed.

23. Press ▼ ...

1-xxx is now displayed. This is the first octet of the MAC address

24. Press ↵ ...

2-xxx is now displayed. This is the second octet of the MAC address.

25. Press ↵ ...

3-xxx is now displayed. This is the third octet of the MAC address.

26. Press ↵ ...

4-xxx is now displayed. This is the fourth octet of the MAC address.

27. Press ↵ ...

5-xxx is now displayed. This is the fifth octet of the MAC address.

28. Press ↵ ...

6-xxx is now displayed. This is the sixth octet of the MAC address.

29. Press ↵ ...

MAC is now displayed.

30. When you are finished, press ▲ to return to the **Enet** menu item.



Note: The IP, Subnet, and Gateway addresses are a series of octets with each octet having a value between 0 and 255. The MAC address is a series of six double digit values: 1 XX, 2 XX, 3 XX, etc.

7.5.5 Download

About ↓ **Boot** → **Firmware** → **Application** → **Serial** → **Option** → **Enet** → **Dload**



The Download menus are used for security and licensing purposes. To upload a configuration file, the license number of the Configurator (Ztools) software must match one of the license numbers in the indicator. Contact AWTX Technical Support for assistance.

This allows someone to check what Ztools license was used to create the configuration file found inside the indicator along with which Ztools license this was used to download this file configuration into the scale.

To upload a Ztools configuration file from the scale, the Ztools license used to upload the file from the scale must match with the license that created it. If it does not match, the file will not be allowed to upload. If the license number of your Configuration Software application does not match either the SSerial or DSerial numbers you will be unable to

upload the existing configuration file from the indicator. Contact AWTX Technical Support for assistance

Dload: Stands for download. Use this to view the **Sserial** and **Dserial** menus

1. From **EnEt** press **▶** ...
dLoAd is now displayed. This stands for download.

Sserial

Dload ↓ Sserial

Sserial: This allows users to view the license number that created the configuration file.

2. From **dLoAd** press **▼** ...
SSEriAL is now displayed.

3. Press **▼** ...

The 1st third of the serial number of the creating application of the configuration file is now displayed.

4. Press **▶** to show the 2nd third.
5. Press **▶** to show the final third of the serial number.
6. Press **F1** ...

SSEriAL is now displayed.

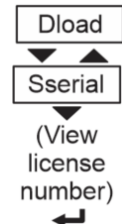

Dserial

Dload ↓ Sserial → Dserial

Dserial: This allows users to view the license number that downloaded the configuration file.

7. From **SSEriAL** press **▶** ...
dSEriAL is now displayed.

8. Press **▼** ...

The 1st third of the serial number of the downloading application of the configuration file was downloaded to, is now displayed.

9. Press **▶** to show the 2nd third.
10. Press **▶** to show the final third of the serial number.
11. Press **F1**...

dSEriAL is now displayed.

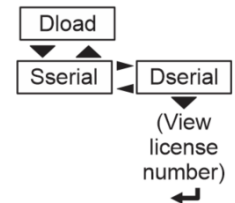

DNAME

Dload ↓ Sserial → Dserial → DNAME

DNAME: this allows users to view the licence name.

12. From **DSEriAL** press **▶** ...
DNAME is now displayed.

13. Press **▼** ...

The 1st third of the license name of the downloading application of the configuration file was downloaded to, is now displayed.

14. Press **▶** to show the 2nd third.

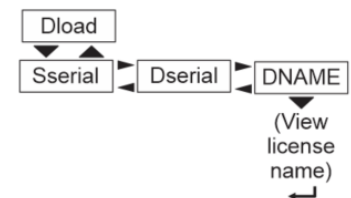

15. Press **▶** to show the final third of the serial number.
16. Press **F1**...

DNAME is now displayed.

17. Press **▲** twice ...

About is now displayed.

7.5.6 BSQ

About ↓ Boot → Firmware → Application → Serial → Option → Enet → Dload → BSQ



Scale 1 or Scale 2

BSQ ↓ Scale 1 → Scale 2

Scale 1 or 2: This allows users to select which of the two Quartzell™ bases' information they want to view.

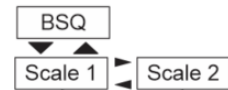

1. From **BSQ**, press **▼** ...
Scale 1 is now displayed
2. Press **▶** to cycle between **Scale 1** and **Scale 2**,

SW Part

BSQ ↓ Scale 1 ↓ SW Part

SW Part: This allows users to view the firmware PN for the Quartzell™ that is connected.

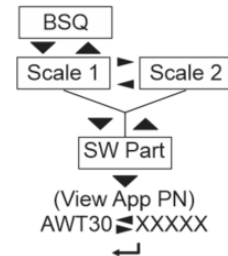

3. From **Scale 1** or **Scale 2**, press **▼** ...
SW Part is now displayed
4. Press **▼** ...
AWT30 is now displayed
5. Use **◀** or **▶** to cycle through the whole PN

Version

BSQ ↓ Scale 1 ↓ SW Part → Version

Version: This allows users to view the firmware version for the Quartzell™ that is connected.

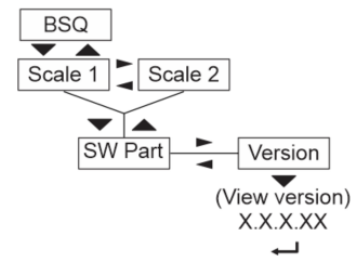

6. From **SW Part**, press **▶** ...
VERsion is now displayed
7. Press **▼** ...
The version number is now displayed.
8. Use **◀** or **▶** to cycle through the whole version number.

Cur Ser

BSQ ↓ Scale 1 ↓ SW Part → Version → Cur Ser

Current Quartzell™ Serial Number: This allows users to view the Serial Number of the Quartzell™ that is connected.

- From **VERsion**, press **▶** ...

Cur Ser is now displayed

- Press **▼** ...

The serial number is now displayed.

- Use **◀** or **▶** to cycle through the whole serial number

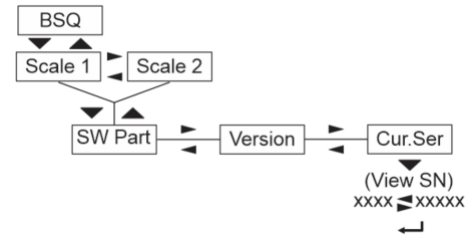

Cal Ser

BSQ ↓ Scale 1 ↓ SW Part → Version → Cur Ser → Cal Ser

Cal Ser: This allows users to view the Serial Number of the Quartzell™ that was connected when last calibrated.

- From **Cur Ser**, press **▶** ...

Cal Ser is now displayed

- Press **▼** ...

The serial number is now displayed.

- Use **◀** or **▶** to cycle through the whole serial number

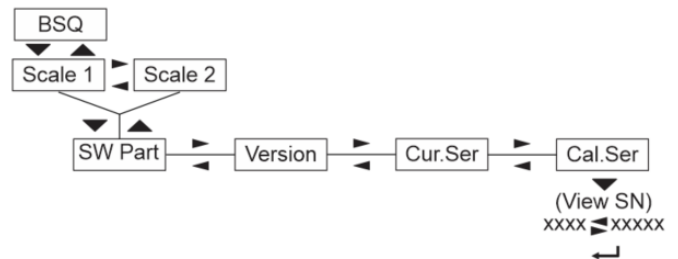

7.5.7 Site

About ↓ Boot → Firmware → Application → Serial → Option → Enet → Dload → BSQ → Site

Site: This allows users to choose the geographical location of the indication between USA, Great Britan, Canada, Europe, China, India, and Sri Lanka. When using the 111 User Menu, you can only view the site location and not change it.

- From **BSQ** press **▶** ...

Site is now displayed.

- Press **▼** ...

- Use **◀** or **▶** to cycle through all the Site options.



7.5.8 Main Board Hardware

About ↓ Boot → Firmware → Application → Serial → Option → Enet → Dload → BSQ → Site → HW Rev

HW Rev: This allows users to identify the main PC Board build level without opening the back of the indicator.

- From **Site** press **▶** ...

HW REv is now displayed.

- Press **▼** ...

The PC Board build level number is now displayed

- Press Press **◀** ...

HW REv is now displayed.

7.5.9 bLE MAC

About ↓ Boot → Firmware → Application → Serial → Option → Enet → Dload → BSQ → Site → HW Rev → bIE MAC

bIE MAC: This allows users to view the Indicator's Bluetooth Low Energy unit's MAC address.

1. From **HW REv** press ► ...

bLE MAC is now displayed.

2. Press ▼ ...

The 1st half of the bLE MAC address is now displayed.

3. Press ► to show the 2nd half of the bLE MAC address.

4. Press **F1**...

bIE MAC is now displayed.

5. Press ▲ ...

About is now displayed.

7.6 Audit Menu

Use the Audit menu to display audit counters for configuration and calibration and to print the information.

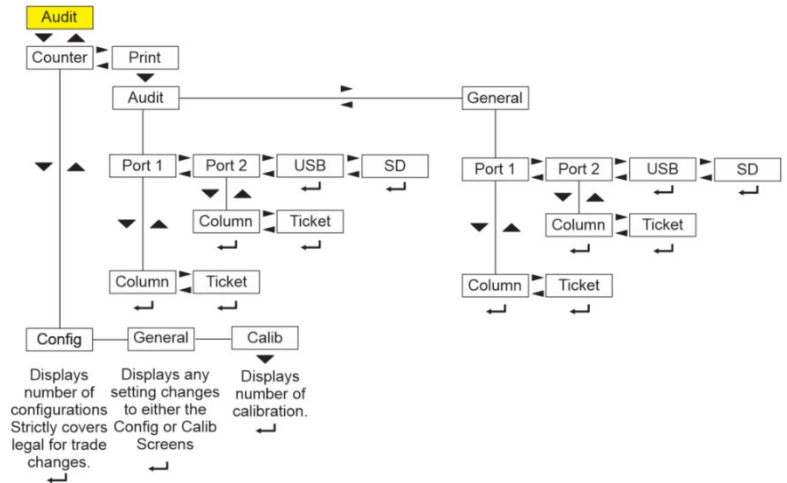

7.6.1 Counter

Audit ↓ Counter

Counter: This allows users to view the number of times the indicator has been calibrated or has had its configuration changed. The Counter has 3 main counter areas that can track changes made to the indicator.



1. Access the Audit menu and press ▼ ...
countEr is now displayed.

Configuration

Counter ↓ Config

Config: Shows the number of times a change to the configuration parameters has been made. This counter only controls metrology-based configuration settings.

2. From **countEr** Press ▼ ...
conFig is now displayed.
3. Press ▼ again ...
A number appears showing how many times the indicator has been configured.
4. Press ← ...
conFig is now displayed.

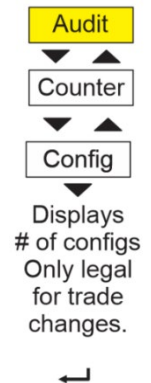

General

Counter ↓ Config → General

General: Shows the number of times the indicator has had a non-metrology-based configuration change done to it. These changes cover functions and features not controlled by any legal for trade setting such as display backlight color, IP addresses and other.

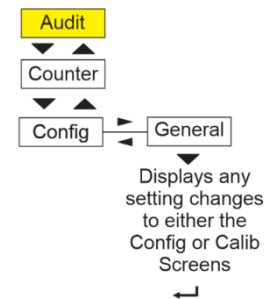

5. From **conFig** Press **▶** ...

General is now displayed.

6. Press **▼** again ...

Any changes to either the conFig or cALib menus will now display.

7. Press **←** ...

General is now displayed.

Calibration

Counter ↓ Config → General → Calib

Calib: Shows the number of times the scale has been calibrated.

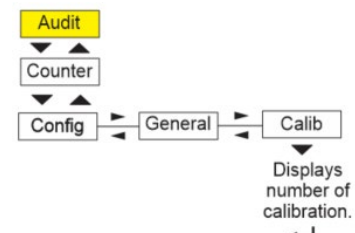

8. From **General** press **▶** to move to the next item in this level ...

cALib is now displayed.

9. Press **▼** ...

A number appears showing how many times the indicator has been calibrated.

10. Press **←** ...

cALib is now displayed.

11. Press **▲** ...

countEr is now displayed.

7.6.2 Print

Audit ↓ Counter → Print

Print: This allows users to choose which available connection port to print Audit or General Reports from Port1, Port 2, USB, or SD.

Audit: Audit reports log only changes to legal for trade settings.

General: General reports show all changes to settings, including legal for trade.

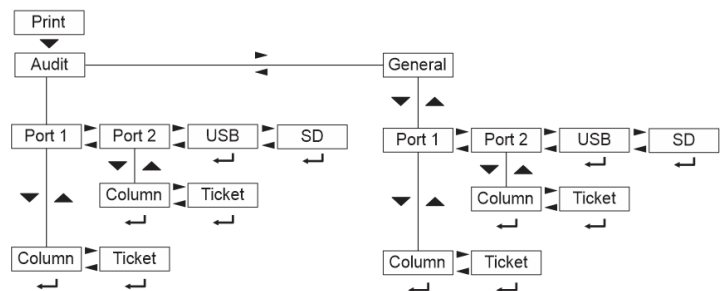

1. From **countEr** press **▶** ...

PriNt is now displayed.

Port 1/Port 2/USB/SD

Print ↓ Port 1 → Port 2 → USB → SD

Print: This allows users to print off Audit Counters or General Counter information.

Port 1: Under Port 1 choose to print to a column or ticket printer.

Port 2: Under Port 2 choose to print to a column or ticket printer.

USB: Printing to USB requires that a USB flash drive is connected to the indicator host USB. Printing to USB will create a folder on the flash drive and a comma separated file with the data. Printing to USB requires that a USB flash drive is connected to the indicator host USB. Printing to USB will create a folder on the flash drive and a comma separated file with the data.

SD: Printing to SD requires that the Micro SD Card is connected to the indicator. Printing to SD will create a folder on the card and a comma separated file with the data.

2. From **PrINt** press ▼ ...

Audit is now displayed. Use ◀ or ▶ to choose between Audit and General. The steps are the same for both Audit and General.

3. Press ▼ ...

Port 1 is now displayed. This is the first of four choices: **Port 1**, **Port 2**, **USb** and **Sd**. Use these to select which port to print the Audit report through.

4. Press ◀ or ▶ to scroll through the choices and press ↵ to select an option ...

Audit is now displayed.

8 Supervisor Menus

The Supervisor Menus allow technicians and supervisors to setup and change the functions of any of the configurable indicator applications that come with the ZM223.

Wherever there is an option to print information in the any of the Supervisor's Menus, the information will print out of Port 1, Port 2, or to USB, whichever is configured.

Access the Supervisor Menu using the password 1793. Please note that the Supervisor menu changes based on the active application running and that the menus are always explained sequentially. Technicians can navigate to the area of the menu that needs to be changed by using the navigation keys.

List of what is under the Supervisor Menu:

- **Setpoint:** This allows users to set setpoints and output values (starting on [page Error! Bookmark not defined.](#)).
- **Tare:** This allows users to set up and store Preset Tare values if enabled in the Admin Menu ([page 136](#)).
- **App Related Configuration:** Each app has different configurable settings.
 - Accumulation App ([page 139](#))
 - Truck In & Out App ([page 143](#))
 - Counting App ([page 145](#))
 - Checkweighing Simple App ([page 159](#))
 - Checkweighing Mid App ([page 163](#))
 - Checkweighing Adv App ([page 170](#))
 - Check Percentage App Supervisor Menu ([page 177](#))
 - Batching App Supervisor Menu ([page 183](#))
 - Remote Display Supervisor Menu ([page 188](#))
 - In-Motion App Supervisor Menu ([page 195](#))
 - Grading App Supervisor Menu ([page 199](#))
 - AutoLoc App Supervisor Menu ([page AutoLoc Setup200](#))
- **PLU:** This is where PLUs are set up for apps that use an internal database.
- **Battery:** This controls some power saving functions when the indicator is connected to a DC power source ([page 200](#)).
- **RPN:** This allows users to set secondary key functions ([page Error! Bookmark not defined.](#)).
- **Mobile:** This enables what User Defined Fields and scale fields that are available when using the Remote Assist Mobile App or web browser pages ([page 207](#)).
- **App Info:** This shows users the app and software revisions currently running on this indicator ([page 208](#)).

8.1.1 Setpoints for the General – Accumulation – Truck In/Out Applications

Super ↓ Setpoint

Setpoints: Setpoints are specific weight values that trigger outputs when reached. The triggered outputs can control relays connected to valves, lights, other machinery, etc. Setpoint outputs are configured in the Setpoint Menu.

In other applications like Counting, Checkweighing, Grading, and Batching, the app will control the inputs in the same way, but the outputs will be controlled differently. Please refer to the “Reverent Supervisors” app menu section for more details.

When using an external battery like the ZQbat to run the indicator, setpoint output #3 can be configured for shutting down the battery for power saving.

A setpoint value can be entered ranging from +/- scale capacity. For the negative numeric entry process. Turn off or disable any setpoints you are not using.

1. Access the Supervisor menu and press **SuPEr**, press ▼ ...

SETPNT is now displayed. Use this to:

- Set the mode of outputs operation
- Enter the output values
- Set backlight colors for outputs
- Select function for the inputs
- Print the setpoint settings
- Reset all setpoint settings to factory defaults.

Inputs I/O 1 – I/O 3

Setpoint ↓ Edit ↓ I/O 1-3 (Inputs)

Inputs: are electrical inputs that can trigger a required input like to Zero the scale, to Tare off the scale to start or stop a process. In most ZM223 apps the 1st 3 set points I/O as programed to be just inputs.

2. Press ▼ ...

Edit is now displayed.

3. Press ▼ ...

I/O1 is now displayed. This stands for input 1. Use this to assign a function to input 1 when an external switch is tripped.

4. Press ▼ ...

The current choice is now displayed.

5. Use ◀ or ▶ to scroll through the choices and when your choice is displayed, press ↵ to accept ...

I/O1 is now displayed.

6. Press ▶ ...

I/O2 is now displayed.

7. Repeat steps 3 through 5 for **I/O2** and **I/O3**.

8. Press ▲ when finished ...

Edit is now displayed.

Outputs I/O 4 – I/O 6

Setpoint ↓ Edit ↓ I/O 1-3 → I/O 4-6 (Outputs)



Note: All outputs are deactivated by default. To activate an Output, navigate to the Mode x area for the Output and select how it will operate.

Outputs: are used to turn on or off relays to control external processes like stack lights, alarms, hopper, valve gates, actuators, and more. The ZM223 indicator apps are mostly programmed to use the last 3 Set points, I/O4, I/O5, and I/O6 as outputs. setting up the outputs is explained below.

There are 3 steps to setting an Output:

1. Set the mode of how the output with turn on and off in.
2. Set the output on-trigger point or the off-trigger point values.
3. Determine if the backlight will follow the Output on trigger point.

EditX: This determines the value that triggers the output. Whether a weight must be above or below the set value depends on the Mode.

ModeX: This determines when the output triggers. For example, the Act Above mode means the output is active when a weight is above the set value. Likewise, the Act Below means the output is active when the weight is below the set value.

BacklightX: This is used to tie the backlight to the Output On trigger. Please note, the backlight only activates on the Output On trigger and will not turn off with the Output Off trigger.

Due to this, if only one Output is used and a backlight color is linked to it, a second Output will be needed to change the backlight back to the original color.

9. From I/O 3, press ► ...

I/O 4 is now displayed. Technicians can access I/O 4 by pressing the ▼ key. The following instructions apply to any of these three outputs.

10. Press ▼ ...

EDITX is now displayed. X being the number of the output.

11. Press ► ...

MOdEX is now displayed. This menu item sets the function of the output.

Mode selection must be made before entering the Out value.

12. Press ▼ ...

The current Mode setting for the selected Output is now displayed. The Mode settings are listed below:

diSAbIE (default): The output remains off.

ACT-Abv: The output turns on when the weight is above the set weight value and turns off when the weight returns to below.

ACT-bEI: The output turns on when the weight is below the set weight value and turns off when the weight returns to above.

ACT-IN: The output turns on when the weight is inside of the low and high set values.

ACT-OUT: The output turns on when the weight is outside of the low and high set values.

ACTAbv2: The output turns on immediately when the weight is above the configured value but when it is below the value it does not turn on until there is no motion.

ACTbEI2: The output turns off immediately when the weight is below the configured value, forbut when it is above the value it does not turn on until there is no motion.

13. Use ◀ or ▶ to scroll through the Setpoint Modes (**ACT-Abv**, **ACT-bEI**, **ACT-IN**, **ACT-OUT**, **ACTAbv2**, **ACTbEI2**)

For **ACT-Abv** or **ACT-bEL**, set the Edit X value to the required trigger weight point.

14. From **ACT-Abv** or **ACT-bEL**, press ⏪ ...

MOdEx is displayed

15. Press ◀ ...

EdITX is now displayed

16. Press ▼ ...

A numeric entry screen is displayed. Key in the desired above or below output value.

17. Press ⏪ to accept the value...

EdITX is now displayed.

For **ACT-IN**, **ACT-OUT**, **ACTAbv2** or **ACTbEI2**, **I/O XLO** and **I/O XHI** are displayed under **EdITX**. Set the Edit X high and low limits to the required trigger points.

18. From **ACT-IN**, **ACT-OUT**, **ACTAbv2** or **ACTbEI2**, **I/O XLO** and **I/O XHI**, press ⏪ ...

MOdEx is displayed

19. Press ◀ ...

EdITX is now displayed

20. Press ▼ ...

I/O XLO is now displayed

21. Press ▼ ...

A numeric entry screen is displayed. Key in the desired above or below output value.

22. Press ⏪ to accept the value...

I/O XLO is now displayed

23. Press ▶ ...

I/O HI is now displayed.

24. Press ▼ ...

A numeric entry screen is displayed. Key in the desired above or below output value.

25. Press ⏪ to accept the value...

I/O HI is now displayed.

26. Press the ▲ key until **I/O x** is now displayed.
27. Repeat steps 9 through 26 for **I/O 5** and **I/O 6**.

Linking Backlights to Outputs

Setpoint ↓ **Edit** ↓ **I/O 1-3** → **I/O 4-6** ↓ **Edit X** → **Mode X** → **Backlight X**

Backlight: This determines what color the backlight is when the specific output is triggered. (Default is green) When linking a backlight color to the I/O mode, this only controls the backlight color turning on. It will not turn off the backlight when the Output turns off. To turn the backlight back to the original color, a 2nd output setting is required to trigger the backlight color to change back.

28. From **MOdEX**, press ► ...
bKLT X is now displayed.
29. Press ▼ ...
The default primary backlight color is now displayed (**GrEEN, yELlow, OrANgE, REd, NoNE**)
30. Use ◀ or ▶ to scroll through the backlight colors and press ↵ to make a selection ...
bKLT X is now displayed.

For example: If the line requires the output to turn the backlight from red to green once a specific weight is reached **I/O4** would have to be set to:

Mode 4: Act in
Edit 4: lo 1 lb
hi 10 lb
BackLt 4: Green

To have the backlight return to red, **I/O5** would have to be set to:

Mode 5: Act Above
Edit 5: 10 lb
BackLt 5: Red

Print

Setpoint ↓ **Edit** → **Print**

Print: this allows users to choose which available connection port Print Commands are sent to: Port1, Port 2, or USB. A USB drive must be plugged into the USB port for any data to be Printed/Saved.

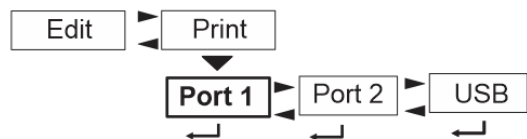

31. Press ► ...
PrINt is now displayed. Use this to print the settings under **SETPNT**.
32. Press ▼ ...
Port 1 is now displayed.
33. Press **F1** to abort the print process or press ► to scroll to the desired port and press ↵ to print the information ...
PrINt is displayed after either action.

Reset

Setpoint ↓ Edit → Print → Reset

Reset: Use this to reset the settings under **Edit** to factory defaults.

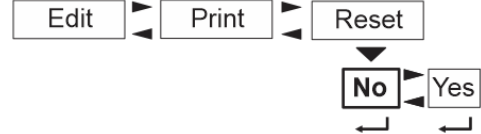

34. Press **▶** ...

RESEt is now displayed.

35. Press **▼** ...

No is now displayed.

36. Press **F1** to abort the reset or press **▶** ...

YES is now displayed.

37. Press **←** to reset the settings to factory defaults ...

RESEt is now displayed.

38. Press **▲** ...

SETPNT is now displayed.

8.1.2 Setpoints for the Checkweighing Apps

Super ↓ Setpoint

In all checkweighing apps and the counting app the only available setpoint sections are I/O 1 to 3 inputs which are covered below. All outputs control the Under, Over, and Accept weight bands set in the Supervisor Menu.

8.1.2.1 Setpoints for the Batching App

Super ↓ Setpoint

In the Batching App the only available setpoint sections are I/O 1 to 3 inputs which are covered on [page 126](#). All output settings depend on the type of batching app that is running (2 Speed, Ingredient, Indep, or Fill Discharge). Targets and Preacts are all set from a long press on the **SELECT** key or under the setpoint menu below.

1. With the indicator powered up and in normal operating mode, press and hold **F1** ...
Pass is now displayed, prompting the technician or user to enter the password.
2. Key in the Supervisor Password (1793) and press **←** ...
SuPEr is now displayed.
3. Press **▼** ...
SETPNT is now displayed.
4. Press **▼** ...
Edit is now displayed. Use this to edit values for outputs, preacts and to choose the type of input.

Inputs

Setpoint ↓ Edit ↓ I/O1

I/O 1 to I/O 3 stands for input 1 to 3. Use this to assign a function to Input 1 when an external switch is tripped.

5. Press **▼** ...
I/O1 is now displayed. This is the weight value for setpoint 1.
6. Press **▼** ...
StArt is now displayed. This is the default value for **I/O1**.

- Use **◀** or **▶** to toggle between the choices and press **↵** to accept the displayed choice...

I/O1 is now displayed.

- Repeat steps 6 through 8 for **I/O2** (Input 2) and **I/O3** (Input 3).

- When finished, press **▶** ...

I/O 4 is now displayed.

Outputs

Setpoint ↓ Edit ↓ I/O1 → I/O2 → I/O3 → I/O4

I/O 4 to I/O 6 stands for Output 1 to 3. Use this to assign a function to Output 1 when an external switch is tripped. Select the output from I/O 4 to I/O 6 and set the target weight for that setpoint to work from. In the Batching App the Setpoint target values work differently depending on the Mode that is running.

- From **I/O4**, press **▼** ...

The target weight for I/O 4 now flashes.

- Key in the new target weight and press **↵** ...

I/O4 is now displayed.

- Press **▶** ...

I/O5 is now displayed.

- Repeat steps 10 through 12 for **I/O 5** (Output 2) and **I/O 6** (Output 3).

- When finished, press **▶** ...

PRACT4 is now displayed.

Preact

Setpoint ↓ Edit ↓ I/O1 → I/O2 → I/O3 → I/O4 → I/O5 → I/O6 → Preact 4

Preact: Preacts can be used to compensate for product weight that continues to fill into a bag or container after the setpoint output turns off and before the final weight stabilizes. Key in values for these items if Preacts are set to Manual or Auto. The entered values are used in either case but for Auto preacts the value is adjusted automatically by the indicator as it runs multiple batches. In other words it learns what the correct preact should be. The actual cutoff weight will equal the entered setpoint value minus the preact value.

- With **PRACT4** displayed, press **▼** ...

The current value is now displayed for preact 4 (which is associated with output 1).

- Press **↵** to accept the displayed value or key in a new value and press **↵** to accept...

PRACT4 is now displayed.

- Press **▶** ...

PRACT5 is now displayed.

- Repeat steps 15 through 17 for **PRACT5** and **PRACT6**.

- When finished, press **▲** until **Edit** is displayed.

Print

Setpoint ↓ Edit → Print

- Press **▶** ...

Print is now displayed. Use this to print the settings under **SETPNT**.

- Press **▼** ...

Port 1 is now displayed.

- Press **F1** to abort the print process or press **▶** to scroll to the desired port and press **↵** to print the information...

Print is now displayed after either action.

Reset

Setpoint ↓ Edit → Print → Reset

23. Press ► ...
RESET is now displayed. Use this to reset the settings under Edit to factory defaults.
24. Press ▼ ...
No is now displayed.
25. Press **F1** to abort the reset or press ► ...
YES is now displayed.
26. Press ◀ to reset the settings to factory defaults...
RESET is now displayed.
27. Press ▲ ...
SETPNT is now displayed.

8.1.3 Setpoints for the In-Motion App

The setpoints for the In-Motion App all work from Outputs I/O 4 to I/O6 as shown below in a useful guide to best set up the outputs for In-Motion App.

For the best In-Motion weighing performance the outputs must be set the following way:

I/O4: Mode set to Act in - Backlight Set to: RED (UNDER)

I/O5: Mode set to Act in - Backlight Set to: GREEN (ACCEPT)

I/O6: Mode set to Act above - Backlight Set to: ORANGE (OVER)

1. Press and hold **SELECT** key...
I/O 4 is now displayed.
2. Press ▼ ...
I/O 4LO is displayed. A weight value equivalent to about 10 divisions is recommended.
3. Press ▼ and enter the I/O 4 Lo value.
4. Press ◀ ...
I/O 4LO is now displayed.
5. Press ► ...
I/O 4HI is now displayed. The **I/O 4Hi** value should be entered as the minimum accept Target weight value
6. Press ▼ and enter this value and then press ◀ ...
I/O 4HI is now displayed.
7. Press ▲ until **I/O 4** is displayed
8. Press ► ...
I/O 5 is now displayed.
9. Press ▼ ...
I/O 5LO is displayed. The **I/O 5LO** value is also the minimum accept Target weight and **must equal** the entered **I/O 4HI** value.

10. Press ▼ and enter the same as the **I/O 4HI** value and press ↵ ...
I/O 5LO is now displayed
11. Press ► ...
I/O 5HI is now displayed. The **I/O 5HI** value is the maximum accept Target weight
12. Press ▼ and enter this value and then press ↵ ...
I/O 5HI is now displayed
13. Press ▲ ...
I/O 5 is now displayed
14. Press ► ...
I/O 6 is now displayed
15. Press ▼ and enter **the same** as the **I/O 5HI** value and press ↵ ...
I/O 6 is now displayed
16. Press ▲ until the display returns to normal operation



Note: Required settings for proper checkweigher operation
I/O 4 Lo = min 1 division, maximum is up to the weight of lightest item
I/O 4 Hi = min Accept wt
I/O 5 Lo = min Accept wt
I/O 5 Hi = max Accept wt
I/O 6 = max Accept wt

Setting No Weight Mode Backlight Color

This setting allows users to configure the indicator's backlight behavior during the weighing process. Setting the backlight color here controls the display color in the time between an item entering and existing the photoeye.

1. From the User Menu (password 111), press ▼ ...
TIME is now displayed
2. Press ► until **BACKIt** is displayed
3. Press ▼ ...
Color is now displayed
4. Press ▼ ...
The current choice is now displayed.
5. Press ► until **NoNE** is displayed and press ↵ ...
Color is now displayed
6. Press ▲ to return to normal operation...
SAvE No is now displayed.
7. Press ► to scroll to **SAvEYES** and press ↵ to save the changes.

8.1.4 Setpoints for the Grading App

All Grading band settings are set up in the Supervisor Menu under the Grading Submenu or directly from the front panel by pressing the F1 key. In the Grading app all setpoints are programmed to be outputs. This means the 1st 6 grading bands can be linked to individual light stacks that can be above the grading bin to help the operator know which bin the graded item needs to go in.

8.1.5 Tare

Super ↓ Setpoint → Tare

When Preset Tare is enabled within the Admin Menu the operator can recall up to 10 pre-stored Tares by pressing the Tare key and entering in the preset tare number from 1 to 10. If Preset Tare is not enabled, skip to step 7.

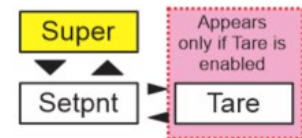

If it is enabled continue to the next step.

- From **SETPNT**, press **▶** ...

TARE is now displayed.

Use this to:

- set values for up to 10 preset tares
- print the values of the preset tares
- reset all preset tares to factory defaults of 0

The following steps describe the procedures.

Tare Register 1-10

Tare ↓ Edit ↓ Tare 1-10

- Press **▼** ...

Edit is now displayed.

- Press **▼** ...

tArE 1 is now displayed. This is the first of the 10 preset tare values you can set.

- Press **▼** ...

The current value is displayed with a flashing right digit.

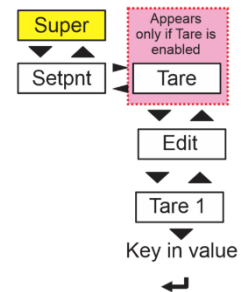

Note: If the active unit of measure is lb-oz then tare weights must be entered in the oz equivalent. To enter 2 lb 4.5 oz you would need to enter 36.5 oz (2 lb = 32 oz plus the 4.5)

- Press **←** to accept the displayed value or key in a new value and press **←** to accept ...

tArE 1 is now displayed.

- Press **▶** ...

tArE 2 is now displayed.

- Repeat steps 4 through 6 for **tArE 2** through **tArE 10**. Press **TARE** when finished ...

Edit is now displayed.

Printing

Tare ↓ Edit → Print

Print: This allows users to choose which available connection port Print Commands are sent to: Port1, Port 2, or USB. A USB drive must be plugged into the USB port for any data to be Printed/Saved.

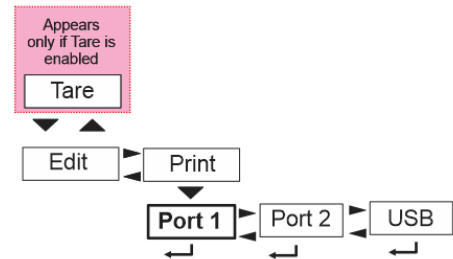

8. Press **▶** ...

Print is now displayed. Use this to print the preset tare values.

9. Press **▼** ...

Port 1 is now displayed.

10. Press **F1** to abort the print process or press **▶** to scroll to the desired port and press **↵** to print the information ...

Print is now displayed after either action.

Reset

Tare ↓ Edit → Print → Reset

Reset: Use this to reset all the preset tares to the factory default of 0.

11. Press **▶** ...

rESEt is now displayed.

12. Press **▼** ...

no is now displayed.

13. Press **F1** to abort the reset or press **▶** ...

YES is now displayed.

14. Press **↵** to reset the settings to factory defaults ...

rESEt is now displayed.

15. Press **▲** ...

TARE is now displayed.

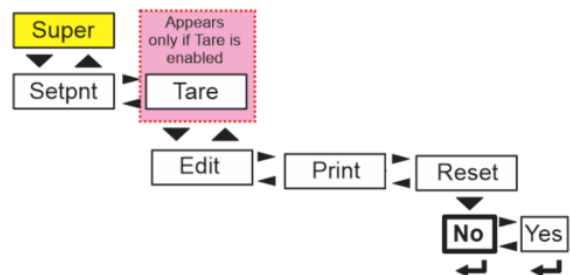

8.2 Accumulation Supervisor Menu

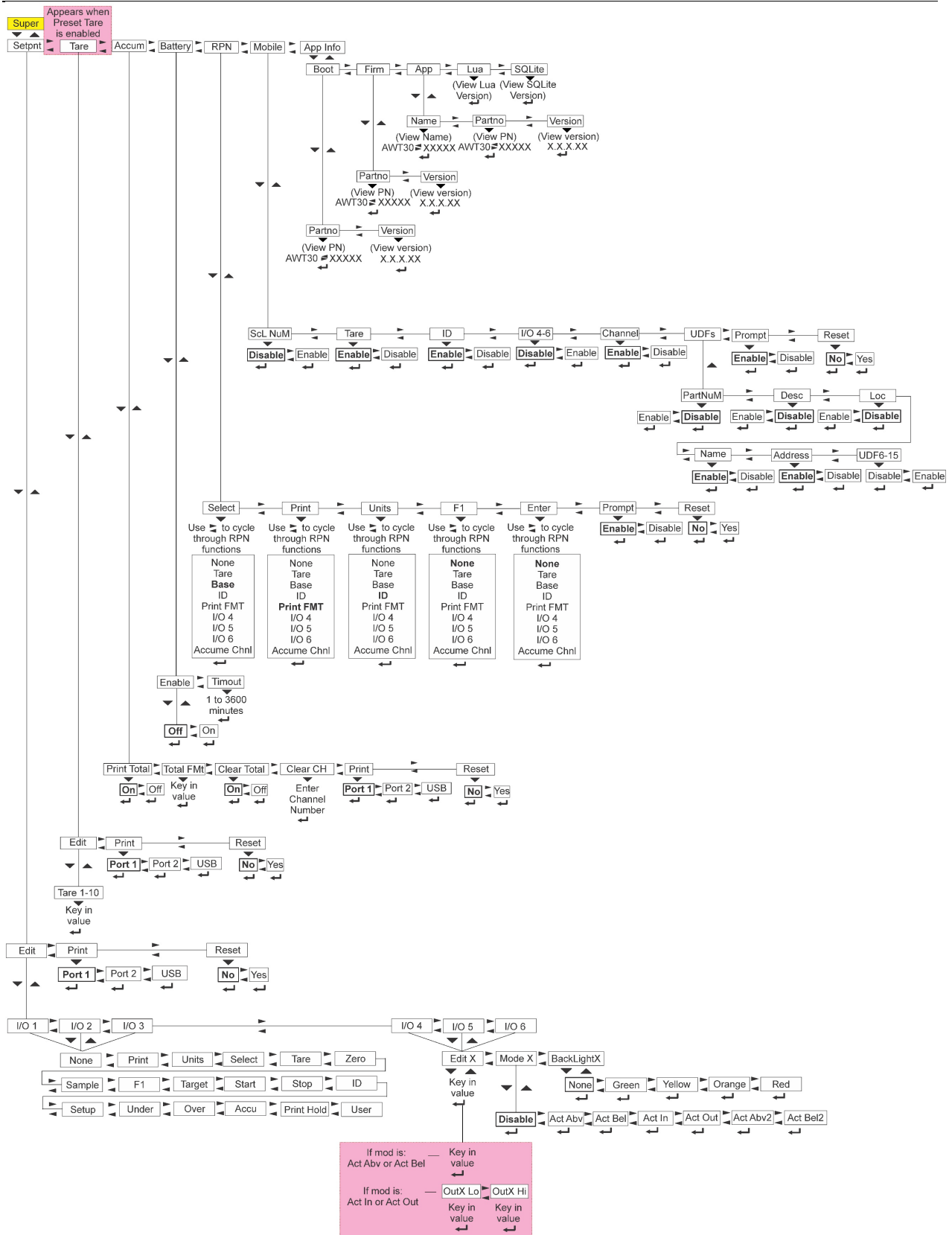

8.2.1 Accumulation App Supervisor Menu Setup

Super ↓ Setpoint → Tare → Accum

Print Total: This allows users to print the Total Print Format by holding down the **PRINT** key. This prints an accumulated total for the day, shift, etc. rather than the current value of the current run. If enabled, during normal operation the technician or user can press and hold **PRINT** for three seconds and the selected total print format (see step 8 below) will be sent out any port that is set up to printed.



Total Print Format: This allows users to choose a Print Format by entering the corresponding Print Format Number. To see a complete list of available Print Formats go to [page 209](#).

Clear Total: When enabled, this allows users to clear a Transaction at the end of an accumulation by pressing and holding the **PRINT** key. The Transaction Totals will be printed followed by clearing the Transaction Totals for that Accumulator Channel. The display will flash **PRN-TOT**. When disabled, the only way to clear a Transaction is through the Supervisor Menu by using the Clear Channel or Reset function.

Clear Channel: This is used to clear the Transaction for just the selected Accumulator Channel. Enter the desired Accumulator Channel to clear and press the key.

Print: This allows the supervisor to print all the Accumulator Channel Transaction Totals. Choose which available connection port to print the report is to be sent out of: Port1, Port 2, or USB. A USB drive must be plugged into the USB port for any data to be Printed/Saved.



Reset: This allows users to reset all the accumulator channel totals back to 0.





1. With the indicator powered up and in normal operating mode, press and hold **F1** ...
Pass is now displayed, prompting the technician or user to enter the password.
2. Key in the Supervisor Password (1793) and press  ...
SuPEr is now displayed.
3. Press  ...
SETPNT is now displayed.
4. Press  until **ACCUM** is displayed. Use this to set the items relating to accumulation. Under **ACCUM** users can do the following:
 - Enable/Disable the ability to print the accumulated total (**Prt TOT**).
 - Key in a print format number for printing the total accumulated weight information (**ToT Fmt**).
 - Enable/Disable the ability to clear the total accumulation information when the total is printed (**clr TOT**).
 - Clear a specific Accumulator Channel's total (**clr CH**).
 - Print the accumulation report for all 200 memory channels (**PrInt**).
 - Reset all 200 accumulator memory channel values to 0 (**RESEt**).

The following steps describe the procedure to set these items.

Print Total

Accum ↓ Print Total

5. From **ACCUM**, press  ...
Prt TOT is now displayed.
6. Press  ...
ON is now displayed.





7. Press  to keep the print total function disabled or press  or  to toggle to **OFF** and press  to enable printing of the accumulated total...
Prt TOT is now displayed.



*Note: If the Print Return to Zero setting is on, after the **PRINT** key is pressed, the scale must return to inside the Gross Zero Band before the next Print Transaction can be initiated.*





Total Format

Accum ↓ Print Total → Total Format

8. Press  ...
ToT FMT is now displayed. This stands for the total print format.
9. Press  ...
The current print format number is now displayed with a flashing right-most digit. (Default is format 8)
10. Press  to accept the existing setting or key in a new print format number and press  to accept ...
ToT FMT is now displayed.





Clear Total

Accum ↓ Print Total → Total Format → Clear Total

11. Press  ...
clr TOT is now displayed. This stands for clear total. Choose “on” to enable clearing the accumulated total when the **PRINT** key is pressed and held. Choose **OFF** to disable this function. If enabled, the total is cleared if the user presses and holds the **PRINT** key for three seconds. The message **CLEARED** will flash. If off, the Accumulator Totals can only be cleared from the Supervisor Menu by using Clear Channel or Reset functions.
12. Press  ...
The current setting is now displayed.
13. Press  or  to toggle between the option and press  to make a choice...
clr TOT is now displayed.



Clear Channel

Accum ↓ Print Total → Total Format → Clear Total → Clear Channel

14. Press  ...
clr CH is now displayed.
15. Press  ...
A numeric entry screen is displayed.
16. Enter the Accumulator Channel number (1 to 200) and press  ...
CLEAR is now displayed.
17. Or Press  to switch to **AbORT** to cancel clearing process.

Print

Accum ↓ Print Total → Total Format → Clear Total → Clear Channel → Print

18. Press  ...
Print is now displayed. This stands for print the accumulation report. Choose a port to print the accumulated totals report for all 200 memory channels.
19. Press  ...
Port 1 is now displayed.

20. Press **F1** to abort the print process or press **▶** to scroll to the desired port and press **↵** to print the information...
Print is now displayed and the print data is sent to the printer connected to the selected port.

Reset

Accum ↓ **Print Total** → **Total Format** → **Clear Total** → **Clear Channel**

→ **Print** → **Reset**

21. Press **▶** ...
rESEt is now displayed. Use this to reset all the Accumulator Channels back to zero.
22. Press **▼** ...
No is now displayed. With **No** displayed, press **F1** to abort the reset.
23. Press **▶** ...
Yes is now displayed
24. Press **↵** to clear all accumulator data stored in channels 1 to 200...
rESEt is now displayed
25. Press **▲** ...
Accum is now displayed
26. This completes the Supervisor menu for the Accumulation application. Repeatedly press **F1** until the indicator returns to normal weighing mode. The current weight value is displayed.

8.3 Truck In & Out App Supervisor Menu

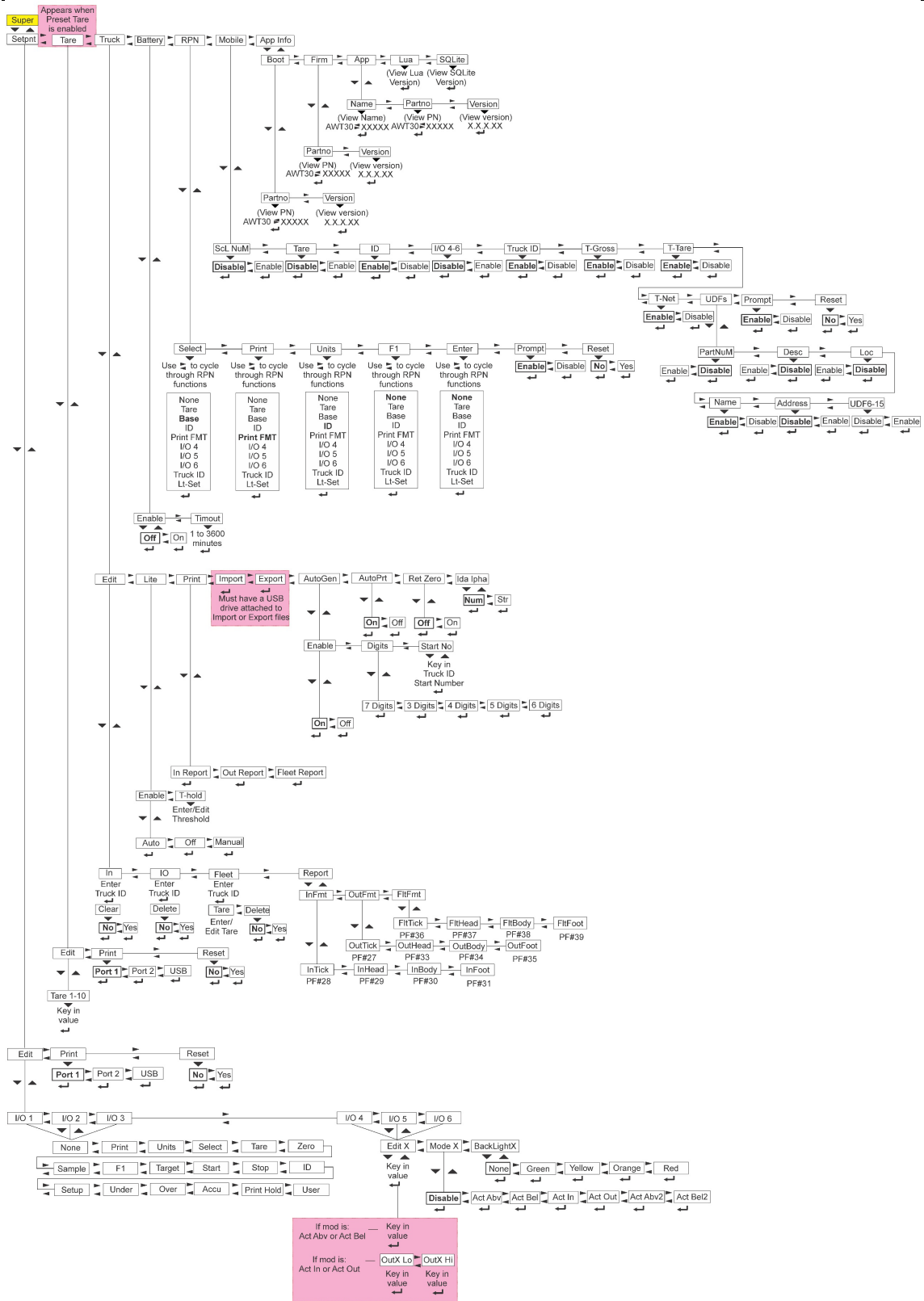

8.3.1 Truck In & Out App Supervisor Menu Setup

Super ↓ Setpoint → Tare → Truck

Edit: This allows users to set up Fleet IDs with known Tare Weights, enter or delete Truck IDs, or edit the print format for Inbound, Outbound, and Fleet Reports

Lite: This allows users to manage the Stop Light Functions. In the Threshold field, users can enter or edit the threshold weights for the backlight and stop light (outputs) to signal for trucks to Stop and Go.

Print: This allows users to choose which of the three Truck In & Out Reports prints when prompted Truck-In Report, Truck-Out Report, or Fleet Report.

Import: This allows for transfer of a Truck Scale Database File from a USB memory device inserted into the USB port of the indicator.

Export: This allows for transfer of a CSV (Comma Separated Values) file containing the Truck Scale Database to a USB memory device inserted into the USB port of the indicator.

Auto Gen: This allows the indicator to auto generate a Truck ID when the F1 key is pressed.

Auto print: This allows the indicator to automatically print the Inbound or Outbound weight ticket once the weight becomes stable. This is on by default. When turned off, the operator **MUST** press the **PRINT** key to print and Inbound or Outbound ticket.

RetZero: This forces the scale operator to remove the truck from the scale and the weight to return to zero before the next inbound or outbound truck ID / transaction can take place.

IdAlPhA: Allows alphabetic character entry from the front panel of the indicator.



Note: When a USB keyboard is attached to the ZM223 alphanumeric truck IDs can be entered without activating IdAlPhA.

1. Press and hold **F1** ...
PASS is now displayed.
2. Key in the Supervisor Password (1793) and press **←** ...
SuPER is now displayed.
3. Press **▼** ...
SETPNT is displayed.

Edit

Truck ↓ Edit

Edit: This allows users to clear unnecessary Inbound/Outbound records, delete individual Outbound Records, create new or edit existing Fleet Truck IDs and their Tare Weights, or delete individual Fleet Truck Records.

4. From **SETPNT**, press **▶** ...
TRUCK is now displayed.
5. Press **▼** ...
Edit is now displayed.
6. Press **▼** ...
IN is now displayed.

7. Use the ◀ or ▶ keys to scroll the choices (**in**, **io**, **FLEEt** and **REPort**).
 - IN**: Use this to clear an existing Inbound transaction that has not been closed by an Outbound transaction.
 - IO**: Use this to delete a Truck I/O record.
 - FLEET**: Use this to create, edit or delete a Fleet ID record.
 - REPORT**: Use this to print a reports showing all the inbound and out bound Truck IDs still active in the indicator
8. Press the ↵ key to make a selection.

Clear Inbound Records

Truck ↓ Edit ↓ IN

9. From **IN**, press ▼ ...
 - A value entry screen is displayed.
10. Key in the Truck ID and press the ↵ key ...
 - CLEAR** is displayed.
11. Press ▼ ...
 - No** is displayed.
12. Press ▶ to toggle between **YES** and **No**.
13. Press ↵ when **YES** is displayed to clear the Inbound record ...
 - buSy** is briefly displayed and then **IN** is displayed.
14. Repeat from step 9 for any other inbound records you want to remove.



Clear Outbound records





Truck ↓ Edit ↓ IN → IO

15. From **IN**, press ▶ ...
 - IO** is now displayed
16. Press ▼ ...
 - A value entry screen is displayed.
17. Key in the Truck ID and press the ↵ key ...
 - dELEtE** is displayed.
18. Press ▼ ...
 - No** is displayed.
19. Press ◀ or ▶ to toggle between **YES** and **No**.
20. Press ↵ when **YES** is displayed to delete the Outbound record. This will delete all transaction totals for the selected Truck ID ...
 - buSy** is briefly displayed and then **IO** is displayed.
21. Repeat from step 15 for any other outbound records you want to delete

Edit Fleet records

Truck ↓ Edit ↓ IN → IO → Fleet



22. From **IO**, press  ...
FIEEt is now displayed
23. Press  ...
A value entry screen is displayed.
24. Key in the Fleet Truck ID and press  ...
If this is an existing ID, **FIEEt** is briefly displayed then **TArE**.
If this is a new ID, **NOT FNd** (not found) is briefly displayed followed by **AddING**, followed by **TArE**.

If the ID entered is already an inbound or outbound number, the display will say **CANt**. In this case that Inbound or Outbound Number needs to be canceled, or a different Fleet Number must be used. With **ArE** displayed you can either edit the Fleet Tare weight or enter a Fleet ID.
25. With **TArE** displayed, press  ...
dELEtE is displayed.
26. Press  ...
No is now displayed.
27. Press  ...
YES is now displayed.
28. To delete the Fleet ID. To edit a Fleet Tare weight, press  ...
buSy is briefly displayed, followed by **FIEET**.
29. With **TArE** displayed you can either edit the current Fleet Tare weight, abort, or store a new live weight of the empty Fleet Truck on the scale.



Viewing a Fleet Tare Weight:

30. With the scale at Zero and from **TArE**, press  ...
The current Tare Value is displayed. If you do not need to change the Tare Value, Press **F1** to abort.

Editing a Fleet Tare Weight:

31. With the scale at Zero and from **tArE**, press  ...
The current Tare Value is displayed.
32. Key in the Tare Value and press  ...
TArE is now displayed.

Saving a New Fleet Tare Weight Using a Live Weight:

33. With the empty Fleet truck on the scale and from **TArE**, press  ...
The indicator will now grab the live weight of the truck that is on the scale to use at this Tare Weight for this Fleet ID.
34. Press  to save the new Fleet Tare Weight...
TArE is now displayed.



Note: If the Tare value is not greater than the Gross Zero Band, the ID will not be saved.

New Fleet Truck ID

If the weight on the scale is below the Gross Zero Band (GZB) then **0** is displayed. Use numeric entry to manually enter the Fleet truck tare weight.

Otherwise the Saved live weight is displayed. Press **←** to store this value or use numeric entry to manually enter the Fleet truck tare value.

Existing Fleet Truck ID

If the weight on the scale is below the GZB the PT annunciator is illuminated and the stored Fleet tare weight is displayed. Use the numeric entry prompt to change or press **←** to continue to use this as the Fleet truck tare value.

Otherwise, the Saved live weight is displayed. Press **←** to store the live weight or use numeric entry to manually enter the Fleet truck tare value. After pressing **←** to save the value, **tArE** is displayed.

35. To add more Fleet ID's press the **▲** key to return to step 22.

Delete Fleet ID

36. From **FIEEt**, press **▼** ...
A numeric entry screen is now displayed.

37. Enter the Fleet ID and press **←** ...
TArE is now displayed.

38. Press **▶** ...
dELEtE is displayed.

39. Press **▼** ...
No is displayed.

40. Press **◀** or **▶** to toggle between **YES** and **No**.

41. Press **←** to select an option...

If you choose **no**, the ID is not deleted, and the display shows **dELEtE**.

If you choose **YES**, **buSy** is briefly displayed, the ID is deleted and **FLEEt** is displayed. To delete more Fleet IDs return to step 36 or press **▲** to return to normal operation.

Editing Report Formats

Truck **↓** Edit **↓** IN **→** IO **→** Fleet **→** Report

42. From **FIEEt** press **▶** ...

REPort is displayed. This menu item lets you assign a print format number to the various print tickets and reports. The choices are Inbound Report (**INFmt**), Outbound Report (**OutFmt**), and Fleet Report **FLEFmt**. Each one has a separate print format assigned for the Ticket Transaction, the Header, the Body and the Footer.

43. Press **▼** ...

INFmt is now displayed.

Under **INFMt** are these items:

IN Tick: This defines which print format is used during the Inbound ticket transaction.

IN HEAD: This defines which print format is used for the header or top of the Inbound report.

In body: This defines which print format is used for the body of the Inbound report

In Foot: This defines which print format is used for the footer or bottom of each Inbound report.

Under **OutFMt**, there are the same items except the prefix is changed to **Out:**

Out Tick, Out HEAD, Outbody, OutFoot

Under **FltFMt**, there are the same items except the prefix is changed to **Flt:**
FltTick, FltHEAD, Fltbody and **FltFoot**.

Report Print Formats

For example, the Ticket transaction might print the Truck ID, the time/date, and associated weight values for the type of transaction.

The Header might print the scale owner's company name, address and time/date of the report and appropriate labels to align with the information contained in the Body of the report.

The Body would print the Truck ID and associated weights and times (Inbound only). The Body print format performs automatic "loop" printing of the data contained in the print format. The "loop" is controlled by the Truck In, Truck Out and Fleet ID's print tokens and will continue to repeat the print format for all ID's that are stored in their respective areas of the database.

The Footer might only print "End of xxxxx Report" or just send a form feed character for proper paper advance upon completion.

Report Printing Structure

When a report is printed, all 3 associated print formats, Header, Body and Footer, are automatically sent to the assigned or binded port. Proper editing of these print formats using the internal Editor or the PC software application tool may be necessary for specific application requirements.

Editing of a print format requires access to a password protected menu and will not be covered in this manual.

Default Report Print Format Numbers

Report	Ticket	Header	Body	Footer
Inbound	48	49	50	51
Outbound	52	53	54	55
Fleet	56	57	58	59

44. From **REPort**, press ▲ ...

Edit is displayed.

Lite Menu

Truck ↓ Edit → Lite

Lite: This allows users to configure setpoint 1 & 2 to control an external traffic light, device based on GTN operations, or the indicator's backlight conditions. This can be likened directly to the RPN/Lite function to change the backlight and output.

- Press 1 and the RPN/Lite key will turn on output 1 (and switch the back light Green)
- Press 2 and the RPN/Lite key will turn on output 2 (and switch the back light Red)

45. From **Edit**, press ► ...

LitE is displayed.



Note: Outputs #1 and #2 must be enabled for the set point controls to function properly.

46. Press ▼ ...

EnAbLE is displayed. Choose from these three options under enable:

Manual: BOTH the set point outputs #1 & #2 and the serial commands for the XR4500TL are controlled by the RPN light function.

Auto: This can work with the weight threshold to turn the backlight to red once the weight threshold is reached.

BOTH the set point outputs #1 & #2 and the serial commands for the XR4500TL are controlled as follows:

- Set point #1 is active for green light when scale is considered at ZERO while inside gross zero band, or when the **PRINT** key has been processed. (Scale Configuration Parameter)
- Set point #2 is active for red light when gross weight is above the threshold value.
- Set point #3 is available for standard configuration (cutoff) as long as the battery saver feature is not used.

OFF: Set point controls are controlled by standard configuration settings (cutoffs) and **ONLY** the XR4500TL works when the RPN light function is enabled.

47. From **EnAbLE** press the **▶** key ...

T-Hold is displayed. This stands for Threshold. Use this to configure the weight value that must be exceeded for the light control to activate the red light (set point #2) when configured for the AUTO mode of operation

48. From **T-Hold** press **▲** ...

LitE is now displayed.

Print Menu

Truck **↓** **Edit** **→** **Lite** **→** **Print**

49. From **LitE**, press **▶** ...

Print is displayed. This menu item allows users to print the transaction reports.

IN RPt: Prints the report of all the Trucks that have recorded an Inbound transaction but have yet to complete the Outbound transaction.

OUT RPt: Prints the report of all the Truck ID's and associated totals that have completed an Outbound transaction.

FLT RPt: Prints the report of all the Fleet Truck ID's and tare weights and associated totals.

50. To exit the reports level, press **▲** ...

PriNt is displayed.

Reprinting Tickets

Truck **↓** **Edit** **→** **Lite** **→** **Print**

To reprint any other tickets, follow the following steps:

51. Press and hold the **F1** key

52. Key in the Supervisor Menu password (1793) ...

SuPEr is now displayed.

53. Press **▼** ...

Setpnt is now displayed

54. Press **▶** ...

Truck is displayed.

55. Press **▼** ...

Edit is now displayed

56. Press **▶** until **Print** is displayed.

57. Press **▼** ...

In rPt is now displayed

58. Use the **◀** or **▶** keys to scroll through the other three choices. When your choice is displayed, press **↵** to print the report. Below are explanations for each report:

in rPt: Prints the report of all the Trucks that have recorded an Inbound transaction but have yet to complete the Outbound transaction. Individual or all Inbound records can be cleared in the Supervisor menu.

out rPt: Prints the report of all the Truck ID's and associated totals that have completed an Outbound transaction. Individual or all Outbound records can be deleted in the Supervisor menu.

FLt rPt: Prints the report of all the Fleet Truck ID's and tare weights and associated totals. Individual or all Fleet records can be deleted in the Supervisor menu.

Import

Truck ↓ Edit → Lite → Print → Import

The Import menu allows for transfer of a Truck Scale database file from a USB memory device when inserted into the USB port of the indicator.

For a typical truck scale operation the only reasons to import a database would be to:

- Add Fleet Truck ID's and Tare weight records into the scale without having to use the EDIT menu
- Edit existing totals to correct errors or missing weighments such as failure to record an Outbound transaction or using an incorrect Truck ID.

To successfully Import the truck scale database into the indicator the file must be in the proper CSV (comma separated value) format. To insure that the CSV file format is acceptable, the following procedure is recommended. Perform an In/Out transaction, and if the operation uses Fleet trucks, add at least one Fleet Truck ID/Tare weight in the EDIT menu. Then EXPORT the database file to the USB thumbdrive. The database file will show the required data fields that must be maintained.

Open the file using Excel and copy and paste a row containing the entered Truck values into the number of rows necessary. Edit the pasted rows with the required data and be sure to put 0's into unused columns.

Save the file on the thumbdrive and IMPORT back to the indicator to update the Truck database



Note: The USB thumbdrive must be installed before accessing the Import or Export menus.

59. From **PriNt**, press ► ...

IMPort is now displayed.



Note: The database can contain up to 10000 separate truck records. Importing a database file will overwrite all existing Truck records stored in the indicator. This database file includes all Truck In/Out and Fleet ID's, open Inbound transactions with time, date and weight, and Gross, Net, Tare, and Transaction Count totals for completed In/Out and Fleet transactions.

60. With **IMPort** displayed, press ▼ ...

buSy and **doNE** are briefly displayed as the database file is imported.
IMPort will be displayed when finished.

Export

Truck ↓ Edit → Lite → Print → Import → Export

The Export menu allows for transfer of a CSV (Comma Separated Values) file containing the Truck Scale database to a USB memory device when inserted into the USB port of the indicator.

61. From **IMP**ort, press  ...

EXPort is displayed.

62. Press  ...

buSy and **doNE** are briefly displayed as the database file is exported.
EXPort is displayed when finished.

Below is a sample of a CSV file structure:

truckid	tareFleet	weight1	weight1date	weight1time	grossTotal	netTotal	tareTotal	transCount	units
111	0	0			300000	200000	100000	10	lb
222	0	0			800000	400000	400000	20	lb
123	12300	0			1500000	1000000	500000	30	lb
456	14550	0			39550	25000	14550	1	lb
1	11240	0			62480	40000	22480	2	lb
5	0	16210	2/3/2025	4:51:00	0	0	0	0	lb



Reset

Truck ↓ Edit → Lite → Print → Import → Export → Reset

63. From **EXP**ort, press  ...
rESET is now displayed.

64. Press  ...

IN is displayed.

65. Use  and  to scroll through the choices: **IN**, **IO**, **FLEET** or **ALL**. With the type of record you want to clear or delete displayed, press  ...

No is displayed.

66. Press  to select **YES**.

67. Press  to clear the record ...

The display will show **buSy** and then return to **IN**, **IO**, **FLEET** or **ALL** depending on which menu item was selected.



*Note: Resetting the **IN** records will clear all stored Inbound records that have not yet completed an Outbound transaction.*

*Resetting the **OUT** records will delete all stored Truck I/O ID's and associated Totals. Reset the **FLEET** records will delete all stored Fleet Truck ID's, Tare weights and associated Totals.*

*Deleting **ALL** will delete all the above Truck records from the database.*

68. Repeatedly press  to exit back to normal operation

8.4 Counting App Supervisor Menu

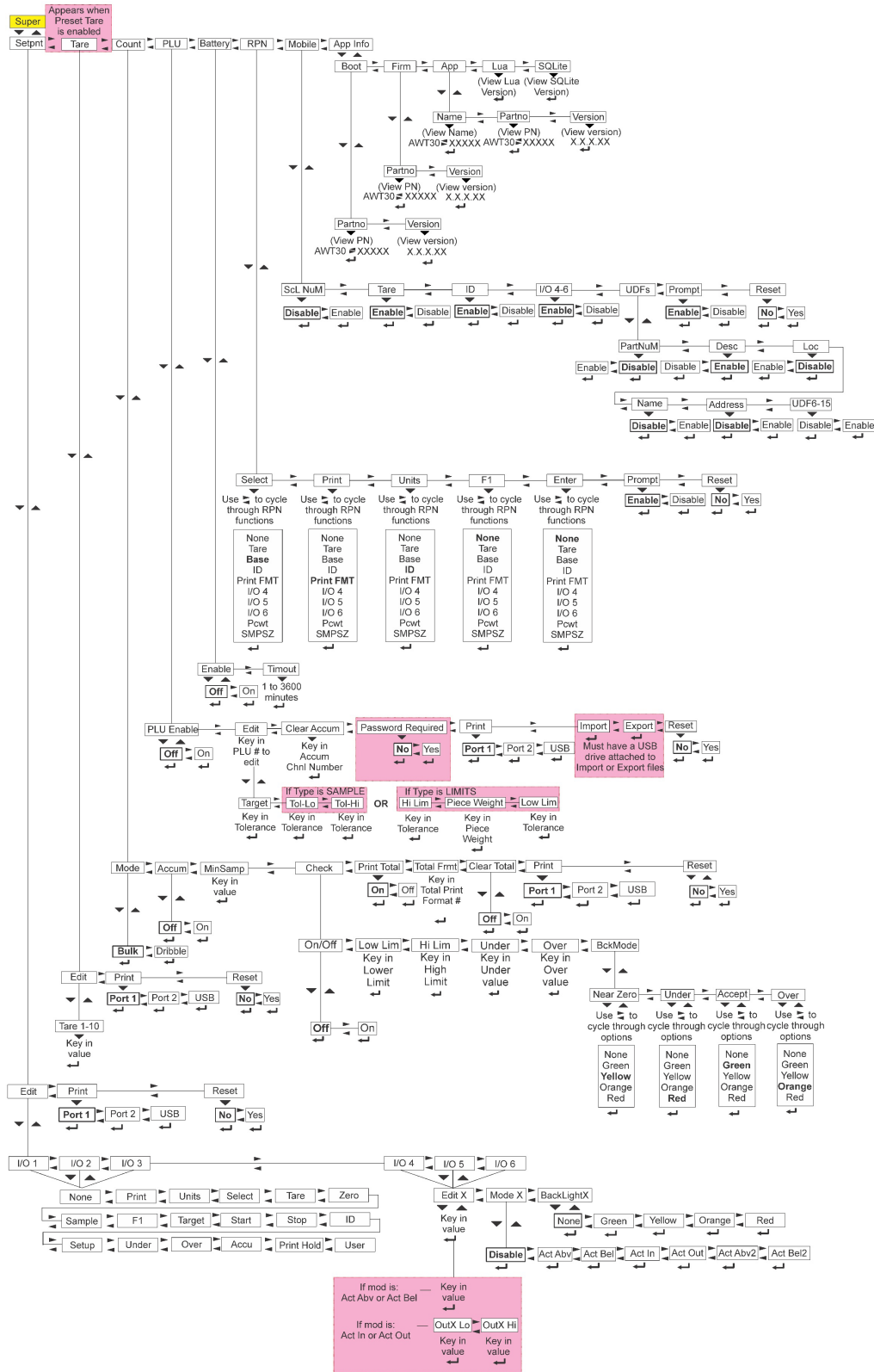

8.4.1 Counting App Supervisor Menu Setup

Super ↓ Setpoint → Tare → Count

Mode: This controls if the indicator uses Bulk or Dribble sampling.

Bulk: In bulk sampling the user enters the specified number of items on the scale all at once (in bulk) and the scale automatically starts to calculate piece weight when the weight stabilizes. The count is then displayed.

Dribble: In dribble sampling method users place the specified number of items onto the scale and ready, press the **F1/SAMPLE** key and the scale calculates piece weight and then shows the count.

Accum: This allows the indicator to accumulate multiple Count Totals together. Each time the user presses the **PRINT** key the Printed Count Quantity is added to the Accumulated Count Total. To print the Accumulated Print Totals press and hold the **PRINT** key.

Min Sample Size: This controls the minimum sample size required when sampling. 5 is the default minimum sample size.

Check: This controls the Checkcounting feature. When off, the bar graph annunciator features will not work.

When enabled, the top check weight bar graph will turn on and work off of the set count quantity. If the count quantity is in the accept window the middle ACCEPT annunciator will light up and the back light display will turn GREEN. If the count is under the ACCEPT quantity window the left side UNDER annunciator will light up and the backlight will turn to RED. If over the right-side bar graph will light up and the backlight will turn ORANGE.

In General Checkcounting the Low and High Limits must be set to control the Accept Count Window. If the accept quantity needed to pack is just 100 parts the Low Limit and High Limit needs to be set to 100 making it so only a count of 100 parts will activate the ACCEPT bar graph segment.

Under Seg Div: This controls the value each segment of Under bar graph annunciator represents. When set to 10 parts, each Under bar graph annunciator segment represents 10 parts.

Over Seg Div: This controls the value each segment of Over bar graph annunciator represents. When set to 10 parts, each Over bar graph annunciator segment represents 10 parts.

Low Limit: This controls the Low Quantity limit.

High Limit: This controls the High Quantity limit.

Backlight Mode: This controls the behavior of the display's backlight color in relation to the checkweighing settings Near Zero, Under, Accept, Over.

Near Zero: This controls the Near Zero backlight color (Default is Yellow).

Under: This controls the Under backlight color (Default is Red)

Accept: This controls the Accept backlight color (Default is Green)

Over: This controls the Over backlight color (Default is Orange)

Print Total: Enables or disables the ability to print totals. Totals are printed automatically at the end of a packrun or at any time by pressing and holding the **PRINT** key.

Total Print Format: This allows users to choose a Print Format by entering the corresponding Print Format Number. To see a complete list of available Print Formats go to [page 209](#).

Clear Total: When enabled, this allows users to clear a Transaction at the end of an accumulation by pressing and holding the **PRINT** key. The Transaction Total will be printed followed by clearing the Transaction Total for that Accumulator Channel. The display will flash **PRN-TOT**. When disabled, the only way to clear a Transaction is through the Supervisor Menu by using the Reset function.

Print: This allows users to choose which available connection port Print commands are sent to: Port1, Port 2, or USB. A USB drive must be plugged into the USB port for any data to be Printed/Saved.

Reset: This allows technicians to reset all counts to 0.

1. With the indicator powered up and in normal operating mode, press and hold **F1** ...
Pass is now displayed, prompting the user to enter the password.
2. Key in the Supervisor Password (1793) and press **←** ...
SuPEr is now displayed.
3. Press **▼** ...
SETPNT is now displayed.
4. Press **▶** until...
COUNT is now displayed. Use this to set the items relating to counting:
 - Select between dribble and bulk mode (**dribBLE** and **bulK**).
 - Accum (**AccuM**).
 - Min Sample Size (**MiNSAMP**).
 - Check (**ChEcK**).
 - Enable/Disable the ability to print the count total (**Prt TOT**).
 - Key in a print format number for printing the total count information (**ToT Fmt**).
 - Enable/Disable the ability to clear the total count information when the total is printed (**clr TOT**). The following steps describe the procedure to set these items.

Mode

Count ↓ Mode

5. Press **▼** ...
ModE is now displayed. There are two modes for sampling: **buLK** and **dribbLE**.
6. With **ModE** displayed, press **▼** ...
dribBLE is now displayed.
7. Press **◀** or **▶** to toggle between the options and press **←** to make a selection...
ModE is now displayed.

Accum

Count ↓ Mode → Accum

8. Press **▶** ...
AccuM is now displayed.
9. Press **▼** ...
OFF is now displayed.
10. To turn on the Accumulation function, press **▶** ...
ON is now displayed.
11. Press **←** ...
AccuM is now displayed.

Minimum Sample Size

Count ↓ Mode → Accum → Minimum Sample Size

12. Press ► ...

MiNSAMP is now displayed

13. Press ▼ ...

5 is now displayed.

14. To change the minimum sample size, key in a new value

15. Press ◀ ...

MiNSAMP is now displayed.

Checkcounting

Count ↓ Mode → Accum → Minimum Sample Size → Checkcounting

16. Press ► ...

ChEck is now displayed.

17. Press ▼ ...

ON/OFF is now displayed

18. Press ▼ ...

OFF is now displayed.

19. Use ◀ or ► to toggle to **ON** and press ◀ to activate Checkcounting mode.

ON/OFF is now displayed.

20. Press ► ...

Low LiM is now displayed

21. Press ▼ ...

100 is now displayed.

22. To change the Low Limit, key in a new value and press ◀ ...

Low LiM is now displayed

23. Press ► ...

Hi LiM is now displayed.

24. Press ▼ ...

100 is now displayed.

25. To change the High Limit, key in a new value and press ◀ ...

Hi LiM is now displayed

26. Press ► ...

U-SEG is now displayed. This stands for Under Segment Division.

27. Press ▼ ...

10 is now displayed.

28. To change the Under Segment Division, key in a new value and press ◀ ...

U-SEG is now displayed

29. Press ► ...





















O-SEG is now displayed. This stands for Over Segment Division.

30. Press ▼ ...

10 is now displayed.

31. To change the Over Segment Division, key in a new value and press ◀ ...







O-SEG (Segment Division) is now displayed.

32. Press  ...
bckModE is now displayed
33. Press  ...
NEAr ZEr is now displayed
34. Press  ...
yEllow is now displayed
35. To change the Backlight Color, use  or  to toggle through the options and press  to make a selection...
NEAR ZEr is now displayed
36. Press  ...
UNdEr is now displayed
37. Press  ...
REd is now displayed
38. To change the Backlight Color, use  or  to toggle through the options and press  to make a selection...
UNdEr is now displayed
39. Press  ...
AccEPt is now displayed
40. Press  ...
GrEEN is now displayed
41. To change the Backlight Color, use  or  to toggle through the options and press  to make a selection...
AccEPt is now displayed
42. Press  ...
OvEr is now displayed
43. Press  ...
OrANgE is now displayed
44. To change the Backlight Color, use  or  to toggle through the options and press  to make a selection...
OvEr is now displayed
45. Press **F1** until **ChEck** is displayed

Print Total

Count ↓ **Mode** → **Accum** → **Minimum Sample Size** → **Checkcounting** →

Print Total

46. Press  ...
Prt TOT is now displayed. This stands for print total.
47. Press  ...
ON or **OFF** is now displayed. Default is **ON**.
48. Press  when **ON** is displayed to enable printing of the count total press  or  to toggle to **OFF** and press  to keep the print total function disabled...
Prt TOT is now displayed.

Total Format

Count ↓ Mode → Accum → Minimum Sample Size → Checkcounting →

Print Total → Total Format

49. Press ► ...

ToT FmT is now displayed. This stands for the total print format.

50. Press ▼ ...

The current print format number is now displayed with a flashing right-most digit.

51. Press ◀ to accept the existing setting or key in a new print format number and press ◀ to accept ...

ToT FmT is now displayed.

Clear Total

Count ↓ Mode → Accum → Minimum Sample Size → Checkcounting →

Print Total → Total Format → Clear Total

52. Press ► ...

clr TOT is now displayed. The message cLr-tot will flash. The total is printed prior to clearing if this was enabled in step 8 above.

53. Press ▼ ...

The current setting is now displayed.

54. Press ◀ or ▶ to toggle between **ON** and **OFF** and press ◀ to make a selection...

clr TOT is now displayed.

Print

Count ↓ Mode → Accum → Minimum Sample Size → Checkcounting →

Print Total → Total Format → Clear Total → Print

55. Press ► ...

Print is now displayed. This stands for "print the count totals report." Choose a port to print the count totals report.

56. Press ▼ ...

Port 1 is now displayed.

57. Press **F1** to abort the print process or press ► to scroll to the desired port and press ◀ to print the information...

Print is now displayed after either action.

Reset

Count ↓ Mode → Accum → Minimum Sample Size → Checkcounting →

Print Total → Total Format → Clear Total → Print → Reset

58. Press ► ...

rESEt is now displayed. Use this to reset all the items under count to the factory defaults.

59. Press ▼ ...

no is now displayed.

60. Press ◀ to abort the reset or press ► ...

YES is now displayed.

61. Press ◀ to reset the settings to factory defaults...

rESEt is now displayed.

8.5 Checkweighing Simple-Level App Supervisor Menu

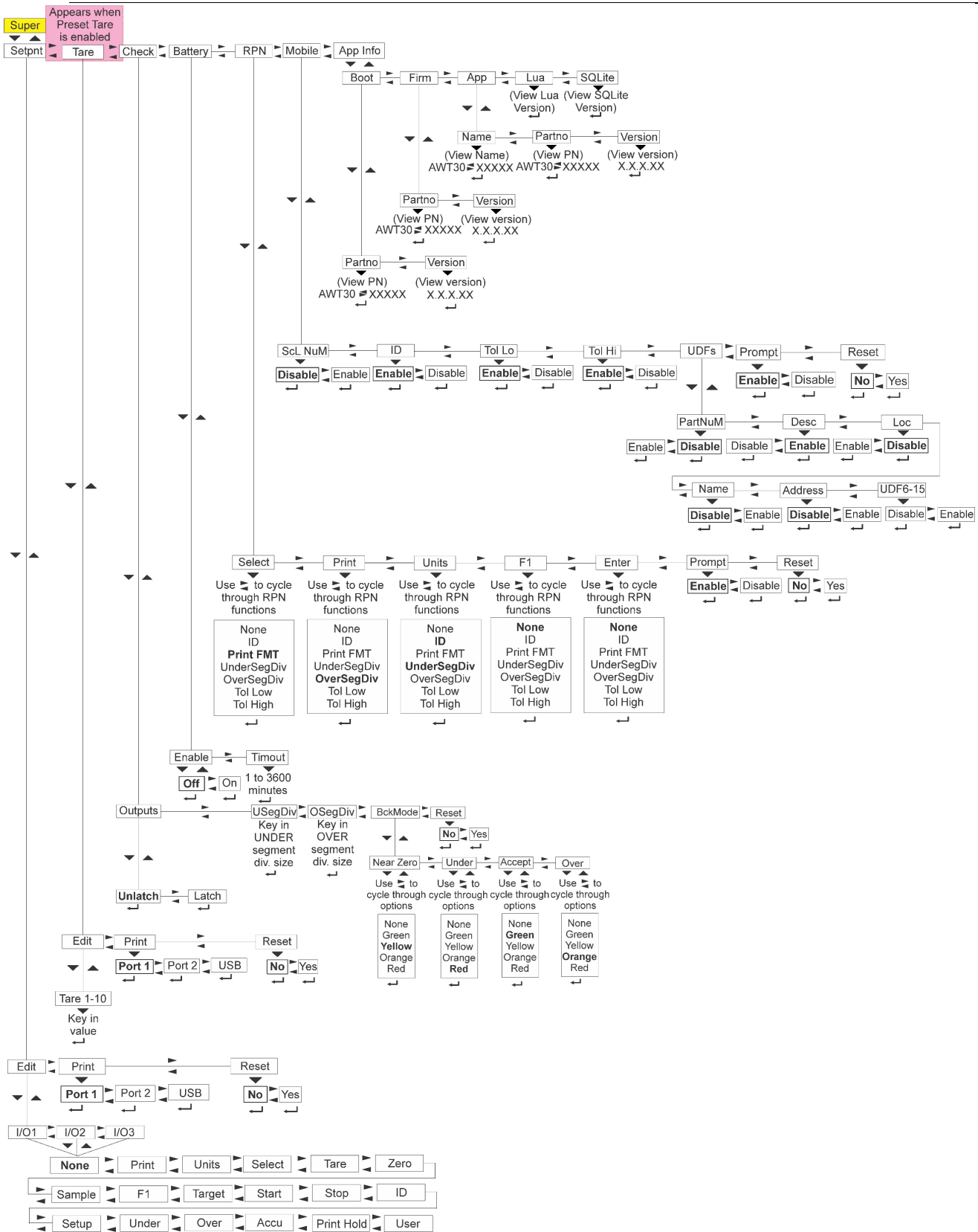

8.5.1 Checkweighing Simple-Level Supervisor Menu Setup

Super ↓ Setpoint → Tare → Check

Outputs: This controls the behavior of the relay controlling any peripheral device connected to the ZM223.

Unlatch: This means that the relay and annunciator will change instantly as the weight swings above and below the output value.



Latch: This means that weights will have to stabilize at or above the output value before the relay or annunciator changes.

Under Seg Div: This controls the value each segment of Under bar graph annunciator represents. When set to 0.05 lbs, each Under bar graph annunciator segment represents 0.05 lbs.

Over Seg Div: This controls the value each segment of Over bar graph annunciator represents. When set to 0.05 lbs, each Over bar graph annunciator segment represents 0.05 lbs.





Back Light Mode: This allows users to select the Back Light Color for the Near Zero, Under, Accept, and Over settings.

Reset: This allows users to reset application specific settings to default settings.

1. With the indicator powered up and in normal operating mode, press and hold **F1** ...
Pass is now displayed, prompting the user to enter the password.
2. Key in the Supervisor Password (1793) and press  ...
SuPEr is now displayed.
3. Press  ...
SETPNT is now displayed.
4. Press  until...
CHECK is now displayed





Outputs

Check ↓ Outputs

5. From **chEcK**, press  ...
outPutS is displayed. There are two choices for outputs, LAtch and unLAtch (default).
6. Press  ...
The current choice is displayed.
7. Press  or  to toggle between the choices and press  to select an option...
outPutS is displayed.

Under Segment Divisions

Check ↓ Outputs → Under divisions

8. From **outPutS** press  ...
USEGdIV is now displayed.
9. Press  ...
The current value is shown with a flashing right-most digit.
10. Press  to accept the current value or key in a new value and press  to accept...
USEGdIV is now displayed.

Over Segment Divisions

Check ↓ Outputs → Under divisions → Over divisions

11. From **USEGdiv** press ► ...
OSEGdIV is now displayed.
12. Press ▼ ...
The current value is shown with a flashing right-most digit.
13. Press ◀ to accept the current value or key in a new value and press ◀ to accept...
OSEGdIV is now displayed.

Backlight Mode

Check ↓ Outputs → Under divisions → Over divisions → Backlight Mode

14. From **OSEGdIV**, press ► ...
bckModE is now displayed
15. Press ▼ ...
NEAr ZEr is now displayed
16. Press ▼ ...
yEllow is now displayed
17. To change the Backlight Color, use ◀ or ► to toggle through the options and press ◀ to make a selection...
NEAr ZEr is now displayed
18. Press ► ...
UNdEr is now displayed
19. Press ▼ ...
REd is now displayed
20. To change the Backlight Color, use ◀ or ► to toggle through the options and press ◀ to make a selection...
UNdEr is now displayed
21. Press ► ...
AccePt is now displayed
22. Press ▼ ...
GrEEN is now displayed
23. To change the Backlight Color, use ◀ or ► to toggle through the options and press ◀ to make a selection...
AccePt is now displayed
24. Press ► ...
OvEr is now displayed
25. Press ▼ ...
OrANgE is now displayed
26. To change the Backlight Color, use ◀ or ► to toggle through the options and press ◀ to make a selection...
OvEr is now displayed
27. Press ▲ ...
bckModE is displayed

Reset

Check ↓ **Outputs** → **Under divisions** → **Over divisions** → **Backlight Mode**

→ **Reset**

28. From **bcKModE**, press ► ...
RESEt is now displayed. Use this to reset the all the checkweigher variables to the factory defaults.
29. Press ▼ ...
No is now displayed.
30. Press **F1** to abort the reset or press ► ...
YES is now displayed.
31. Press ↵ to reset the settings to factory defaults...
buSy is briefly displayed, then **RESEt** is now displayed.
32. Press ▲ ...
CHECK is now displayed.

8.6.1 Checkweighing Mid Supervisor Menu Setup

Outputs: This controls the behavior of the relay controlling any peripheral device connected to the ZM223.

Unlatch: This means that the relay and annunciator will change instantly as the weight swings above and below the output value.

Latch: This means that weights will have to stabilize at or above the output value before the relay or annunciator changes.

Under Seg Div: This controls the value each segment of Under bar graph annunciator represents. When set to 0.05 lbs, each Under bar graph annunciator segment represents 0.05 lbs.

Over Seg Div: This controls the value each segment of Over bar graph annunciator represents. When set to 0.05 lbs, each Over bar graph annunciator segment represents 0.05 lbs.

Print Total: Enables or disables the ability to print totals. Totals are printed automatically at the end of a packrun or at any time by pressing and holding the **PRINT** key.

Total Print Format: This allows users to choose a Print Format by entering the corresponding Print Format Number. To see a complete list of available Print Formats go to [page 209](#).

Clear Total: When enabled, this allows users to clear a Transaction at the end of an accumulation by pressing and holding the **PRINT** key. The Transaction Totals will be printed followed by clearing the Transaction Totals for that Accumulator Channel. The display will flash **PRN-TOT**. When disabled, the only way to clear a Transaction is through the Supervisor Menu by using the Reset function.

Digits: This controls if the indicator's display digits are on or off. When off, the display will only change color to signal under, over, or at target.

Graph: This controls if the indicator's display bar graph is on or off. If turned off, it also disables the backlight from changing with outputs.

Stats: This controls which statistical model the application uses to generate graphs. The ZM223 supports Standard Deviation and X-Bar/R Charts.

Type: This controls how checkweighing targets are captured. The options are **SAMPLE** (default) to **LIMITS**. Sample means the Target Weight, and High and Low Accept Windows are acquired by using a sample weight. Limits means the user enters upper and lower weight limits to establish the acceptable weight range.

A-Tare: This controls if the Automatic Tare function is on or off. This is mainly used when negative checkweighing.

BckMode: This allows users to select the Back Light Color for the Near Zero, Under, Accept, and Over settings.

Reset: This allows users to reset application specific settings to default settings.

1. With the indicator powered up and in normal operating mode, press and hold **F1**
...
Pass is now displayed, prompting the technician or user to enter the password.
2. Key in the Supervisor Password (1793) and press  ...
SuPEr is now displayed.

3. Press **▶** until...
CHECK is now displayed. This stands for checkweigher. Use this to set the items relating to checkweighing:
 - Set under divisions for acceptable target weight (**USEGdIV**)
 - Set over divisions for acceptable target weight (**OSEGdIV**)
 - Turns on print total (**Prt TOT**)
 - Selects print total format (**ToT Fmt**)
 - Turns on clear total (**CLR TOT**)
 - Turns off Weight digits (**digitS**)
 - Turns off bar graph (**GrAPH**)
 - Turns on Stats (**STATS**)
 - Select the type of checkweighing window (**TYPE**)
 - Turns on Auto Tare (**A-TARE**)
 - Changes the backlight colors used in Under, Over, and Accept (**bckModE**)
 - Reset the target values to zero (**RESEt**)

Outputs - Latch & Unlatch

Check ↓ Outputs ↓ Latch & Unlatch

4. From **CHECK** press **▼** ...
OUTPUTS is now displayed.
5. Press **▼** ...
UNLATCH is now displayed.
6. Press **◀** or **▶** to toggle between the options (**LATCH** and **UNLATCH**) and press **↵** select an option...
OUTPUTS is now displayed.



Note: If the checkweigh mode is currently using the LO and HI limit values, viewing or entering the Under or Over division settings will change these Limit values accordingly.

Under Segment Divisions

Check ↓ Outputs → Under Divisions

7. From **OUTPUTS** press **▶** ...
USEdIV is now displayed.
8. Press **▼** ...
The current value is shown with a flashing right-most digit.
9. Press **↵** to accept the current value or key in a new value and press **↵** to accept...
USEdIV is now displayed.

Over Segment Divisions

Check ↓ Outputs → Under divisions → Over Divisions

10. From **USEdIV** press **▶** ...
OSEGdIV is now displayed.
11. Press **▼** ...
The current value is shown with a flashing right-most digit.
12. Press **↵** to accept the current value or key in a new value and press **↵** to accept...
OSEGdIV is now displayed.

Print Total

Check ↓ Outputs → Under divisions → Over divisions → Print Total

13. From **OSEGdIV** press **▶** ...
Prt TOT is now displayed. Use this to enable/disable printing of the Total report. Choose **ON** (default) to enable and **OFF** to disable this function.
14. Press **▼** ...
The current choice is displayed.
15. Press **◀** or **▶** to toggle between the choices and when your choice is displayed, press **↵** to accept...
Prt TOT is displayed.

Total Format

Check ↓ Outputs → Under divisions → Over divisions → Print Total → Total Format

To print the Total Format for the ZM223 Mid-Level Checkweighing application you must either perform a reset shown below (see [page 163](#)), which sets the Total format to 9 or manually key in 9 under the Total Format menu item.

17. From **Prt TOT** Press **▶** ...
ToT FmT is now displayed. Use this to choose a print format for the Total report.
18. Press **▼** ...
The current print format number is displayed.
19. Press **↵** to accept this or key in a new print format number and press **↵** to accept...
ToT FmT is displayed.

Clear Total

Check ↓ Outputs → Under divisions → Over divisions → Print Total → Total Format → Clear Total

20. From **ToT FmT** Press **▶** ...
CLR TOT is displayed. Use this to enable or disable the clearing of the transaction counter. Choose **ON** (default) to enable and **OFF** to disable the clearing of the transaction counter.
21. Press **▼** ...
The current choice is displayed.
22. Press **◀** or **▶** to toggle between the choices and press **↵** to select an option...
CLR TOT is displayed.

Digits

Check ↓ Outputs → Under divisions → Over divisions → Print Total → Total Format → Clear Total → Digits

23. From **CLR TOT** press **▶** ...
digitS is now displayed. Use this to enable or disable the clearing of the transaction counter. Choose **ON** (default) to enable and **OFF** to disable the clearing of the transaction counter.
24. Press **▼** ...
The current choice is displayed.
25. Press **◀** or **▶** to toggle between the choices and press **↵** to select an option...
digitS is displayed.

Graph

Check ↓ **Outputs** → **Under divisions** → **Over divisions** → **Print Total** → **Total Format** → **Clear Total** → **Digits** → **Graph**

26. From **digitS** press ► ...
GrAPh is displayed. Use this to enable or disable the clearing of the transaction counter. Choose **ON** (default) to enable and **OFF** to disable the clearing of the transaction counter.
27. Press ▼ ...
The current choice is displayed.
28. Press ◀ or ▶ to toggle between the choices and press ↵ to select an option...
GrAPh is displayed.

Stats

Check ↓ **Outputs** → **Under divisions** → **Over divisions** → **Print Total** → **Total Format** → **Clear Total** → **Digits** → **Graph** → **Stats**

29. From **GrAPh**, press ► ...
STATS is now displayed.
30. Press ▼ ...
OFF is now displayed.
31. Use ◀ or ▶ to toggle between the choices (**OFF**, **Std dEV**, **X-bAR**) and press ↵ to select an option...
STATS is now displayed.

Type

Check ↓ **Outputs** → **Under divisions** → **Over divisions** → **Print Total** → **Total Format** → **Clear Total** → **Digits** → **Graph** → **Stats** → **Packrun** → **Type**

32. From **STATS** press ► ...
TYPE is now displayed. Use this to choose which type of checkweighing you want to do: **SAMPLE** or **LIMITS**. Select **SAMPLE** mode (default) if you want to enter a target weight by placing a sample on the scale and pressing the **TARGET** key. The upper tolerance is automatically set to +1 division and the lower tolerance is automatically set to -1 division. The **Tol Hi** and **Tol Low** work from this target point. Select **LiMitS** mode to enter an upper and lower limit which defines the acceptable weight range.
33. Press ▼ ...
The current choice is displayed.
34. Press ◀ or ▶ to toggle between the choices and press ↵ to select an option...
TYPE is displayed.

Auto Tare

Check ↓ **Outputs** → **Under divisions** → **Over divisions** → **Print Total** → **Total Format** → **Clear Total** → **Digits** → **Graph** → **Stats** → **Type** → **Auto Tare**

35. From **TYPE** press ► ...
A-TARE is displayed. Use this to disable or enable (**OFF** (default) or on) an auto tare when the target weight is reached. This allows you to add items to a box or pallet and auto-tare the weight of each item if it falls in the target range.
36. Press ▼ ...
The current choice is displayed.

37. Press ◀ or ▶ to toggle between the choices and press ↵ to select an option...

A-tArE is displayed.





Backlight Mode

Check ↓ Outputs → Under divisions → Over divisions → Print Total → Total Format → Clear Total → Digits → Graph → Stats → Type → Auto Tare → Backlight Mode

38. From **A-TARE**, press ▶ ...
bcKModE is now displayed
39. Press ▼ ...
NEAr ZEr is now displayed
40. Press ▼ ...
yEllow is now displayed
41. To change the Backlight Color, use ◀ or ▶ to toggle through the options and press ↵ to make a selection...
NEAr ZEr is now displayed
42. Press ▶ ...
UNdEr is now displayed
43. Press ▼ ...
REd is now displayed
44. To change the Backlight Color, use ◀ or ▶ to toggle through the options and press ↵ to make a selection...
UNdEr is now displayed
45. Press ▶ ...
AccePt is now displayed
46. Press ▼ ...
GrEEN is now displayed
47. To change the Backlight Color, use ◀ or ▶ to toggle through the options and press ↵ to make a selection...
AccePt is now displayed
48. Press ▶ ...
OvEr is now displayed
49. Press ▼ ...
OrANgE is now displayed
50. To change the Backlight Color, use ◀ or ▶ to toggle through the options and press ↵ to make a selection...
OvEr is now displayed
51. Press ▲ until **bcKModE** is displayed.

Reset

Check ↓ Outputs → Under divisions → Over divisions → Print Total → Total
Format → Clear Total → Digits → Graph → Stats → Type → Auto Tare → Backlight
Mode → Reset

52. From **A-TARE** press  ...
RESEt is displayed. Use this to reset the factory defaults for the
checkweighing parameters.
53. Press  ...
No is displayed.
54. Press  to abort the reset or, to reset the defaults, press **UNITS...**
YES is displayed. Accepting this will reset the defaults.
55. Press  to accept...
RESEt is now displayed.

8.7.1 Checkweighing Advanced-Level Supervisor Menu Setup

Super ↓ Setpoint → Tare → Check

Outputs: This controls the behavior of the relay controlling any peripheral device connected to the ZM223.

Unlatch: This means that the relay and annunciator will change instantly as the weight swings above and below the output value.

Latch: This means that weights will have to stabilize at or above the output value before the relay or annunciator changes.

Under Seg Div: This controls the value each segment of Under bar graph annunciator represents. When set to 0.05 lbs, each Under bar graph annunciator segment represents 0.05 lbs.

Over Seg Div: This controls the value each segment of Over bar graph annunciator represents. When set to 0.05 lbs, each Over bar graph annunciator segment represents 0.05 lbs.

Print Total: Enables or disables the ability to print totals. Totals are printed automatically at the end of a packrun or at any time by pressing and holding the **PRINT** key.

Total Print Format: This allows users to choose a Print Format by entering the corresponding Print Format Number. To see a complete list of available Print Formats go to [page 209](#).

Clear Total: When enabled, this allows users to clear a Transaction at the end of an accumulation by pressing and holding the **PRINT** key. The Transaction Totals will be printed followed by clearing the Transaction Totals for that Accumulator Channel. The display will flash **PRN-TOT**. When disabled, the only way to clear a Transaction is through the Supervisor Menu by using the Reset function.

Digits: This controls if the indicator's display digits are on or off. When off, the display will only change color to signal under, over, or at target.

Graph: This controls if the indicator's display bar graph is on or off. If turned off, it also disables the backlight from changing with outputs.

Stats: This controls the statistical model the application uses to provide summary data. The ZM223 supports Standard Deviation and X-Bar/R Charts.

Packrun: Set the number of pieces that must be weighed to make up a complete packrun. This also sets the quantity needed for Standard Deviation and X bar/R functionality.

Type: This controls how the indicator acquires the Target Weight. Choose between **SAMPLE** or **LIMITS**.

A-tare: This controls if the Automatic Tare function is on or off.

Back Light Mode: This allows users to select the Back Light Color for the Near Zero, Under, Accept, and Over settings.

Reset: This allows users to reset application specific settings to default settings.

1. With the indicator powered up and in normal operating mode, press and hold **F1**
...
PASS is now displayed, prompting the user to enter the password.
2. Key in the Supervisor Password (1793) and press  ...
SUPER is now displayed.

3. Press ▼ ...
SETPNT is now displayed.
4. Press ► until...
CHECK is now displayed. This stands for checkweigher. Use this to set the items relating to checkweighing:
 - Set under divisions for acceptable target weight (**USEGdIV**)
 - Set over divisions for acceptable target weight (**OSEGdIV**)
 - Turns on print total (**Prt TOT**)
 - Selects print total format (**ToT FMT**)
 - Turns on clear total (**CLR TOT**)
 - Turns off Weight digits (**digitS**)
 - Turns off bar graph (**GrAPh**)
 - Turns on Stats (**STATS**)
 - Select the type of checkweighing window (**TYPE**)
 - Set Packrun quantities (**PACKRUN**)
 - Turns on Auto Tare (**A-TARE**)
 - Changes the Backlight colors used in Under, Over, and Accept (**bcKModE**)
 - Reset the target values to zero (**RESEt**)

Outputs - Latch & Unlatch

Check ↓ Outputs ↓ Latch & Unlatch

5. From **CHECK** press ▼ ...
OUTPUTS is now displayed. There are
6. Press ▼ ...
UNLATCH is now displayed.
7. Press ◀ or ▶ to toggle between the options (**LATCH** and **UNLATCH**) and press ↵ select an option...
OUTPUTS is now displayed.



Note: If the checkweigh mode is currently using the LO and HI limit values, viewing or entering the Under or Over division settings will change these Limit values accordingly.

Under Segment Divisions

Check ↓ Outputs → Under Divisions

8. From **OUTPUTS** press ► ...
USEGdIV is now displayed.
9. Press ▼ ...
The current value is shown with a flashing right-most digit.
10. Press ↵ to accept the current value or key in a new value and press ↵ to accept...
USEGdIV is now displayed.

Over Segment Divisions

Check ↓ Outputs → Under Divisions → Over Divisions

11. From **USEGdIV** press ► ...
OSEGdIV is now displayed.
12. Press ▼ ...
The current value is shown with a flashing right-most digit.
13. Press ↵ to accept the current value or key in a new value and press ↵ to accept...
OSEGdIV is now displayed.

Print Total

Check ↓ Outputs → Under Divisions → Over Divisions → Print Total

14. From **OSEGdIV** press ► ...
Prt TOT is now displayed. Use this to enable/disable printing of the Total report. Choose on (default) to enable and oFF to disable this function.
15. Press ▼ ...
The current choice is displayed.
16. Press ◀ or ▶ to toggle between the choices and when your choice is displayed, press ↵ to accept...
Prt TOT is displayed.

Total Format

Check ↓ Outputs → Under Divisions → Over Divisions → Print Total → Total Format

To print the Total Format for the ZM223 Mid-Level Checkweighing application you must either perform a reset shown below (see [page 163](#)), which sets the Total Format to 9 or manually key in 9 under the Total Format menu item.

17. From **Prt TOT** Press ► ...
ToT FMt is now displayed. Use this to choose a print format for the Total report.
18. Press ▼ ...
The current print format number is displayed.
19. Press ↵ to accept this or key in a new print format number and press ◀ to accept...
ToT FMt is displayed.

Clear Total

Check ↓ Outputs → Under Divisions → Over Divisions → Print Total → Total Format → Clear Total

20. From **ToT FMt**, press ► ...
CLR TOT is displayed. Use this to enable or disable the clearing of the transaction counter. Choose **ON** (default) to enable and **OFF** to disable the clearing of the transaction counter.
21. Press ▼ ...
The current choice is displayed.
22. Press ◀ or ▶ to toggle between the choices and press ↵ to select an option...
CLR TOT is displayed.





Digits

Check ↓ Outputs → Under Divisions → Over Divisions → Print Total → Total Format → Clear Total → Digits

23. From **CLR TOT** press ► ...
digitS is now displayed. Use this to turn the weight display **OFF** or **ON** (default) when in checkweighing mode. When set to **OFF** the bar graph is the only part of the display that is on.
24. Press ▼ ...
The current choice is displayed.
25. Press ◀ or ▶ to toggle between the choices and press ↵ to select an option...
digitS is displayed.





Graph

Check ↓ Outputs → Under Divisions → Over Divisions → Print Total → Total
Format → Clear Total → Digits → Graph

26. From **digitS** press  ...
GrAPh is displayed. Use this to turn the weight display **OFF** or **ON** (default) when in checkweighing mode. When set to **OFF** the bar graph is the only part of the display that is on.
27. Press  ...
The current choice is displayed.
28. Press  or  to toggle between the choices and press  to select an option...
GrAPh is displayed.



Stats

Check ↓ Outputs → Under Divisions → Over Divisions → Print Total → Total
Format → Clear Total → Digits → Graph → Stats

29. From **GrAPh**, press  ...
STATS is now displayed.
30. Press  ...
OFF is now displayed.
31. Use  or  to toggle between the choices (**OFF**, **Std dEV**, and **X-bAR**) and press  to select an option...
STATS is now displayed.





Packrun

Check ↓ Outputs → Under Divisions → Over Divisions → Print Total → Total
Format → Clear Total → Digits → Graph → Stats → Packrun

32. From **STATS**, press  ...
PACKRUN is now displayed.
33. Press  ...
0 is now displayed.
34. Key in the desired packrun size and press  ...
PACKRUN is now displayed.

Type

Check ↓ Outputs → Under Divisions → Over Divisions → Total Format → Clear
Total → Digits → Graph → Stats → Packrun → Type

35. From **PACKRUN** press  ...
TYPE is now displayed. Use this to choose which type of checkweighing you want to do: **SAMPLE** or **LIMITS**. Select **SAMPLE** mode (default) if you want to enter a target weight by placing a sample on the scale and pressing the **TARGET** key. The upper tolerance is automatically set to +1 division and the lower tolerance is automatically set to -1 division. The Tol Hi and Tol Low work from this target point. Select **LiMitS** mode to enter an upper and lower limit which defines the acceptable weight range.
36. Press  ...
The current choice is displayed.
37. Press  or  to toggle between the choices and press  to select an option...
TYPE is displayed.

Auto Tare

Check ↓ Outputs → Under Divisions → Over Divisions → Print Total → Total
Format → Clear Total → Digits → Graph → Stats → Packrun → Type → Auto Tare

38. From **TYPE** press ► ...
A-TARE is displayed. Use this to disable or enable (**OFF** (default) or on) an auto tare when the target weight is reached. This allows you to add items to a box or pallet and auto-tare the weight of each item if it falls in the target range.
39. Press ▼ ...
The current choice is displayed.
40. Press ◀ or ▶ to toggle between the choices and press ↵ to select an option...
A-TARE is displayed.

Backlight Mode

Check ↓ Outputs → Under Divisions → Over Divisions → Print Total → Total
Format → Clear Total → Digits → Graph → Stats → Packrun → Type → Auto Tare
→ Backlight Mode

41. From **A-TARE**, press ► ...
bcKModE is now displayed
42. Press ▼ ...
NEAr ZEr is now displayed
43. Press ▼ ...
yEllow is now displayed
44. To change the Backlight Color, use ◀ or ▶ to toggle through the options and press ↵ to make a selection...
NEAr ZEr is now displayed
45. Press ► ...
UNdEr is now displayed
46. Press ▼ ...
REd is now displayed
47. To change the Backlight Color, use ◀ or ▶ to toggle through the options and press ↵ to make a selection...
UNdEr is now displayed
48. Press ► ...
AccePt is now displayed
49. Press ▼ ...
GrEEN is now displayed
50. To change the Backlight Color, use ◀ or ▶ to toggle through the options and press ↵ to make a selection...
AccePt is now displayed
51. Press ► ...
OvEr is now displayed
52. Press ▼ ...
OrANGe is now displayed

53. To change the Backlight Color, use ◀ or ▶ to toggle through the options and press ↵ to make a selection...

Over is now displayed

54. Press ▲ until **bcKModE** is displayed.

Reset

**Check ↓ Outputs → Under Divisions → Over Divisions → Print Total → Total
Format → Clear Total → Digits → Graph → Stats → Packrun → Type → Auto Tare
→ Backlight Mode → Reset**

55. From **bcKModE**, press ▶ ...

RESET is displayed. Use this to reset the factory defaults for the checkweighing parameters.

56. Press ▼ ...

No is displayed. This is the default value.

57. Press ↵ to abort the reset or, to reset the defaults, press UNITS...

YES is displayed. Accepting this will reset the defaults.

58. Press ↵ to accept...

RESEt is now displayed.

8.8.1 Checkweighing by Percentage Supervisor Menu Setup

Outputs: This allows users determine when the relay or annunciator changes once a weight is above or below the output value.

Latch: Weights will stabilize at or above the output value before the relay or annunciator changes.

Unlatch: The relay and annunciator will change instantly as the weight swings above or below the output value.

Under Seg Div: This controls the value each segment of Under bar graph annunciator represents. When set to 10%, each Under bar graph annunciator segment represents 10%.

Over Seg Div: This controls the value each segment of Over bar graph annunciator represents. When set to 10%, each Over bar graph annunciator segment represents 10%.

Low Tolerance: This controls the active Low Tolerance %.

High Tolerance: This controls the active High Tolerance %.

Print Total: This allows users to print the Total Printing print format by holding down the **PRINT** key. This prints an accumulated total for the day, shift, etc., rather than the current value of the current run.

Total Print Format: This allows users to choose a Print Format by entering the corresponding Print Format Number. To see a complete list of available Print Formats go to [page 209](#).

Clear Total: When enabled, this allows users to clear a Transaction at the end of an accumulation by pressing and holding the **PRINT** key. The Transaction Totals will be printed followed by clearing the Transaction Totals for that Accumulator Channel. The display will flash **PRN-TOT**. When disabled, the only way to clear a Transaction is through the Supervisor Menu by using the Reset function.

Digits: This controls if the indicator's display digits are on or off. When off, the display will only change color to signal under, over, or at target.



Graph: This controls if the indicator's display bar graph is on or off. If turned off, it also disables the backlight from changing with outputs.

Stats: This controls which statistical model the application uses to generate graphs. The ZM223 supports Standard Deviation and X-Bar/R Charts.

Type: This controls how the indicator acquires the Target Weight. Choose between **SAMPLE** or **LIMITS**.

Back Light Mode: This allows users to select the Back Light Color for the Near Zero, Under, Accept, and Over settings.

Reset: This allows users to reset application specific settings to default settings.

1. With the indicator powered up and in normal operating mode, press and hold **F1** ...
Pass is now displayed, prompting the technician or user to enter the password.
2. Key in the Supervisor Password (1793) and press  ...
SUPER is now displayed.
3. Press  ...
SETPNT is now displayed.

4. Press **▶** until...
CHECK is now displayed. This stands for checkweigher. Use this to set the items relating to checkweighing:
 - Set conditions for using the outputs (**OUTPUTS**)
 - Set under divisions for acceptable target weight (**USEGdIV**)
 - Set over divisions for acceptable target weight (**OSEGdIV**)
 - Reset the target values to zero (**RESET**)

Outputs - Latch & Unlatch

Check ↓ Outputs ↓ Latch & Unlatch

5. From **CHECK** press **▼** ...
OUTPUTS is now displayed. There are
6. Press **▼** ...
UNLATCH is now displayed.
7. Press **◀** or **▶** to toggle between the options (**LA**tch and **UnLA**tch) and press **↵** select an option...
OUTPUTS is now displayed.



Note: If the checkweigh mode is currently using the LO and HI limit values, viewing or entering the Under or Over division settings will change these Limit values accordingly.

Under Segment Divisions

Check ↓ Outputs → Under divisions

8. From **OUTPUTS**, press **▶** ...
USEGdIV is now displayed.
9. Press **▼** ...
The current value is shown with a flashing right-most digit.
10. Press **↵** to accept the current value or key in a new value and press **↵** to accept...
USEGdIV is now displayed.

Over Segment Divisions

Check ↓ Outputs → Under divisions → Over divisions

11. From **USEGdIV**, press **▶** ...
OSEGdIV is now displayed.
12. Press **▼** ...
The current value is shown with a flashing right-most digit.
13. Press **↵** to accept the current value or key in a new value and press **↵** to accept...
OSEGdIV is now displayed.

Print Total

Check ↓ Outputs → Under divisions → Over divisions → Print Total

14. From **OSEGdIV** press **▶** ...
Prt TOT is now displayed. Use this to enable/disable printing of the Total report. Choose **ON** to enable and **OFF** (default) to disable this function.
15. Press **▼** ...
The current choice is displayed.
16. Press **◀** or **▶** to toggle between the choices and when your choice is displayed, press **↵** to accept...
Prt TOT is displayed.

Total Format

Check ↓ Outputs → Under divisions → Over divisions → Print Total → Total Format

To print the Total Format for the ZM223 Mid-level Checkweighing application you must either perform a reset shown below, which sets the Total Format to 9 or manually key in 9 under the Total Format menu item.

17. From **Prt TOT** Press **▶** ...
ToT FmT is now displayed. Use this to choose a print format for the Total report.
18. Press **▼** ...
The current print format number is displayed.
19. Press **◀** to accept this or key in a new print format number and press **◀** to accept ...
ToT FmT is displayed.

Clear Total

Check ↓ Outputs → Under divisions → Over divisions → Print Total → Total Format → Clear Total

20. From **ToT FmT** Press **▶** ...
CLR TOT is displayed. Use this to enable or disable the clearing of the transaction counter. Choose **ON** (default) to enable and **OFF** to disable the clearing of the transaction counter.
21. Press **▼** ...
The current choice is displayed.
22. Press **◀** or **▶** to toggle between the choices and press **◀** to select an option...
CLR TOT is displayed.

Digits

Check ↓ Outputs → Under divisions → Over divisions → Print Total → Total Format → Clear Total → Digits

23. From **CLR TOT** press **▶** ...
digitS is now displayed. Use this to turn the weight display off or on (default) when in checkweighing mode. When set to off the bar graph is the only part of the display that is on.
24. Press **▼** ...
The current choice is displayed.
25. Press **◀** or **▶** to toggle between the choices and press **◀** to select an option...
digitS is displayed.





Graph

Check ↓ Outputs → Under divisions → Over divisions → Print Total → Total Format → Clear Total → Digits → Graph

26. From **digitS** press **▶** ...
GrAPh is displayed. Use this to turn the graph display off or on (default) when in checkweighing mode. When set to off the weight digits are the only part of the display that is on.
27. Press **▼** ...
The current choice is displayed.
28. Press **◀** or **▶** to toggle between the choices and press **◀** to select an option...
GrAPh is displayed.





Stats

Check ↓ Outputs → Under divisions → Over divisions → Print Total → Total Format
→ Clear Total → Digits → Graph → Stats

29. From **GrAPh**, press  ...
STATS is now displayed.
30. Press  ...
OFF is now displayed.
31. Use  or  to toggle between the choices (**OFF**, **Std dEV** and **X-bAR**) and press  to select an option...
STATS is now displayed.













Type

Check ↓ Outputs → Under divisions → Over divisions → Print Total → Total Format
→ Clear Total → Digits → Graph → Stats → Type

32. From **STATS** press  ...
TYPE is now displayed. Use this to choose which type of checkweighing you want to do: **SAMPLE** or **LiMitS**. Select **SAMPLE** mode (default) if you want to enter a target weight by placing a sample on the scale and pressing the **TARGET** key. The upper tolerance is automatically set to +1 division % and the lower tolerance is automatically set to -1 division %. The **Tol Hi** and **Tol Low** work from this target point. Select **LiMitS** mode to enter an upper and lower limit which defines the acceptable weight range.
33. Press  ...
The current choice is displayed.
34. Press  or  to toggle between the choices and press  to select an option...
TYPE is displayed.

Backlight Mode

Check ↓ Outputs → Under divisions → Over divisions → Print Total → Total Format
→ Clear Total → Digits → Graph → Stats → Type → Backlight Mode

35. From **TYPE**, press  ...
bckModE is now displayed
36. Press  ...
NEAr ZEr is now displayed
37. Press  ...
yEllow is now displayed
38. To change the Backlight Color, use  or  to toggle through the options and press  to make a selection...
NEAr ZEr is now displayed
39. Press  ...
UNdEr is now displayed
40. Press  ...
REd is now displayed
41. To change the Backlight Color, use  or  to toggle through the options and press  to make a selection...
UNdEr is now displayed
42. Press  ...
AccePt is now displayed

43. Press ▼ ...
GrEEN is now displayed
44. To change the Backlight Color, use ◀ or ▶ to toggle through the options and press ↵ to make a selection...
AccEPt is now displayed
45. Press ▶ ...
OvEr is now displayed
46. Press ▼ ...
OrANgE is now displayed
47. To change the Backlight Color, use ◀ or ▶ to toggle through the options and press ↵ to make a selection...
OvEr is now displayed
48. Press ▲ until **bckModE** is displayed

Reset

Check ↓ Outputs → Under divisions → Over divisions → Print Total → Total Format → Clear Total → Digits → Graph → Stats → Type → Backlight Mode → Reset

49. From **bckModE** press ▶ ...
RESEt is displayed. Use this to reset the factory defaults for the checkweighing parameters.
50. Press ▼ ...
No is displayed. This is the default value.
51. Press ↵ to abort the reset or, to reset the defaults, press ▶ ...
YES is displayed. Accepting this will reset the defaults.
52. Press ↵ to accept...
RESEt is now displayed.

8.9 Batching App Supervisor Menu

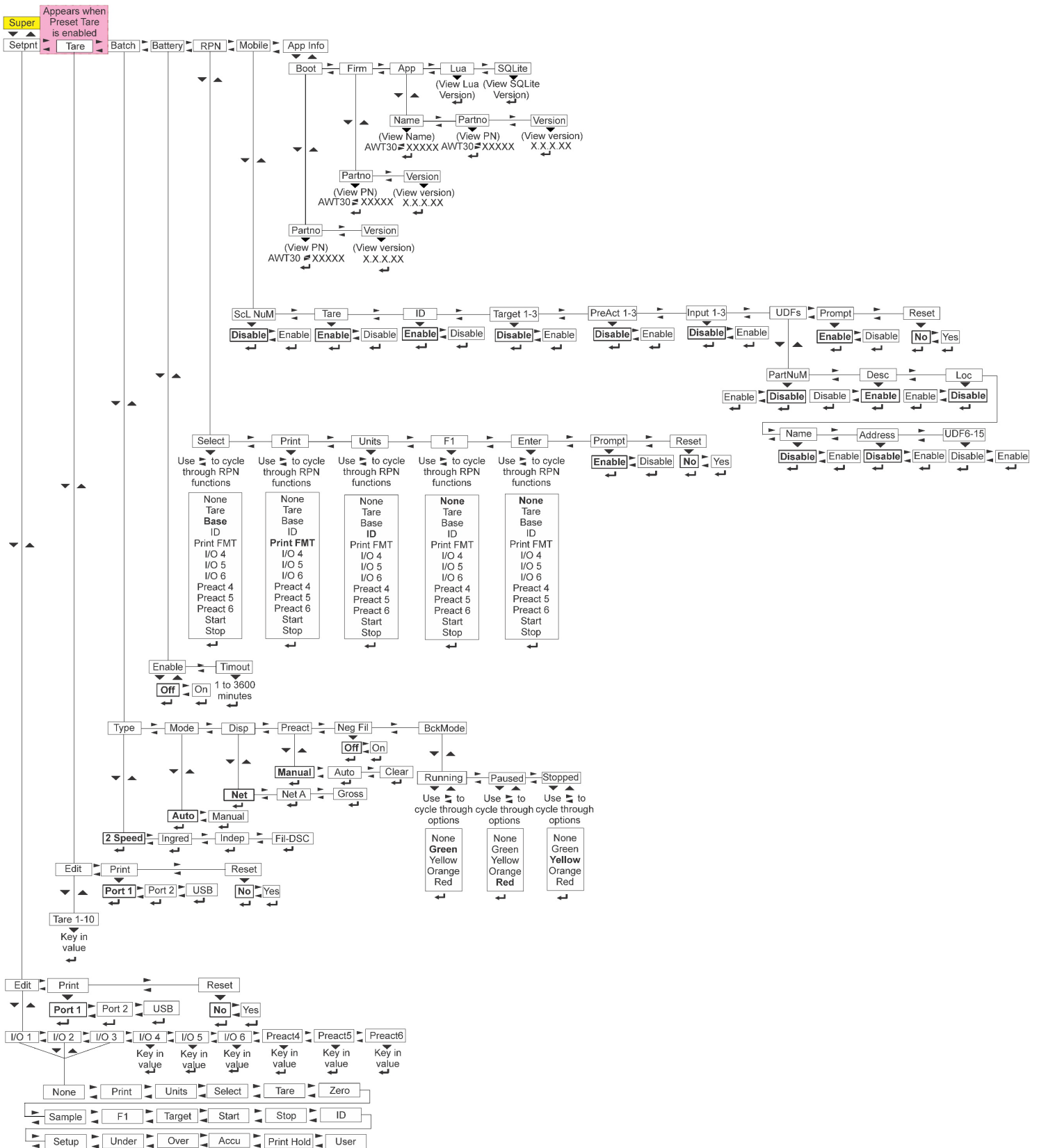

8.9.1 Batching App Supervisor Menu Setup

Type: This allows users to choose between the available filling options: 2 Speed, Ingredients, Independent, and Fill Discharge

Mode: This determines if the indicator is using Manual or Automatic batching.

Manual: When Manual, the preact values entered in the **SETPNT** submenu for **PRACT4**, **PRACT5** and **PRACT6** are used.

Auto: When set to Auto, preact is automatically calculated. The amount of compensation is calculated based on the average variance between the entered setpoint value and the actual fill weights recorded during the most recent batch cycles.

Clear: When **cLEAR** is selected, the current preact values will be set to 0. If **PRACT** was set to **Auto**, a new set of compensation values will be calculated on continuing batches. If preact was set to **Manual**, then preact will be disabled or new values can be manually entered in the setpoint menu.

Display: This allows users to determine if the batching weights are based on Net or Gross values.

Preact: Is used to compensate for product weight that continues to fill into a bag or container after the setpoint output turns off and before the final weight stabilizes.

Neg Fil: Negative filling dispenses a smaller amount of product from a large vessel, tank, or hopper type scale.

Backlight Mode: This controls the behavior of the display's backlight color in relation to the batching settings (Running, Paused, Stopped).

- 1 With the indicator powered up and in normal operating mode, press and hold **F1**

...

PASS is now displayed, prompting the technician or user to enter the password.

- 2 Key in the Supervisor Password (1793) and press  ...

SuPER is now displayed.

- 3 Press  ...

SETPNT is now displayed.

- 4 Press  until...

bATCH is now displayed. Use this to set the items relating to batching:

- Set the type of batch operation (**TYPE**)
- Select auto or manual operation (**MOdE**)
- Set gross or net display mode (**dISP**)
- Set the conditions for preact (**PRACT**)
- Select negative filling operation (**NEG FIL**)
- Set the Backlight Modes (**bckModE**)

Type

Batch ↓ Type

5. From **bATCH** press  ...

TYPE is now displayed. There are 4 choices under Type: **INGRed**, **INdEP**, **FIL-dSC** and **2 SPEEd**. Each is explained below:

INGRed: Choose ingredient for sequential filling for up to 3 products at a single speed.

INdEP: Choose independent when the filling process is run based on the values set for the outputs.

FIL-dSC: Choose fill-discharge when performing a fill operation to a hopper before the dispense process to fill bags or boxes from that hopper by a set weight until the hopper is closer to empty (negative weight) from something like a hopper scale.

2 SPEEd: Choose 2 speed when using a speed control device for one ingredient.

6. Press ▼ ...
The current setting is now displayed.
7. Press ► to scroll through the options and press ◀ to make a selection...
TYPE is now displayed.

Mode

Batch ↓ Type → Mode

8. From **TYPE** press ► ...
ModE is now displayed. Mode has two choices: Auto or MANuAL.
9. Press ▼ ...
The current setting is now displayed.
10. Press ◀ or ► to toggle between the options and press ◀ to make a selection...
ModE is now now displayed.

Display

Batch ↓ Type → Mode → Display

11. From **MOdE** press ► ...
dISP is now displayed. Display has three choices: **NET**, **NET-A** and **GROSS**. Each is explained below:
NET: Choose Net to base batching on net weights.
NET-A: Missing explanation
GROSS: Choose Gross to base batching on gross weights.
12. Press ▼ ...
The current setting is now displayed.
13. Press ◀ or ► to toggle between the options and press ◀ to make a selection...
diSP is now displayed.

Preact

Batch ↓ Type → Mode → Display → Preact

14. From **diSP** press ► ...
PREACT is now displayed.

Preact can be used to compensate for product weight that continues to fill into the bag or container after the setpoint output turns off and before the final weight stabilizes. If a preact value is automatically calculated or manually entered, the actual cutoff weight will equal the entered setpoint value minus the preact value. Preact has three choices: **MANUAL**, **AUTO** or **CLEAR**.

MANUAL: When set to Manual, the preact values entered in the **SETPNT** submenu for **PREACT4**, **5**, and **6** are used.
AUTO: When set to Auto, preact is automatically calculated. The amount of compensation is calculated based on the average variance between the entered setpoint value and the actual fill weights recorded during the

most recent batch cycles. Preact is only available in certain Batch Types as noted in their descriptions. Calculated Preact values can be viewed in the **SETPNT** submenu for **PRACT4**, **5**, and **6**.

CLEAR: When Clear is selected, the current preact values will be set to 0. If **PRACT** was set to Auto, a new set of compensation values will be calculated on continuing batches. If **PRACT** was set to Manual, then preact will be disabled or new values can be manually entered in the Setpoint menu.

15. Press ▼ ...

The current setting is now displayed.

16. Press ► to scroll through the options and press ◀ to make a selection...

PRACT is now displayed.

Negative Fill

Batch ↓ Type → Mode → Display → Preact → Negative Fill

17. From **PRACT** press ▲ ...

NEG FIL is now displayed. This stands for negative fill and has two choices: **ON** or **OFF**. Each is explained below:

Choose **ON** to enable negative fill (default). Operation varies depending on Type chosen.

Choose **OFF** to disable negative fill.

18. Press ▼ ...

The current setting is now displayed.

19. Press ► to scroll through the options and press ◀ to make a selection...

NEG FIL is now displayed.

Backlight Mode

Batch ↓ Type → Mode → Display → Preact → Negative Fill → bcKModE

20. From **NEG FIL**, press ► ...
bcKModE is now displayed

21. Press ▼ ...
RUNNING is now displayed







22. Press ▼ ...
GrEEN is now displayed

23. To change the Backlight Color, use ◀ or ► to toggle through the options and press ◀ to make a selection...
RUNNING is now displayed

24. Press ► ...
PAUSEd is now displayed

25. Press ▼ ...
REd is now displayed

26. To change the Backlight Color, use ◀ or ► to toggle through the options and press ◀ to make a selection...
PAUSEd is now displayed

27. Press  ...
STOPPEd is now displayed
28. Press  ...
yEllow is now displayed
29. To change the Backlight Color, use  or  to toggle through the options and
press  to make a selection...
STOPPEd is now displayed
30. Press  until **bcKModE** is displayed



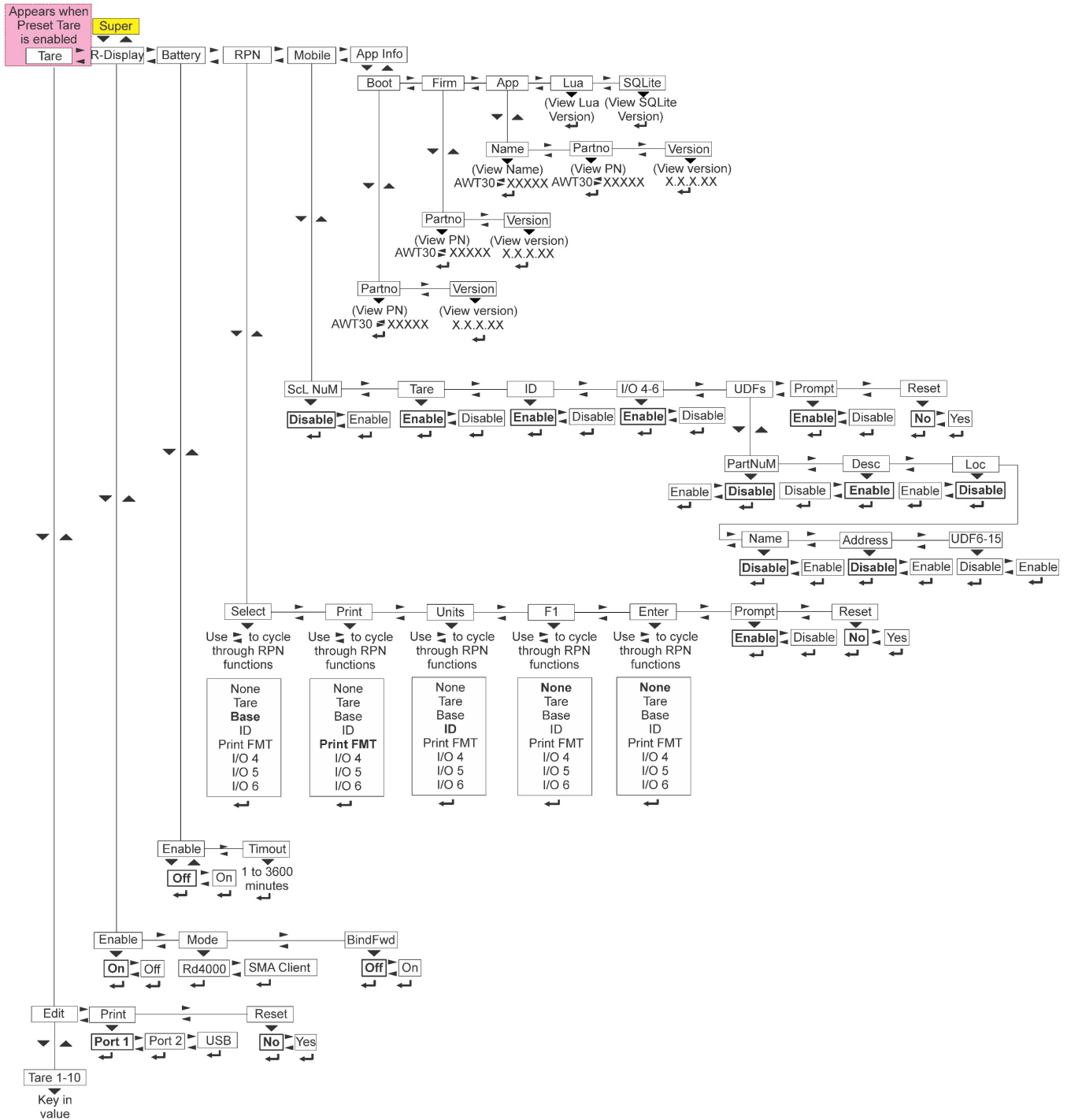













8.10 Remote Display Supervisor Menu



8.10.1 Remote Display App Supervisor Menu Setup

To configure the indicator for remote display operation the user must choose the mode of operation in the Supervisor Menu and configure the port. Configuring the port is done through a password protected menu. Contact a supervisor or the local Avery Weigh-Tronix representative for more information.

Bind Forward: Bind Forward passes a Print Format from the Primary Display Indicator through the Remote Display Indicator. However, this only works if the Print Format starts with a STX character and ends with an ETX character. This allows printing on both the Primary and Remote Displays. The firmware watches the data coming in and if there is a STX it just passes it through until the ETX. This can work using RS232 or Ethernet Connections.

1. With the indicator powered up and in normal operating mode, press and hold **F1** ...
PASS is now displayed, prompting the technician or user to enter the password.
2. Key in the Supervisor Password (1793) and press  ...
SuPEr is now displayed.
3. Press  ...
R-dISP is now displayed.
4. Press  ...
EnAbLE is now displayed. Choices are: **ON** (default) and **OFF**.
5. Press  ...
ON is now displayed.
6. Use  or  to toggle between the options and press  to accept...
EnAbLE is now displayed.
7. Press  ...
ModE is now displayed. Choices are: **Rd4000** and **SMACLNT**.
8. Press  ...
Rd4000 is now displayed.
9. Use  or  to cycle through the options and press  to accept the displayed choice...
ModE is now displayed.
10. Press  ...
biNdFwd is now displayed. Use this to choose which port will be used for printing/communication forwarding from the Primary Indicator. Choices are: **OFF**, **Port 1**, **Port 2**, **ENEt 1-10**.
11. Press  ...
OFF is now displayed.
12. Use  or  to toggle between the choices and press  to accept...
biNdFwd is now displayed.

8.10.2 Remote Display Configuration Using Ztools

We recommend that all users and technicians follow the below steps using Ztools to ensure proper configuration of a Remote Display.



Note: When a Remote Display indicator says OFFLINE it means either there is no signal between it and the Primary Display or print format or communication settings are incorrect.

1. Connect the PC running Ztools to the Primary Display Indicator with an Ethernet Cable.
2. Scan for the Primary Display Indicator and double click on it.
3. Upload from the Primary Indicator

Rd4000 Configuration

Serial Port Connection

Must configure/wire for primary to transmit and Remote Display to receive and grounding. If the keys on the Remote Display need to be operational see the Bind Forwarding section below.

Settings for Primary Display

1. Open whatever application you would like to broadcast the displayed weight with. In this example we will be using the General Application.
2. From the Ztools home screen click on **Serial Port**.

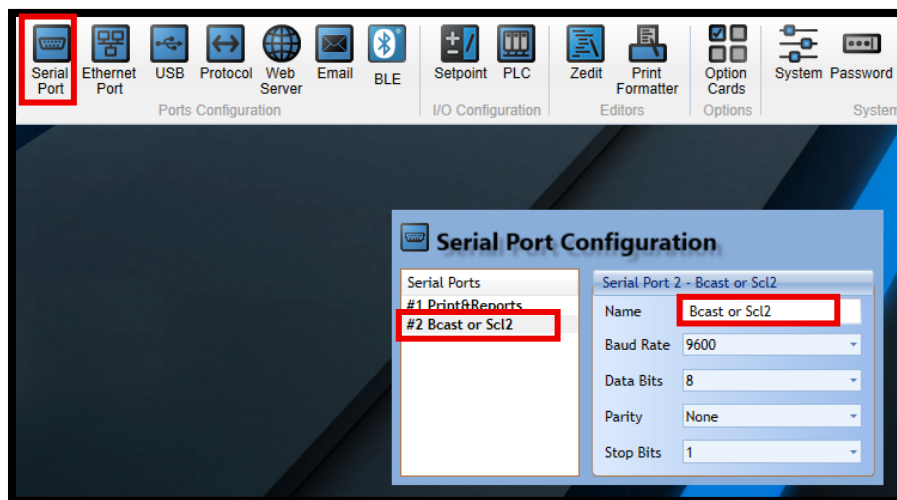

3. Click on the serial port number that the Primary Display Indicator is transmitting to the Remote Display Indicator through. Port 2 in this example.
4. Verify that the Baud Rate (9600 in this example). The Baud Rate must be the same on both Primary and Remote Display Indicators.

5. Click on **Protocol**

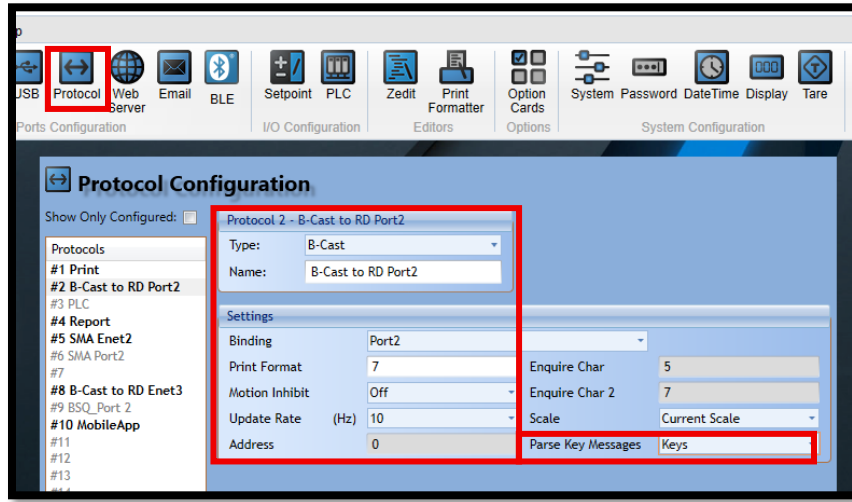

6. Set the Protocol 2 Type to **B-Cast**.
7. Verify that the protocol is set to Print Format #7 or Display Weight.
8. Verify that Parse Key Messages is set to **Keys**. This allows the keys from the Remote Display Indicator to function on the Primary Indicator.
9. Download configuration to the connected indicator.

Settings for Remote Display

10. Ensure that the Remote Display Indicator is running the Remote Display Application.
11. From the Ztools home screen click on **Serial Ports**.

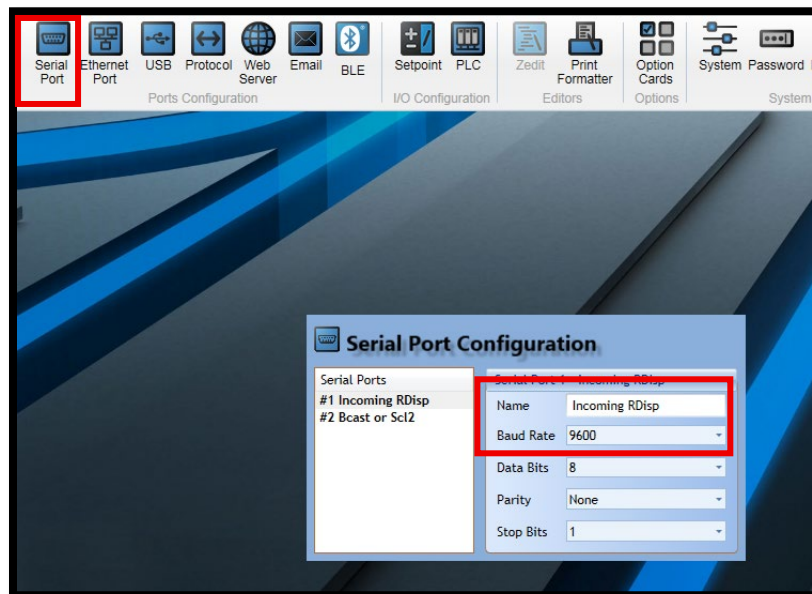

12. Click on the serial port number that the Remote Display Indicator is receiving from the Primary Display Indicator through. Port 1 in this example.
13. Verify that the Baud Rate (9600 in this example). The Baud Rate must be the same on both Primary and Remote Display Indicators.

14. Click on **Protocol**

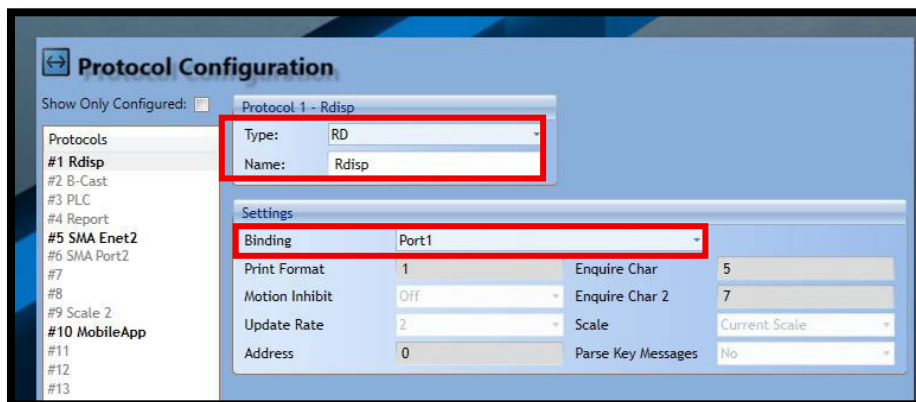

15. The Remote Display App is preconfigured with the RD Protocol on Protocol 1.

16. Verify that the Type is set to **RD** (Remote Display).

17. Ensure that Binding is set to the communication port being used.

18. Download configuration to the connected indicator.

Ethernet Connection

Setting for Primary Display

1. Open whatever application you would like to broadcast the displayed weight with. In this example we will be using the General Application.
2. Click on **Protocol**

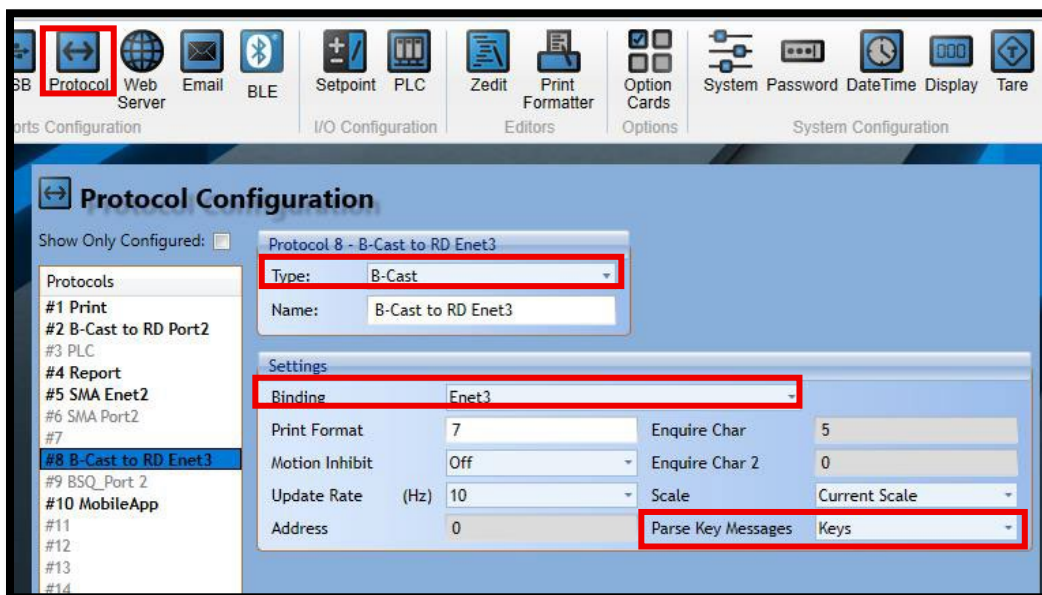

3. Verify that Protocol 8 is set to **B-cast** (Broadcast) and that it is bound it to **Enet 3**

4. Enet 3 is already set up to be a Server to communicate with the Remote Display's to **Enet 1**.

5. Verify that the Protocol is set to Print Format #7 or Display Weight.

6. Verify that Parse Key Messages is set to **Keys**. This allows the keys from the Remote Display Indicator to function on the Primary Indicator.

- Click on **Ethernet Port** to view an example **Enet 3** configuration.

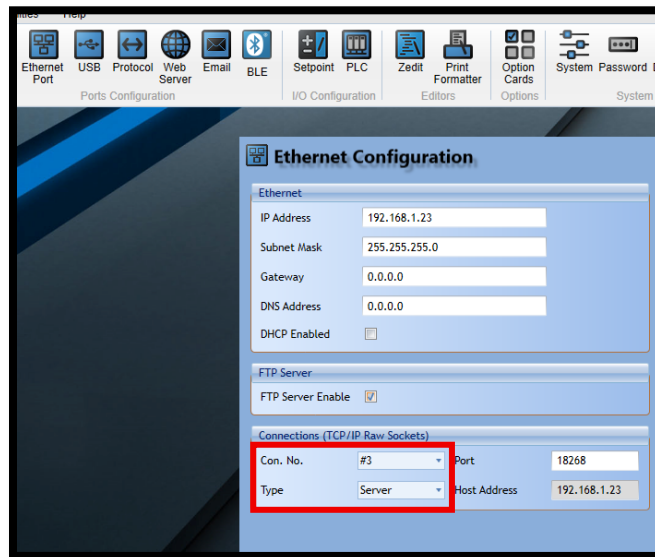

- Download configuration to the connected indicator.

Settings for Remote Display

- Ensure that the Remote Display Indicator is running the Remote Display Application.
- Click on **Protocol**

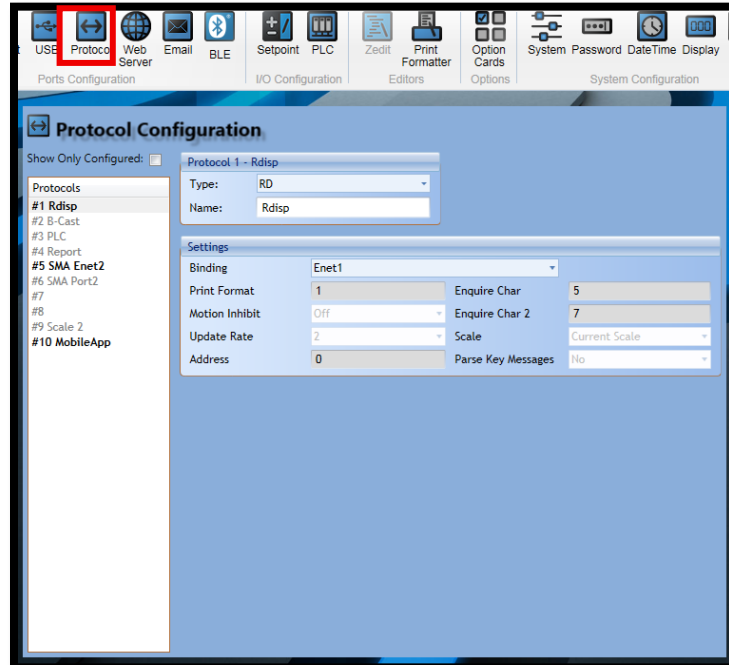

- Verify that the Protocol Type is set to **RD** (remote display) and bound it to **Enet 1**

12. Click on **Ethernet Port**.

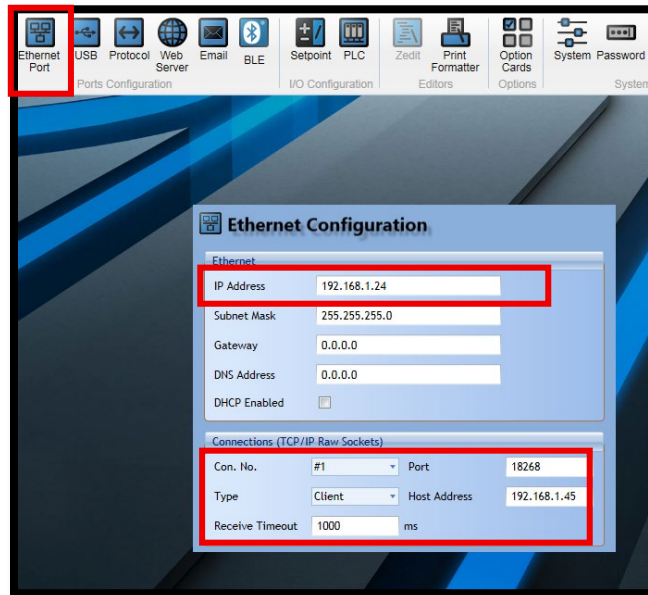

13. Verify that **Enet 1** Configuration matches the example above.
14. Download Configuration to the connected indicator.

SMA Mode

Primary Display

1. Follow the steps above but set Protocol Modes to **SMA** rather than **B-Cast** for the Primary Indicator Configuration.

Protocol 2 = Serial

Protocol 8 = Ethernet



Note: The SMA mode allows our indicators to communicate with any device that uses SMA, whether it is an Avery Weigh-Tronix device or not.

8.10.3 Bind Forward

Bind Forward: Bind Forward passes a Print Format from the Primary Display Indicator through the Remote Display Indicator. However, this only works if the Print Format starts with a STX character and ends with an ETX character. This allows printing on both the Primary and Remote Displays. The firmware watches the data coming in and if there is a STX it just passes it through until the ETX. This can work using RS232 or Ethernet Connections.

8.11 In-Motion App Supervisor Menu

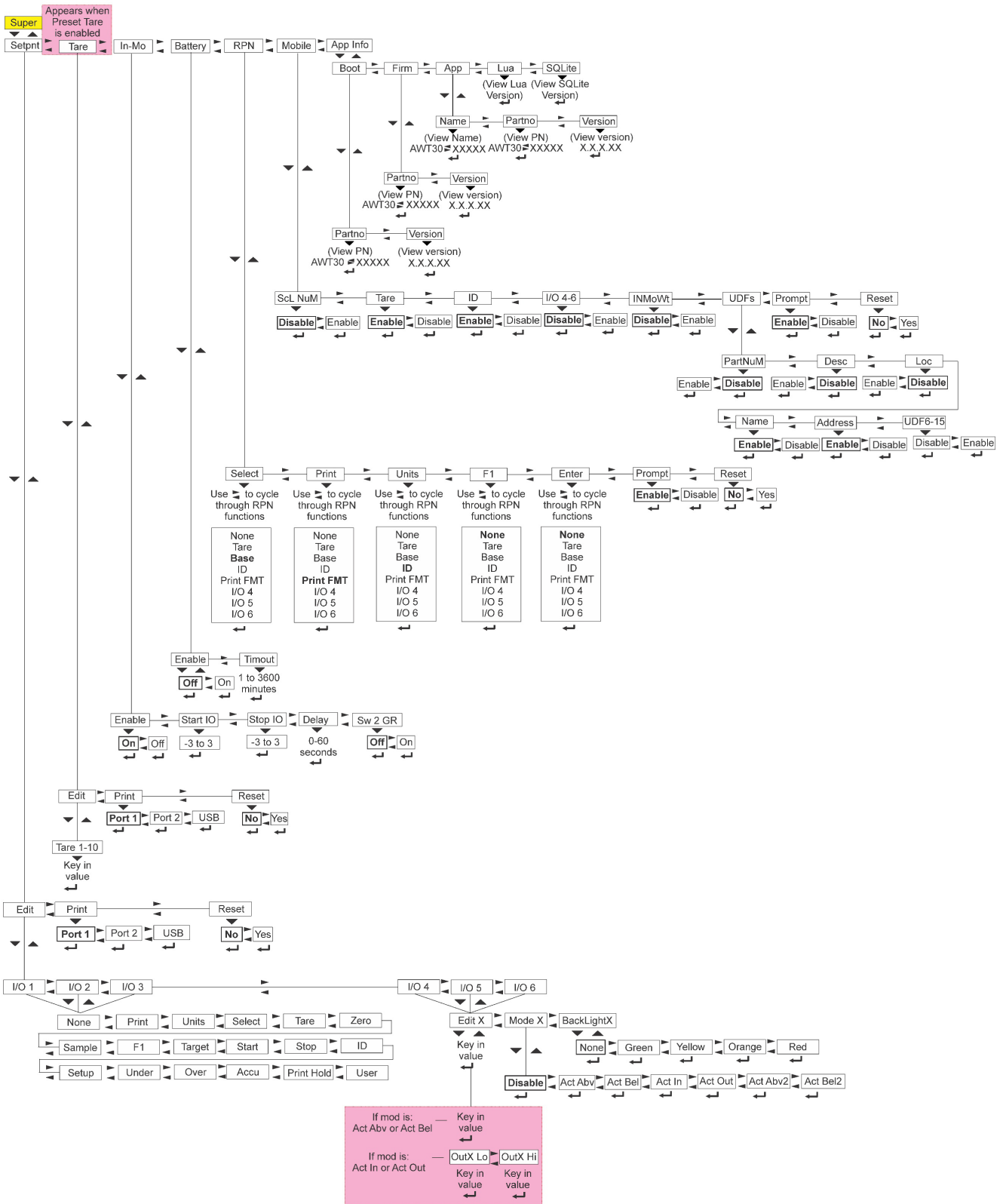

8.11.1 In-Motion App Supervisor Menu Setup

Enable: This controls if the In-Motion function is on or off.

Start IO: This is photo entrance eye to start the weighing process

Stop IO: This is photo exit eye to stop the weighing process

Delay: This controls the delay in seconds (between 0 and 60)

Sw 2 GR: This would switch back to Gross Weight automatically based on your delay setting above. Default setting is **OFF**.

1. Press and hold **F1**...

PASS is now displayed

2. Enter **1793** and press  ...

SuPEr is now displayed

3. Press  until **I/O 1** is displayed

4. Press  until **I/O 4** is displayed

5. Press  ...

EdIT4 is now displayed

6. Press  ...

MOdE 4 is now displayed

7. Press  ...

diSAbIE is now displayed

8. Press  until **ACT-IN** is displayed...

9. Press  ...

MOdE4 is now displayed

10. Press  ...

bKLT4 is now displayed

11. Press  ...

GrEEN is now displayed. Use  to cycle through the backlight color option (**YEllow**, **OrANgE**, **REd**, and **NoNE**)

12. Press  to select a backlight color...

bKLT4 is now displayed

13. Press  ...

I/O4 is now displayed

14. Press  ...

I/O 5 is now displayed

15. Repeat steps 5 thru 12 to set **I/O 5...**
MOdE5 to **ACT- IN**
16. With **bKLT5** displayed press **▲** ...
I/O 5 is now displayed
17. Press **▶** ...
I/O 6 is now displayed
18. Press **▼** ...
EdIT6 is now displayed
19. Press **▶** ...
MOdE6 is now displayed
20. Press **▼** ...
diSAbIE is now displayed
21. Press **▶** ...
ACT-AbV
22. Press **↵** ...
MOdE6 is now displayed
23. Press **▶** ...
bKLT6 is now displayed
24. Press **▼** ...
GrEEN is now displayed. Use **▶** to cycle through the backlight color option (**YElloW**, **OrANgE**, **REd**, and **NoNE**).
25. Press **↵** to select a backlight color...
bKLT6 is now displayed
26. Press **▲** until **SETPNT** is displayed
27. Press **▶** until **IN-Mo** is displayed
28. Press **▼** ...
ENAbIE is now displayed
29. Press **▼** and **▶** if necessary to make sure **ON** is displayed
30. Press **↵** ...
ENAbIE is now displayed
31. Press **▶** ...
StArtIO is now displayed

32. Press ▼ and enter 1 and press ↵

The “1” corresponds to Input 1 on TB2-2 of the ZM223. This setting assumes the entrance photo-eye module is configured to trigger a pulse on a dark to light transition to ensure the item has cleared the photo-eye. To improve weighing accuracy a slight time delay (~0.1 to 0.2 sec) is typically set on the entrance photo-eye programming switches/trim pot so that the signal to start weight averaging is delayed slightly after the item comes onto the scale. A smooth transition of the item from entrance to weighing conveyor can shorten the necessary delay time.

If using a negative edge signal to start weight averaging, then this value would be set to -1

33. With **StArtIO** displayed press ► ...

StoPIO is now displayed.

34. Press ▼ and enter 2 and press ↵

The “2” corresponds to Input 2 on TB2-3 of the ZM223. This setting assumes the exit photo-eye module is configured to trigger a pulse on a light to dark transition so that the weight averaging stops as soon as the item first breaks the path of the beam. Typically, the exit photo-eye is positioned a short distance (a few inches) before the end of the weighing conveyor. No delays should be set on the programming switches/trim pot of the exit photo-eye module.



Note: the minimum amount of time an item should be on the scale is 100 milliseconds but to achieve better accuracy 300ms or longer is recommended.

35. With **StoPIO** displayed press ► ...

dELAY is now displayed. The Delay value will set the length of time the calculated weight is displayed and the check-weigh setpoint output is activated. If the Delay timer is set to 0 then the displayed weight and setpoint output will remain on indefinitely or until the next Start IO signal is received.

36. Press ▼ and enter a value for the Delay Timer and press ↵ ...

dELAY is now displayed.

37. Press ▲ until the display returns to normal operation.

8.12.1 Grades App Supervisor Menu Setup

Grading 1 – 11: This allows users to define the weight range for each Grade. The value that is entered in each Grade becomes the top limit of the grade before it. For example, if you set Grade 1 = 1.01 pound and Grade 2 = 2.01 pounds, everything that weighs between 1.01 pound (the value after the decimal is probably determined by division size) all the way up to and INCLUDING 2.00 pounds will be classified as Grade 1.

Type: This allows users to toggle between Positive and Negative Grading

Tare: This allows users to toggle between the Manual Tare (default) and the Auto Tare functions.







Print: This allows users to choose which available connection port Print commands are sent to: Port1, Port 2, or USB. A USB drive must be plugged into the USB port for any data to be Printed/Saved.

Labels: This allows users to customize how different grades are displayed. For example, if you have items that are below your GRAD1 (Under), it can say, "REJECT" or "FAIL".

Reset Accum: This allows users to reset all accumulator channels back to Zero. Press any numeric key followed by the set RPN key to reset accumulation.

Print Accum: This allows users to print the stored grade values without clearing the accumulated totals. Press any numeric key followed by the set RPN key to reset accumulation.

Press and hold **F1**.

1. Press and hold **F1**.
2. Key in the Weight Value and press  ...
GRAdING is displayed.
3. Press  ...
GRAd 1 is displayed. This is the first weight point that defines the lower limit of Grade 1.
4. Press  ...
The current **GRAd 1** value flashes indicating that you can edit this.
5. Key in the weight for this and press  ...
GRAd 1 is now displayed.
6. Press  to move to the next grading weight point.
GRAd2 is now displayed.
7. Repeat steps 3 through 5 until all grade weight points have been set.
8. Once all the GRAD points have been entered, press  multiple times to exit and return to weighing.

8.13 AutoLoc Setup

AutoLoc: AutoLoc allows the ZM223 to be used for weighing and recording an animal's weight automatically on an animal livestock scale. There are two modes, Standard and Advanced.

1. Press and hold **F1**...
Pass is briefly displayed before the text input prompt
2. Enter the Supervisor Menu Password (1793) and press **←** ...
Super is now displayed
3. Press **▼** ...
Ld-Unld is now displayed
4. Press **▶** ...
AccuM is now displayed.
5. Press **▶** ...
AutoLoc is now displayed.

AutoLoc Mode

AutoLoc Mode: This parameter allows users to select the current AutoLoc Mode (**Standard**, **Advanced**, and **Disable**). The difference between Standard and Advanced modes is that in Advanced mode the ZM223 will lock on to the weight and stay locked even when the weight is removed from the scale. A new AutoLoc weight will only be retriggered upon placing a new weight onto the scale.

6. Press **▼** ...
ALCMode is now displayed
7. Press **▼** ...
disAbIE is now displayed
8. Use **◀** or **▶** to cycle through the print options (**Disable**, **Standard**, or **Advanced**)...
Disable turns off the AutoLoc function.
Standard allows the indicator to do Standard AutoLoc functions.
Advanced allows the indicator to do Advanced AutoLoc functions.
9. Press **←** to make a selection...
ALCMode is now displayed

AutoLoc Min

AutoLoc Min: This parameter allows users to set the Minimum Weight for AutoLoc to trigger.

10. Press **▶** ...
ALC MiN is now displayed.
11. Enter the Minimum Weight for the AutoLoc to lock onto a stable weight and press **←** ...
ALC MiN is now displayed.

AutoLoc Control

AutoLoc Control: This parameter allows users to enter the Percent Weight Change for AutoLoc to trigger.

12. Press **▶** ...

ALCRTOL is now displayed.

13. Press **▼** ...

The current value is displayed.

14. Enter the desired weight percentage for AutoLoc Filter to restart after locking onto a stable weight and press **←** to accept...

ALCRTOL is now displayed.

8.14 PLUs

Super ↓ Setpoint → Tare → [App Menu] → PLU [when applicable]

PLU databases are available with some applications like Counting, Checkweigh Advanced and Percentage Checkweighing. When configured internally, up to 2000 PLUs can be stored on the indicator's micro-SD card.

PLUs are used to quickly recall pre-stored tares and piece weights, along with other useful parameters using a PLU Slot from (1-2000).

Checkweighing Advanced PLU Menus

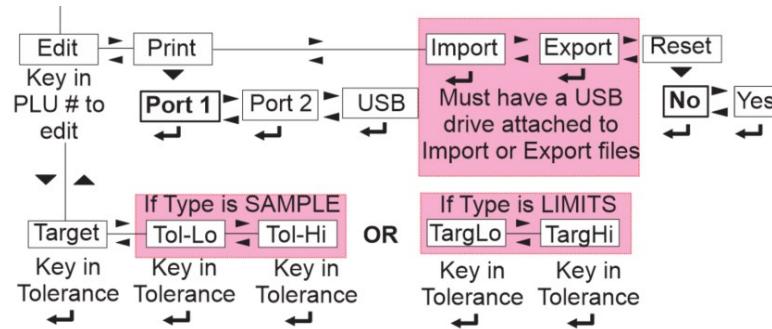

Checkcounting PLU Menus

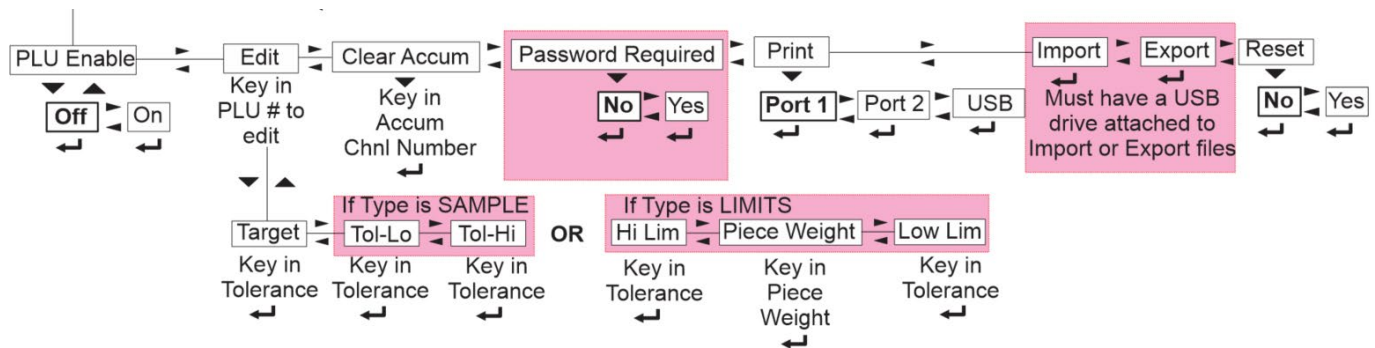

Edit

PLU ↓ Edit

For the Counting App the first PLU Menu is PLU Enable (see below) Followed by the Edit menu item.

1. From **PLU**, press ▼ ...
Edit is now displayed
2. Press ▼ ...
0 is now displayed
3. Key in the desired PLU number and press ↵ ...
4. Use ◀ or ▶ to cycle through the different PLU data fields (**TARGET**, **TOL-LO** and **TOL-HI**) for checkweighing or (**Hi LiM**, **PiEceW**, **TARE1**, **TARE2**, and **Low Li**) for Checkcounting.
5. Press ▼ to edits any of these fields and press ↵ when finished...
6. Press ▲ ...
Edit is now displayed

PLU Enable (only applicable to Counting App)

PLU ↓ PIUEnbl

This enables PLUs to be used in the Counting Application.

7. With the Counting Application running, from **PLU**, press ▼ ...
PluENbl is now displayed
8. Press ▼ ...
OFF is now displayed
9. Press ▶ to toggle between **OFF** and **ON**.
10. Press ↵ to make a selection...
PluENbl is now displayed

Clear Accum (only applicable to Counting App)

PLU ↓ PIUEnbl → Edit → ClrAccm

11. Press ▶ ...
ClrAccM is now displayed
12. Press ▼ ...
PLU is briefly displayed, then a numeric entry screen is displayed.
13. Key in Accum Channel Number and press ↵ ...
ClrAccM is now displayed.

Password Required (only applicable to Counting App)

PLU ↓ PIUEnbl → Edit → ClrAccm → PASSREQ

This allows for a password to be required before making any edits to PLUs in the Counting App.

14. Press ► ...
PASSREQ is now displayed
15. Press ▼ ...
NO is now displayed
16. Press ► to toggle between **NO** and **yES**
17. Press ↵ to make a selection...
PASSREQ is now displayed



Note: When Password Required is active, the Supervisor Menu Password (1793 by default) is required to make any edits to PLUs in the Counting App.

Print

PLU ↓ Edit → Print

18. Press ► ...
PriNT is now displayed
19. Press ▼ ...
Port 1 is now displayed
20. Use ◀ or ▶ to cycle through the different port options (**Port 1**, **Port 2**, and **USB**)
21. Press ↵ to select an option...
PriNt is now displayed

Import

PLU ↓ Edit → Print → Import

To use either the Import or Export function there must be a USB drive attached to the indicator.

22. Press ► ...
IMPort is now displayed
23. Press ▼ ...
BUSY will flash on the display while the indicator completes the Import Process before it returns to **IMPort**.

If there is not a USB drive attached to the indicator “**Err -1**” will briefly display before returning to **IMPort**.

Export

PLU ↓ Edit → Print → Import → Export

24. Press ► ...

ExPort is now displayed

25. Press ▼ ...

BUSY will flash on the display while the indicator completes the Export Process before it returns to **ExPort**.

If there is not a USB drive attached to the indicator “**Err -1**” will briefly display before returning to **ExPort**.

Reset

PLU ↓ Edit → Print → Import → Export → Reset

26. Press ► ...

RESET is now displayed

27. Press ▼ ...

No is now displayed.

28. Use ◀ or ▶ to cycle through the different port options (**No** or **yES**)

29. Press ↵ to select an option...

RESET is now displayed

8.15 Battery

Super ↓ Setpoint → Tare → [App Menu] → PLU [when applicable] → Battery

Battery: Use this to enable the battery and to set a timeout length (in minutes). If this time expires with no scale or keypad activity, setpoint #3 will change states so the battery will shut off if the proper external circuitry is provided.

1. From **Tare**, press ► ...

bATTERY is now displayed.

Enable

Battery ↓ Enable

Only enable the battery and set the timeout value if the battery has the proper external shutoff circuitry. If battery use is enabled, setpoint output 3 cannot be used for setpoints in any application. It is used as a shutoff signal.

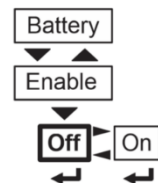

2. Press ▼ ...

EnAbLE is now displayed. Choices are **oFF** and **on**. Choose **oFF** to disable battery usage. Choose **on** to enable battery usage.

3. Press ► to toggle between the choices and when your choice is

displayed, press ↵ to accept ...

EnAbLE is now displayed.

Timeout

Battery ↓ Enable → Timeout

Timeout: This stands for timeout. Use this to set the length of time before inactivity of the scale and keypad cause battery power to be shut off. Values between 1 and 3600 minutes are valid. **This function only works if the battery has shutoff circuitry.**

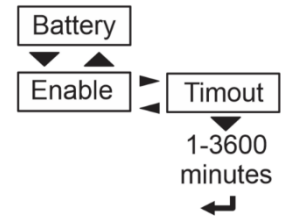

4. Press ...
tMout is now displayed.
5. Press ...
A numeric entry screen appears.
6. Key in a value, in minutes and press to accept ...
tMout is now displayed.
7. This completes the Supervisor menu for General Weighing. Repeatedly press until the indicator returns to normal weighing mode. The current weight value is now displayed.

8.16 RPN

Super ↓ Setpoint → Tare → [App Menu] → Battery → RPN

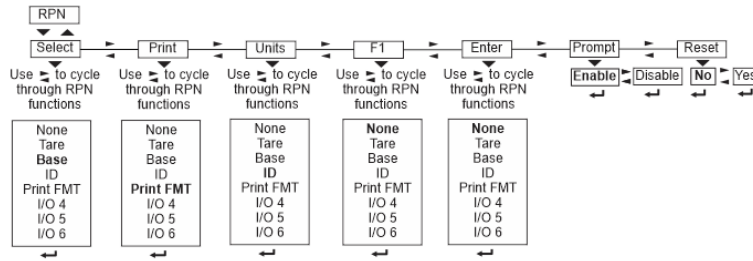

RPN (Reverse Polish Notation): This allows users to program some of the indicator's keys to have a secondary function. RPN works by entering the required function number and the desired key selected for that function. RPN functions allow operators to enter in numeric data for a secondary key function like entering a known Piece Weight, an Operator ID, a Target Value, an Output Value, or PLU. Once a key has been selected for the RPN function, like a Target Weight, key in the value using the numeric keypad and then press the set RPN activation key. The display will flash the entered value and RPN function before returning to the live weight display. To cancel the RPN entry and return to normal operation press the **C** key. The above menu map is for the General Weighing Application. Other applications will have different RPN functions available.

	Application													
	General	Accum	Count	Check Simp	Check Mid	Check Adv	Check Grade	Check by %	Truck In/Out	Batch -ing	P-Hold	Remote Display	In-Motion	
Tare	X	X	X		X	X	X	X	X	X		X	X	
Base	X	X	X	X	X	X	X	X	X	X	X	X	X	
ID	X	X	X	X	X	X	X	X	X	X	X	X	X	
Print Format	X	X	X	X	X	X	X	X	X	X	X	X	X	
I/O 4	X	X	X						X	X	X	X	X	
I/O 5	X	X	X						X	X	X	X	X	
I/O 6	X	X	X						X	X	X	X	X	
Accumulation Channel		X												
Preact 4										X				
Preact 5										X				
Preact 6										X				
Start										X				
Stop										X				
Truck ID									X					
Light Setting									X					
Under Segment Division				X		X		X						
Over Segment Division				X		X		X						
Under Division				X		X		X						
Over Division				X		X		X						
Target				X	X	X		X						
Target Low				X	X	X		X						
Tolerance Low				X	X	X		X						
Target High				X	X	X		X						
Tolerance High				X	X	X		X						
Piece Weight			X											
Sample Size			X											
PLU			X			X		X						

8.20 Mobile

Super ↓ Setpoint → Tare → [App Menu] → Battery → RPN → Mobile

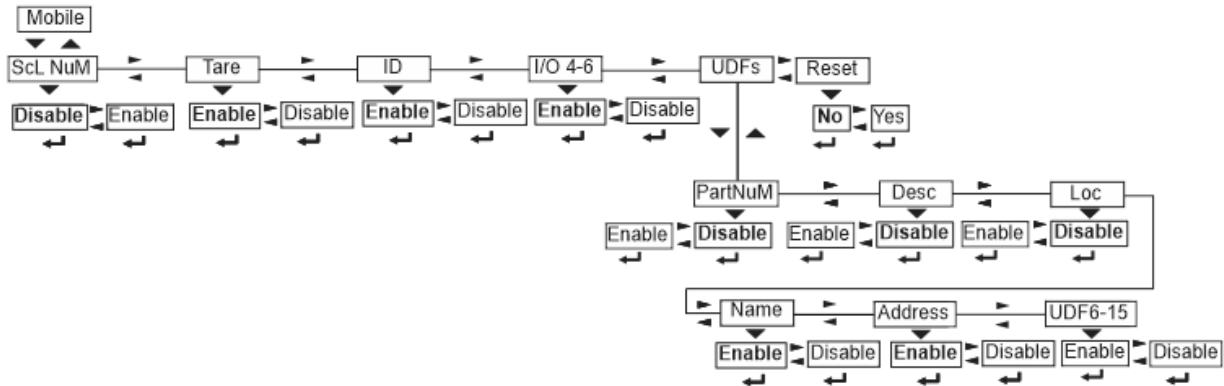

Mobile: This controls what fields can be seen/used on the Remote Assist Mobile App. This section is split into two sections: Scale-Related fields and UDF fields. The available fields depend on what app the ZM223 is running.

Available RPN Functions	Application												
	General	Accum	Count	Check			Check Grade	Check by %	Truck In/Out	Batching	P-Hold	Remote Display	In-Motion
				Simp	Mid	Adv							
Tare Weight	X	X	X		X	X	X	X	X	X	X	X	X
ID	X	X	X	X	X	X	X	X	X	X	X	X	X
I/O 4-6	X	X						X	X	X	X	X	X
Accumulation Channel		X											
Preact 4 – 6										X			
Gross, Net, Tare									X				
Description			X										
Inbound WT									X				
Outbound WT									X				
PLU			X			X		X					
Grade 1-11							X						
Transaction									X				
Target			X		X	X		X					
Low			X	X	X	X		X					
High			X	X	X	X		X					
Piece Weight			X	X	X	X							
Part Number			X	X	X	X		X					



Note: The above menu map is for the General Weighing Application. Other applications will have different Remote Assist Mobile App options available.

8.21 App Info

Super ↓ Setpoint → Tare → [App Menu] → Battery → RPN → Mobile → App Info

App Info: This allows users to view the Name, Part Number, and Version of the software running on the ZM223.

The viewable fields are:

- Bootloader
- Firmware
- Application
- Lua
- SQLite

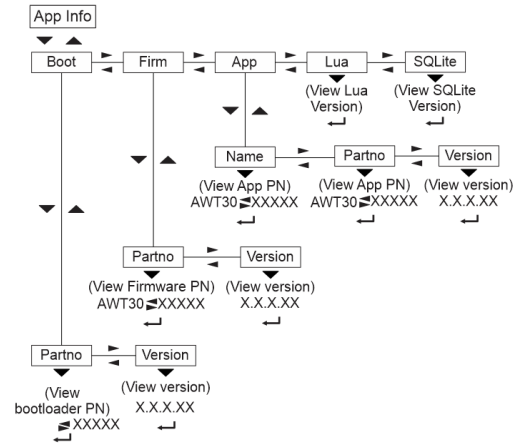

9 Communications

The ZM223 can communicate through these ports:

- Serial
- Ethernet
- USB
- Bluetooth
- Wireless 802.11g

9.1 Default Print Formats



Users can quick select a Print Format by using the keypad. For example, key in 1 9 and press the **PRINT** key to print a ticket using Print Format 19, 3 5 to get Print Format 35, etc.



Note: The below ticket examples are close approximations of how the different print formats look when used. There may be small differences in font, size, and formatting when printing in the field.

Print Format Number	Description	Example Ticket
1	General App. Default	<pre> Gross 3000 lb Tare 1000 lb Net 2000 lb </pre>
2	Accumulate App. Default (see PF 8 for Totals)	<pre> Acc # 1 Trans # 3 Gross 3000 lb Tare 1000 lb Net 2000 lb </pre>
3	Count App. Default (see PF 31 for Totals)	<pre> Count 150 </pre>
4	Net Weight	<pre> Net 2000 lb </pre>
5	Displayed Weight	<pre> G 2000 lb </pre>
6	Peak App. Default	<pre> Peak 6000 lb </pre>
7	Remote App. Default (broadcast this format to remote)	<pre> 1000 lb G </pre>

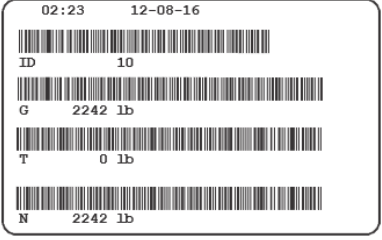
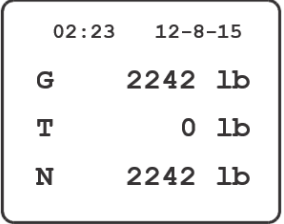
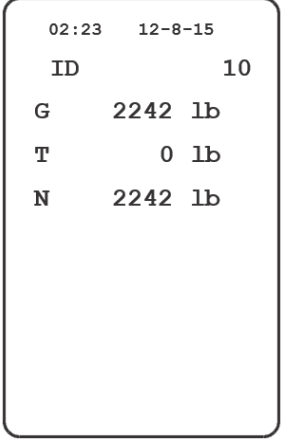
Print Format Number	Description	Example Ticket
8	Accumulate Totals App. Default (see PF 2 for print out)	<pre> Acc # 1 Trans # 3 Gross Total 9000 lb Tare Total 2000 lb Net Total 7000 lb </pre>
9	CONDEC clone format	<pre> 1000LG </pre>
10	Displayed Weight with Tare Register number	<pre> 1 G 1000 lb </pre>
11	Displayed Weight with Status (3- bytes)	<pre> G 2000 lb 822 </pre>
12	Displayed Weight with Status (Alphanumeric)	<pre> G 5000 lb S </pre>
13	Basic Weight Ticket with Time, Date, and Site ID number	<pre> 02:21:28 04-23-2015 ID 141414 Gross 5000 lb Tare 1000 lb Net 4000 lb </pre>
14	Basic Weight Ticket with Time, Date, and Tare Register number	<pre> 02:21:28 04-23-2015 G 5000 lb 1 T 1000 lb N 4000 lb </pre>
15	Accumulated Gross Weight (Used with Accumulate or Count Apps.)	<pre> Gross Total 5000 lb </pre>
16	Accumulated Net Weight (Used with Accumulate or Count Apps.)	<pre> Net Total 8002 lb </pre>
17	Basic Accumulate Ticket for GTN values (Used with Accumulate or Count Apps.)	<pre> Gross Total 20002 lb Tare Total 12000 lb Net Total 8002 lb </pre>
18	Minimum Peak Weight Value Or Peak Min and Max	N/A

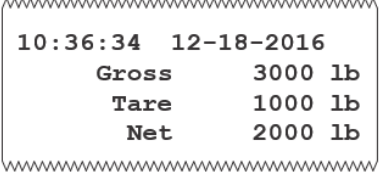
Print Format Number	Description	Example Ticket
19	2.5 in. X 4.0 in. Barcode Ticket with Site ID, Time and Date	 <p>02:23 12-08-16 ID 10 G 2242 lb T 0 lb N 2242 lb</p>
20	1.25 in. X 1.0 in. Thermal Label Ticket with Time and Date	 <p>02:23 12-8-15 G 2242 lb T 0 lb N 2242 lb</p>
21	2.50 in. X 4.0 in. Thermal Label Ticket with ID, Time and Date	 <p>02:23 12-8-15 ID 10 G 2242 lb T 0 lb N 2242 lb</p>
22	4.0 in. X 6.0 in. Thermal Label Ticket with ID, Time and Date	 <p>02:23 12-8-15 ID 10 G 2242 lb T 0 lb N 2242 lb</p>
23	Same as PF1 with Time and Date first	 <p>10:36:34 12-18-2016 Gross 3000 lb Tare 1000 lb Net 2000 lb</p>

Print Format Number	Description	Example Ticket
24	Same as PF1 with Time and Date last	<pre> Gross 3000 lb Tare 1000 lb Net 2000 lb 10:36:34 12-18-2016 </pre>
25	Gross Weight & Time & Date	<pre> Gross 3001 11:54:46 12-18-2014 </pre>
26	Brecknell RD- 65 (Setup RD for Data Format #3)	<pre> G 6210 lb </pre>
27	In-Motion App. Default	<pre> G 5000 lb </pre>
28	In_Motion App. (Alternate)	<pre> Gross 28.0 lb Net 16.0 lb Tare 12.0 lb </pre>
29	Data Stream for (UK) Legacy PC application	3327 0 00M99 9
30	Bind Forward	<pre> Gross 3000 lb Tare 1000 lb Net 2000 lb </pre>
31	Count Totals App. Default (see PF 3 for print out)	<pre> Count Total 250 </pre>
32	Used for Analog Output Option Card (Gross Cal Weight)	<pre> 120032 </pre>
33	XR4500TL Remote Display setup for Command Mode #3	<pre> 1000 G1 </pre>
34	GSE Remote HUB interface format.	<pre> 0.000000 </pre>
35	Single transaction of accumulated GTN data (see PF 8 or PF 9 for Totals Mode dependant)	<pre> PLU # 1 Trans # 3 Gross 3000 lb Tare 1000 lb Net 2000 lb </pre>

Print Format Number	Description	Example Ticket
36	Accumulate Totals for PLU # (see PF 2 for print out) Advanced Mode only	<pre> ***** PLU # 3 Trans # 2 Gross Total 26.5 lb Net Total 26.5 lb ***** </pre>
37	Accumulate Totals (see PF 2 for print out) Mid375 Mode only	<pre> ***** Trans # 2 Gross Total 26.5 lb Net Total 26.5 lb ***** </pre>
38	ZM223 Checkweigher Under/Accept/ Over Band	<pre> ***** OVER : 0.378 lb ***** </pre>
39	ZM223 Checkweigher Accept/Reject Band	<pre> ***** REJECT : 0.542 lb ***** </pre>
40	ZM223 Net Weighment with Band	<pre> ***** 1.176 lb OVER ***** </pre>
41	ZM223 Standard Deviation Stats.	<pre> ***** Tol Hi = 0.550 lb Tol Lo = 0.240 lb Target = 16.000 lb # Over = 5 # Under = 4 #Accept = 5 Mean = 16.504 lb Max Wt = 17.504 lb Min Wt = 15.003 lb Std Dev = 1.370 C of V = 1.202 PCT # Smpl = 14 ***** </pre>
42	ZM223 X-Bar/R Stats. with Trend Message if a trend condition exists.	<pre> ***** Tol Hi = 3.100 lb Tol Lo = 2.900 lb Target = 3.000 lb Ave Wt = 3.526 lb Range = 1.200 lb ***** </pre>
43	ZM223 Grading	<pre> ***** Grad3 6.005 lb ***** </pre>
45	Scale 1	<pre> ***** Gross 1 0 lb Tare 1 0 lb Net 1 0 lb ***** </pre>
46	Scale 2	<pre> ***** Gross 2 0 lb Tare 2 0 lb Net 2 0 lb ***** </pre>

Print Format Number	Description	Example Ticket
47	Scale 1 and 2 Total	Gross 1 0 lb Tare 1 0 lb Net 1 0 lb Gross 2 0 lb Tare 2 0 lb Net 2 0 lb Gross Total 0 lb Tare Total 0 lb Net Total 0 lb
48	Inbound Ticket	<pre> ~~~~~ In Date 2015-03-25 In Time 10:50:45 ID 38577 In Weight 14300 lb ~~~~~ </pre>
49	Inbound Report Header	<pre> Inbound Vehicle Report 10:36:41 03-25-2015 ID Time Date Weight ----- </pre>
50	Inbound Report Body of Data	<pre> 966558 20:17 3-9-2015 49300 lb 561152 22:41 3-11-2015 6800 lb 443216 13:05 3-18-2015 59000 lb 606912 5:53 3-18-2015 11620 lb 394736 1:05 3-18-2015 13380 lb </pre>
51	Inbound Report Footer	<pre> Gross 0 lb Tare 0 lb Net 0 lb End of Fleet Report End of Inbound Report </pre>
52	Outbound Ticket	<pre> ~~~~~ In Date 2015-03-25 In Time 10:50:45 Out Date 2015-03-25 Out Time 10:56:04 ID 38577 Transaction 51 Gross 51040 lb Tare 14300 lb Net 36740 lb ~~~~~ </pre>
53	Outbound Report Header	<pre> Outbound Vehicle Report 10:39:32 03-25-2015 ID # Trans Total Net Wt ----- </pre>
54	Outbound Report Body of Data	<pre> 674758 2 130400 lb 806039 2 99200 lb 961564 6 250100 lb 735023 5 317900 lb 495520 10 361200 lb </pre>
55	Outbound Report Footer	<pre> End of Outbound Report </pre>

Print Format Number	Description	Example Ticket
56	Fleet Ticket	<pre> Date 2015-03-25 Time 10:51:24 Fleet ID 759111 Transaction 192 Gross 69080 lb Tare 14100 lb PT Net 54980 lb </pre>
57	Fleet Report Header	<pre> Fleet Vehicle Report 10:43:40 03-25-2015 Fleet ID Tare Wt # Trans Total Net Wt ----- </pre>
58	Fleet Report Body of Data	<pre> 759109 20500 lb 14 1148000 lb 8262677 12280 lb 32 1571840 lb 8262686 11880 lb 41 1948320 lb 8262691 11940 lb 54 2579040 lb 8262671 11880 lb 56 2661120 lb </pre>
59	Fleet Report Footer	End of Fleet Report
60	Reprinted Data Identifier	***** REPRINT *****
61	GTN Boca	<pre> 01:45:26 04-15-2026 Gross 0 lb Tare 0 lb Net 0 lb </pre>
62	Inbound Ticket Label Boca	<pre> In Date 0 In Time 0 TRUCK ID 0 In Weight 0 0 </pre>
63	Inbound Rpt Header Label Boca	<pre> Inbound Vehicle Report 14:29:24 04-15-2026 TRUCK Time Date Weight ----- </pre>
64	Inbound Rpt Body Label Boca	<pre> 0 0 0 0 0 </pre>
65	Inbound Rpt Footer Label Boca	End of Inbound Report
66	Outbound Ticket Label Boca	<pre> In Date 0 In Time 0 Out Date 0 Out Time 0 TRUCK ID 0 Trans# 0 Gross 0 0 Tare 0 0 Net 0 0 </pre>
67	Outbound Rpt Header Label Boca	<pre> Outbound Vehicle Report 14:44:42 04-15-2026 TRUCK # Trans Total Net Wt ----- </pre>
68	Outbound Rpt Body Label Boca	<pre> 0 0 0 0 </pre>
69	Outbound Rpt Footer Label Boca	End of Outbound Report

Print Format Number	Description	Example Ticket
70	Fleet Ticket Label Boca	<pre> Date 0 Time 0 Fleet ID 0 Trans# 0 Gross 0 0 Tare 0 0 Net 0 0 </pre>
71	Fleet Rpt Header Label Boca	<pre> Fleet Vehicle Report 15:29:00 04-15-2026 TRUCK Tare Wt # Trans Total Net Wt ----- </pre>
72	Fleet Rpt Body Label Boca	<pre> 0 0 0 0 0 0 </pre>
73	Fleet Rpt Footer Label Boca	<pre> Gross 0 lb Tare 0 lb Net 0 lb End of Fleet Report </pre>
74	Normal Print Identifier Boca	<pre> Gross 0 lb Tare 0 lb Net 0 lb End of Fleet Report </pre>
75	RePrint Identifier Boca	<pre> ***** REPRINT ***** </pre>
76	Inbound Rpt Header	<pre> Inbound Vehicle Report 15:32:28 04-15-2026 ID Time Date Weight ----- </pre>
77	Inbound Rpt Body	<pre> 0, 0, 0, 0 0 </pre>
78	Inbound Rpt Footer	<pre> End of Inbound Report </pre>
79	Outbound Rpt Header	<pre> Outbound Vehicle Report 15:33:42 04-15-2026 ID # Trans Total Net Wt ----- </pre>
80	Outbound Rpt Body	<pre> 0, 0, 0 0 </pre>
81	Outbound Rpt Footer	<pre> End of Outbound Report </pre>
82	Fleet Rpt Header	<pre> Fleet Vehicle Report 15:34:25 04-15-2026 Fleet ID Tare Wt # Trans Total Net Wt ----- </pre>
83	Fleet Rpt Body	<pre> 0, 0 0, 0, </pre>
84	Fleet Rpt Footer	<pre> End of Fleet Report </pre>

Print Format Number	Description	Example Ticket
85	Inbound Ticket Label Boca with barcode	<pre style="text-align: right;"> In Date 0 In Time 0 TRUCK ID 0 In Weight 0 * 0*</pre>
86	GTN ID T&D 1.25x1 Zebra	<pre style="text-align: right;"> 12:25:51 04-21-2026 ID 0 G 0 lb T 0 lb N 0 lb</pre>
87	GTN ID T&D 2.25x4 Zebra	<pre style="text-align: right;"> 12:25:51 04-21-2026 ID 0 G 0 lb T 0 lb N 0 lb</pre>
88	GTN ID T&D 4x6 Zebra	<pre style="text-align: right;"> 12:25:51 04-21-2026 ID 0 G 0 lb T 0 lb N 0 lb</pre>

Print Format Number	Description	Example Ticket
89	GTN ID T&D 2.25x4 Zebra Ticket Roll Paper	12:25:51 04-21-2026 ID 0 G 0 lb T 0 lb N 0 lb
90	GTN T&D 4x6 Zebra Ticket Roll Paper	12:25:51 04-21-2026 G 0 lb T 0 lb N 0 lb
91	GTN ID T&D Customer 2.25x3 r270 Zebra	04-21-2026 12:25:51 ID 0 G 0 lb T 0 lb N 0 lb Customer Name
92	GTN ID T&D NiBC 4x3 Zebra	12:29:58 04 G 0 T 0 N 0  *0*

Print Format Number	Description	Example Ticket
93	GWT lb/kg ID T&D 4x3 Zebra	<p style="text-align: center;">0</p> <p style="text-align: center;">4-21-2026 12:30:30</p> <p>GROSS WT: 0 lb</p> <p style="text-align: right;">0.0 kg</p>
94	DSPWT T&D 4x6 r270 Zebra	<p style="text-align: center; font-size: 2em;">0 lb</p> <p style="text-align: center;">12:31:24 4/21/2026</p>
95	GTN T&D 4x6 w UDF 1-5 Ticket Roll Paper Zebra	<p>12:29:58 04-21-2026</p> <p>G 0 lb</p> <p>T 0 lb</p> <p>N 0 lb</p> <p>PartNum ABC</p> <p>Desc ABC</p> <p>Loc ABC</p> <p>Name ABC</p> <p>Address ABC</p>

Print Format Number	Description	Example Ticket	
96	GTN T&D 4x6 UDFs Ticket Roll Paper w_Cutter Zebra	12:29:58	04-21-2026
		G 0	lb
		T 0	lb
		N 0	lb
		PartNum	ABC
		Desc	ABC
		Loc	ABC
		Name	ABC
		Address	ABC
97	2.25x4 GTN T&D GoDex	11:03:34	4-24-2026
		G 0	lb
		T 0	lb
		N 0	lb
98	4x6 GTN ID T&D GoDex	11:03:34	4-24-2026
		ID 0	
		G 0	lb
		T 0	lb
		N 0	lb
99	Peak Net w T+D	Peak Max 0 lb 03:37:21 pm 04-15-2026	
100	Peak Net w T+D CSV	Peak Max, 0,lb,03:37:04 pm,04-152026	

9.2 Error Messages

The following error messages may be displayed during use of the indicator:

Message	Display
Overload	
Can't fit on display or load cell not properly connected	-----
Underload	-----
Can't	cAnt
Entry not in valid range	boundS
Password entry failed	inVALid
Remote display not receiving data from the master indicator	no dAtA
Indicator did not reach a stable zero weight within time window set for automated weighing process.	2-LoCH PrESS ZEro
Indicates the battery is enabled and TMOUT value is set but the indicator is not operating with the proper battery shutoff circuitry	--oFF--

10. Technical Illustrations

10.1 Desktop Indicator

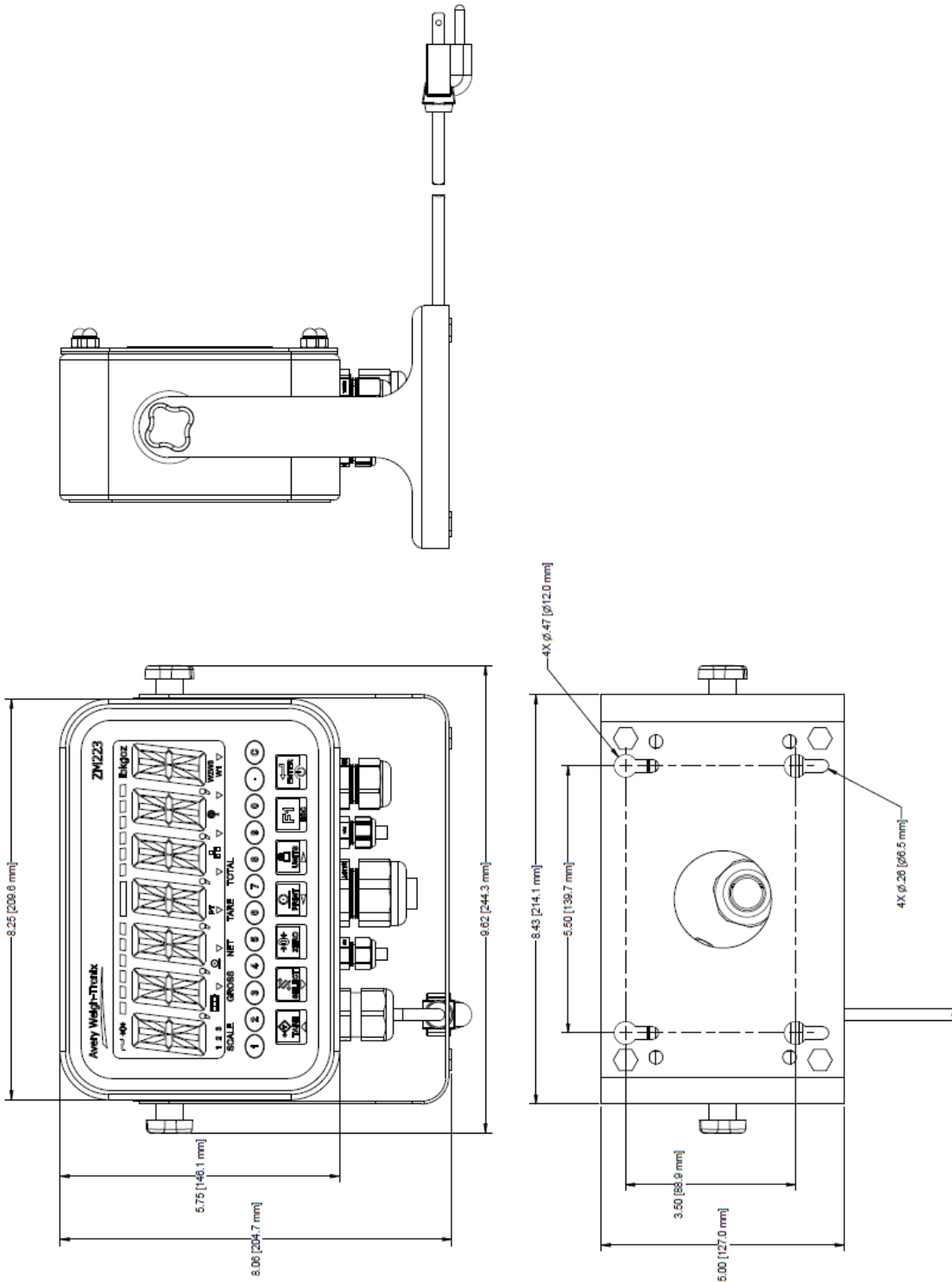

10.2 Panel Mount Indicator

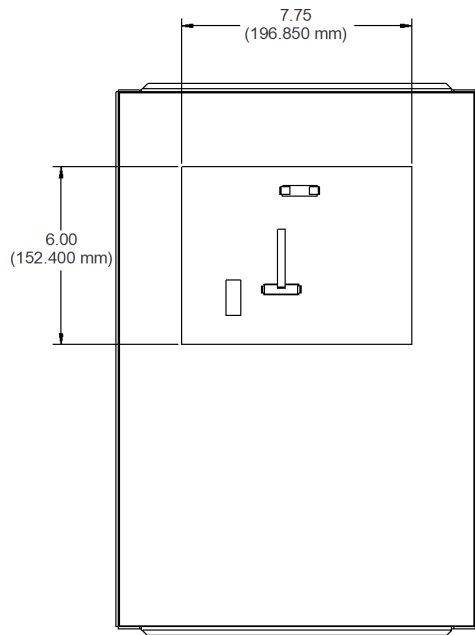

CUTOUT DIMENSIONS

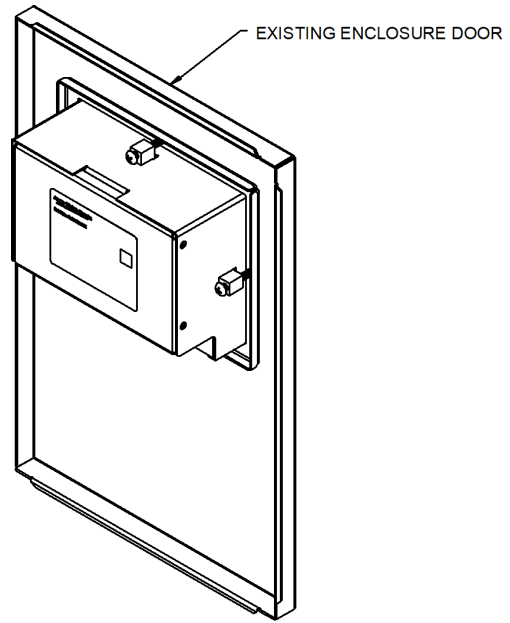

INSIDE VIEW ASSEMBLY

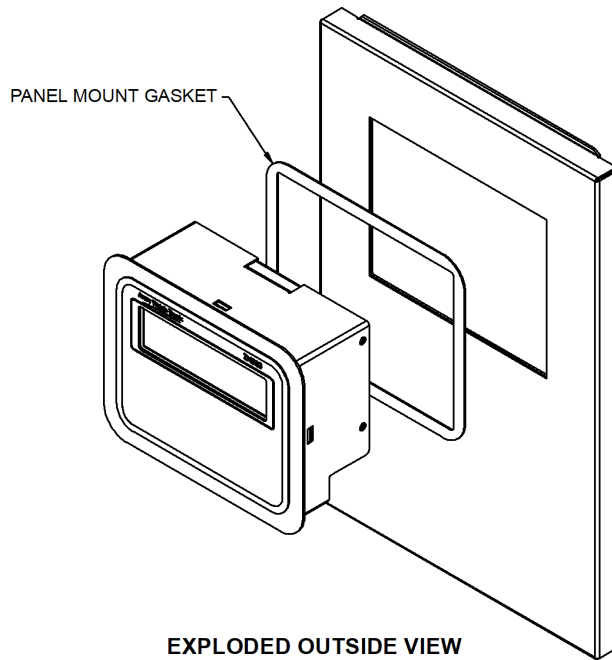

EXPLODED OUTSIDE VIEW ASSEMBLY

Avery Weigh-Tronix

Avery Weigh-Tronix USA

1000 Armstrong Dr.

Fairmont MN 56031 USA

Tel: 507-238-4461

Fax: 507-238-4195

Email: usinfo@awtx-itw.com

www.averyweigh-tronix.com

Avery Weigh-Tronix UK

Foundry Lane,

Smethwick, West Midlands,

England B66 2LP

Tel: +44 (0) 8453 66 77 88

Fax: +44 (0)121 224 8183

Email: info@awtx-itw.com

www.averyweigh-tronix.com