

235 Series

Mechanical

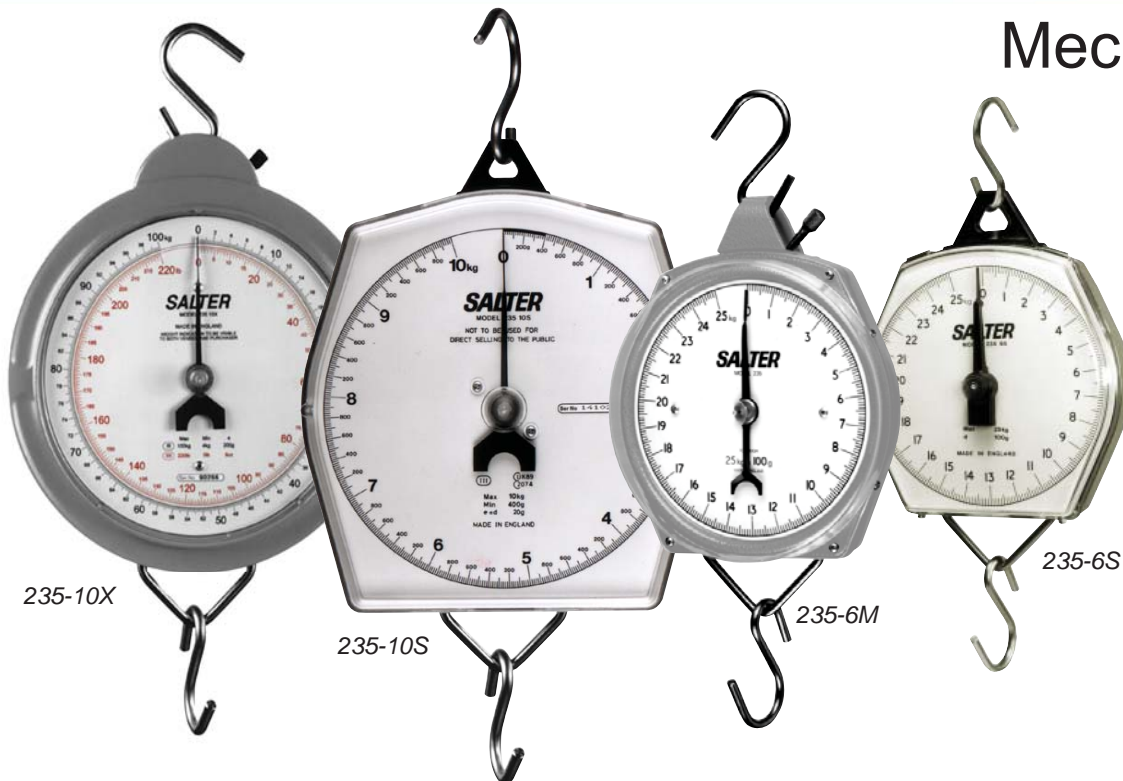

- Robust
- Accurate
- Reliable
- Portable
- Dual Markings Available for Metric and Avoirdupois
- Low Cost
- Easy-to-Read
- Corrosion Resistant
- Capacities- 1 kg / 11 lb to 300 kg / 660 lb

VALUE IN WEIGHING

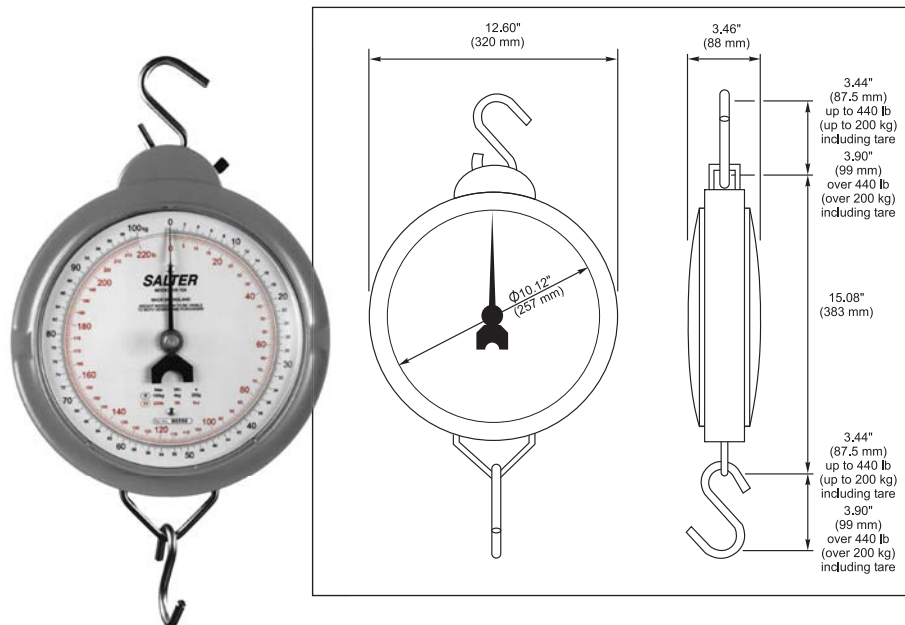

Model 235-10X

Heavy duty suspended scale. Easy to read dial housed in a robust die cast casing. Low friction bearings provides positive movement to give maximum sensitivity. Accurate to one part in 500 with up to 10% zero adjustment. Supplied with top and bottom hooks as standard.

Single Marked

100 kg x 200 g
200 kg x 500 g
300 kg x 1 kg

Dual Marked

200 kg x 500 g / 440 lb x 1 lb

With Double Lipped Scoop

5 kg x 10 g

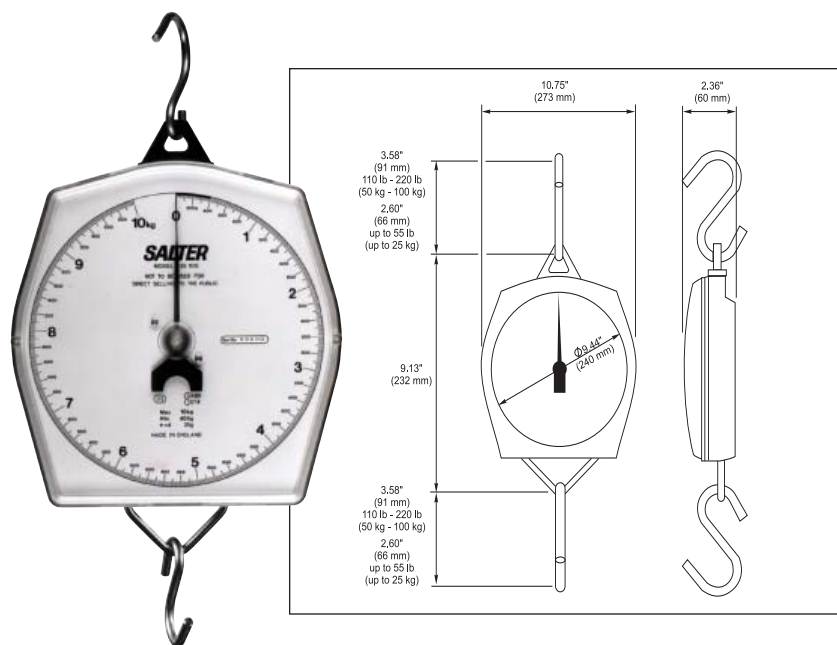

Model 235-10S

Robust and corrosion resistant, large easy to read 254 mm diameter dial housed in a tough ABS plastic case with a shatterproof polycarbonate dial cover. Low friction bearings provide positive movement to give maximum sensitivity. Accurate to one part in 500 with up to 15% zero adjust. Supplied with top and bottom hooks.

Option - Oblong pan (5 kg / 11 lb only)

Single Marked

5 kg x 10 g
10 kg x 20 g
25 kg x 50 g
50 kg x 100 g
100 kg x 200 g