

ZM401/405 Indicators



User Instructions

Avery Weigh-Tronix is a trademark of the Illinois Tool Works group of companies whose ultimate parent company is Illinois Tool Works Inc (“Illinois Tool Works”). Copyright © 2018 Illinois Tool Works. All rights reserved.

No part of this publication may be reproduced by making a facsimile copy, by the making of a copy in three dimensions of a two-dimensional work and the making of a copy in two dimensions of a three-dimensional work, stored in any medium by electronic means, or transmitted in any form or by any means, including electronic, mechanical, broadcasting, recording or otherwise without the prior written consent of the copyright owner, under license, or as permitted by law.

This publication was correct at the time of going to print, however Avery Weigh-Tronix reserves the right to alter without notice the specification, design, price or conditions of supply of any product or service at any time.

Table of Contents

	<i>page</i>
Table of Contents	3
Chapter 1 General information and warnings	5
About this manual	5
Text conventions	5
Special messages	5
Installation	5
Safe handling of equipment with batteries	6
Wet conditions	6
Routine maintenance	6
Cleaning the machine	7
Training	7
Sharp objects	7
FCC and EMC declarations of compliance	7
Declarations of Conformity	8
Chapter 2 Introduction	10
Front panel	11
Display	13
Powering up a ZM400 series indicator	14
Alphanumeric entry procedure (ZM401 only)	14
Using the alphanumeric keypad (ZM405 only)	15
Entering negative numbers or decimal point	15
Chapter 3 Indicator applications	16
General weighing application	16
SELECT key default function	16
Gross weighing	16
Net weighing	16
Using setpoints	19
Printing	19
Chapter 4 Menus	20
Accessing the menus	20
Menu annunciators	20
Exiting the menus	21
USER level menus	21
User menu	22
Time	22
Date	23
Site ID	24
Seal	24
About menu	25
Boot (Bootloader)	26
Firmware	26
App	26
Serial	26
Option	27
Enet	27
Download	28
BSQ	28
Audit menu	29

Counter	29
Print	30
Chapter 5 Supervisor menu (ZM405 only)	31
Creating a new Preset Tare	32
Editing an existing Preset Tare	32
Printing the Preset Tare list	32
Resetting the Preset Tare list	33
Printed Preset Tare report example	33
Chapter 6 Communications	34
Default print formats	34
Chapter 7 Error messages	35

1 General information and warnings

1.1 About this manual

This manual is divided into chapters by the chapter number and the large text at the top of a page. Subsections are labeled as shown by the 1.1 and 1.1.1 headings. The names of the chapter and the next subsection level appear at the top of alternating pages of the manual to remind you of where you are in the manual. The manual name and page numbers appear at the bottom of the pages.

1.1.1 Text conventions

Key names are shown in **bold** and reflect the case of the key being described. If a key has a dual function it may be referred to by its alternate function.

Displayed messages appear in ***bold italic*** type and reflect the case of the displayed message.

Annunciator names appear as *italic* text and reflect the case of the annunciator.

1.1.2 Special messages

Examples of special messages you will see in this manual are defined below. The signal words have specific meanings to alert you to additional information or the relative level of hazard.



CAUTION!

This is a Caution symbol.

Cautions give information about procedures that, if not observed, could result in damage to equipment or corruption to and loss of data.



NOTE: *This is a Note symbol. Notes give additional and important information, hints and tips that help you to use your product.*

1.2 Installation



NO USER SERVICEABLE PARTS. REFER TO QUALIFIED SERVICE PERSONNEL FOR SERVICE.

1.2.1 Safe handling of equipment with batteries



CAUTION: *Danger of explosion if battery is incorrectly replaced. Replace only with the same or equivalent type recommended by the manufacturer. Dispose of used batteries according to the manufacturer's instructions.*

ATTENTION: *Il y a danger d'explosion s'il y a remplacement incorrect de la batterie, remplacer uniquement avec une batterie du même type ou d'un type équivalent recommandé par le constructeur. Mettre au rebut les batteries usagées conformément aux instructions du fabricant.*

1.2.2 Wet conditions

Under wet conditions, the plug must be connected to the final branch circuit via an appropriate socket / receptacle designed for washdown use.

Installations within the USA should use a cover that meets NEMA 3R specifications as required by the National Electrical Code under section 410-57. This allows the unit to be plugged in with a rain tight cover fitted over the plug.

Installations within Europe must use a socket which provides a minimum of IP56 protection to the plug / cable assembly. Care must be taken to make sure that the degree of protection provided by the socket is suitable for the environment.

1.3 Routine maintenance



IMPORTANT: *This equipment must be routinely checked for proper operation and calibration. Application and usage will determine the frequency of calibration required for safe operation.*

Always isolate the indicator from the power supply before starting any routine maintenance to avoid the possibility of electric shock.

1.4 Cleaning the machine

Table 1.1 Cleaning DOs and DON'Ts

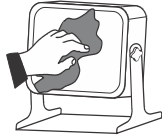

DO	DO NOT
Wipe down the outside of standard products with a clean cloth, moistened with water and a small amount of mild detergent	Attempt to clean the inside of the machine
	Use harsh abrasives, solvents, scouring cleaners or alkaline cleaning solutions
Spray the cloth when using a proprietary cleaning fluid	Spray any liquid directly on to the display windows

1.5 Training

Do not attempt to operate or complete any procedure on a machine unless you have received the appropriate training or read the instruction books.

To avoid the risk of RSI (Repetitive Strain Injury), place the machine on a surface which is ergonomically satisfactory to the user. Take frequent breaks during prolonged usage.

1.6 Sharp objects

Do not use sharp objects such as screwdrivers or long fingernails to operate the keys.

1.7 FCC and EMC declarations of compliance

United States

This equipment has been tested and found to comply with the limits for a Class A digital device, pursuant to Part 15 of the FCC Rules. These limits are designed to provide reasonable protection against harmful interference when the equipment is operated in a commercial environment. This equipment generates, uses, and can radiate radio frequency energy and, if not installed and used in accordance with the instruction manual, may cause harmful interference to radio communications. Operation of this equipment in a residential area is likely to cause harmful interference in which case the user will be required to correct the interference at his own expense.

Canada

This digital apparatus does not exceed the Class A limits for radio noise emissions from digital apparatus set out in the Radio Interference Regulations of the Canadian Department of Communications.

Le présent appareil numérique n'émet pas de bruits radioélectriques dépassant les limites applicables aux appareils numériques de la Classe A prescrites dans le Règlement sur le brouillage radioélectrique édicté par le ministère des Communications du Canada.

European Countries

WARNING: This is a Class A product. In a domestic environment, this product may cause radio interference in which the user may be required to take adequate measures.

1.8 Declarations of Conformity





ES	Declaración UE de Conformidad	Modelo / Tipo: ZM4xx
<p>Nombre y dirección del fabricante: Avery Weigh-Tronix® Foundry Lane Smeethwick Station Road, Egham, Surrey TW20 9LB, ENGLAND</p>		
<p>El objeto de la declaración de conformidad es el equipo de tipo la siguiente descripción: ZM401-SD3 / SP3 ZM405-SD3 / SP3</p>		
<p>El objeto de la declaración describe anteriormente es conforme con la legislación de armonización pertinente de la Unión. Directivas aplicables / Normas armonizadas u otras especificaciones técnicas 2014/30/UE EN61000-4-2:2007 2014/35/UE EN 60950-1:2006 Modificación de la Directiva de compatibilidad electromagnética con determinadas limitaciones +A1:2010 +A12:2011 2011/65/UE EN 50581:2012</p>		
<p>Restricciones a la utilización de determinados subsistemas en el equipo de medida: No-Automático / Weighing Instruments Instrumentos de pesaje de funcionamiento automático 2014/31/UE EN 4501:2015 WELMEC 2.1</p>		
<p>El organismo notificado SGS United Kingdom Ltd. 0120 ha emitido un certificado de conformidad en virtud de la legislación de armonización pertinente de la Unión (ANEXO II, Sección 2 2014/31/UE) y expide el certificado: UK3002</p>		
<p>El organismo notificado SGS United Kingdom Ltd. 0120 ha emitido un certificado de conformidad en virtud de la legislación de armonización pertinente de la Unión (ANEXO II, Sección 2 2014/31/UE) y expide el certificado: GB95/50915</p>		
<p>Información adicional: Nota 1: ITW Ltd trading as Avery Weigh-Tronix Station Road, Egham, Surrey, TW20 9LB, England Nota 2: Esta declaración es válida solamente si el equipo de pesaje no automático ha sido verificado por el fabricante o un certificado de conformidad emitido por un organismo notificado. Firmado en nombre de: Avery Weigh-Tronix en 1000 Armstrong Drive, Fairmont, MN, 56031-1439, U.S.A. el 2017-6-22  K. Diert Innovaciones / Director de Marketing</p>		

IT	Dichiarazione di Conformità UE	Modello / Tipo: ZM4xx
<p>Nome e indirizzo del fabbricante: Avery Weigh-Tronix® Foundry Lane Smeethwick Station Road, Egham, Surrey TW20 9LB, ENGLAND</p>		
<p>Il oggetto della dichiarazione: ZM401-SD3 / SP3 ZM405-SD3 / SP3</p>		
<p>L'oggetto della dichiarazione è conforme alla legislazione armonizzata pertinente dell'Unione. Direttive applicabili / Armonizzazioni standard e altre specifiche tecniche 2014/30/UE EN61000-4-2:2007 2014/35/UE EN 60950-1:2006 Modifica della direttiva di compatibilità elettromagnetica con determinate limitazioni +A1:2010 +A12:2011 2011/65/UE EN 50581:2012</p>		
<p>Restricciones a la utilización de determinados subsistemas en el equipo de medida: No-Automático / Weighing Instruments Instrumentos de pesaje de funcionamiento automático 2014/31/UE EN 4501:2015 WELMEC 2.1</p>		
<p>El organismo notificado SGS United Kingdom Ltd. 0120 ha emitido un certificado de conformidad en virtud de la legislación de armonización pertinente de la Unión (ANEXO II, Sección 2 2014/31/UE) y expide el certificado: UK3002</p>		
<p>El organismo notificado SGS United Kingdom Ltd. 0120 ha emitido un certificado de conformidad en virtud de la legislación de armonización pertinente de la Unión (ANEXO II, Sección 2 2014/31/UE) y expide el certificado: GB95/50915</p>		
<p>Información suplementaria: Nota 1: ITW Ltd trading as Avery Weigh-Tronix Station Road, Egham, Surrey, TW20 9LB, England Nota 2: Esta declaración es válida solamente si el equipo de pesaje no automático ha sido verificado por el fabricante o un certificado de conformidad emitido por un organismo notificado. Firmado a nome e per conto de: Avery Weigh-Tronix a 1000 Armstrong Drive, Fairmont, MN, 56031-1439, U.S.A. el 2017-6-22  K. Diert Innovations / Direttore Marketing</p>		

NL	EU-Conformiteitsverklaring	Model / Type: ZM4xx
<p>Naam en adres van de fabrikant: Avery Weigh-Tronix® Foundry Lane Smeethwick Station Road, Egham, Surrey TW20 9LB, ENGLAND</p>		
<p>Deze conformiteitsverklaring wordt verstrekt onder vermelding van de volgende informatie: ZM401-SD3 / SP3 ZM405-SD3 / SP3</p>		
<p>Het beschreven apparaat is in overeenstemming met de eisen van de Europese Richtlijn betreffende de elektromagnetische compatibiliteit. Toepasselijke Richtlijn / Geharmoniseerde standaard en andere technische specificaties 2014/30/UE EN61000-4-2:2007 2014/35/UE EN 60950-1:2006 Modificatie van de Richtlijn betreffende de elektromagnetische compatibiliteit met bepaalde beperkingen +A1:2010 +A12:2011 2011/65/UE EN 50581:2012</p>		
<p>Beperkingen op het gebruik van bepaalde onderdelen in het meetapparaat: Niet-automatische weegvoorzieningen 2014/31/UE EN 4501:2015 WELMEC 2.1</p>		
<p>De afgegeven instelling SGS United Kingdom Ltd. 0120 heeft een certificaat van overeenstemming afgegeven op basis van de Europese Richtlijn betreffende de elektromagnetische compatibiliteit (ANEXO II, sectie 2 van 2014/31/UE) en het certificaat verstrekt: UK3002</p>		
<p>De afgegeven instelling SGS United Kingdom Ltd. 0120 heeft een certificaat van overeenstemming afgegeven op basis van de Europese Richtlijn betreffende de elektromagnetische compatibiliteit (ANEXO II, sectie 2 van 2014/31/UE) en het certificaat verstrekt: GB95/50915</p>		
<p>Aanvullende informatie: Nota 1: ITW Ltd trading as Avery Weigh-Tronix Station Road, Egham, Surrey, TW20 9LB, England Nota 2: Deze verklaring is alleen geldig indien het weegvoorziening niet is geïnstalleerd of gebruikt op een manier die niet is bedoeld in de afgegeven verklaring of anderszins is goedgekeurd door een bevoegde instantie. Ondertekend voor en namens: Avery Weigh-Tronix bij 1000 Armstrong Drive, Fairmont, MN, 56031-1439, U.S.A. op 2017-6-22  K. Diert Innovations / Marketing Director</p>		

FR	Declaration UE de Conformité	Modèle / Type: ZM4xx
<p>Nom et adresse du fabricant: Avery Weigh-Tronix® Foundry Lane Smeethwick Station Road, Egham, Surrey TW20 9LB, ENGLAND</p>		
<p>Objet de la déclaration: ZM401-SD3 / SP3 ZM405-SD3 / SP3</p>		
<p>L'objet de la déclaration décrit ci-dessus est conforme à la législation harmonisée de l'Union applicable. Les directives en vigueur / Les normes harmonisées ou autres spécifications techniques 2014/30/UE EN61000-4-2:2007 2014/35/UE EN 60950-1:2006 Modification de la directive de compatibilité électromagnétique avec certaines limitations +A1:2010 +A12:2011 2011/65/UE EN 50581:2012</p>		
<p>La limitation de l'utilisation de certains sous-systèmes dans l'équipement de mesure: Non-Automatique / Weighing Instruments Instrumentos de pesaje de funcionamiento automático 2014/31/UE EN 4501:2015 WELMEC 2.1</p>		
<p>L'organisme notifié SGS United Kingdom Ltd. 0120 a délivré un certificat de conformité en vertu de la législation de harmonisation pertinente de l'Union (ANNEXE II, section 2 de 2014/31/UE) et a établi le certificat: UK3002</p>		
<p>L'organisme notifié SGS United Kingdom Ltd. 0120 a délivré un certificat de conformité en vertu de la législation de harmonisation pertinente de l'Union (ANNEXE II, section 2 de 2014/31/UE) et a établi le certificat: GB95/50915</p>		
<p>Informations complémentaires: Nota 1: ITW Ltd émirant agissement sous le nom de Avery Weigh-Tronix Station Road, Egham, Surrey, TW20 9LB, England Nota 2: Cette déclaration est valide seulement si l'équipement de pesage n'a pas été installé ou utilisé d'une manière qui n'est pas prévue dans la déclaration ou autrement approuvée par une autorité compétente. Signé par et au nom de: Avery Weigh-Tronix à 1000 Armstrong Drive, Fairmont, MN, 56031-1439, U.S.A. le 2017-6-22  K. Diert Innovations / Directeur Marketing</p>		

DE	EU-Konformitätserklärung	Modell / Typen: ZM4xx
<p>Name und Adresse des Herstellers: Avery Weigh-Tronix® Foundry Lane Smeethwick Station Road, Egham, Surrey TW20 9LB, ENGLAND</p>		
<p>Das folgende Vermerkung für die Ausrichtung dieser Konformitätserklärung trifft der Hersteller: ZM401-SD3 / SP3 ZM405-SD3 / SP3</p>		
<p>Der oben beschriebene Gegenstand der Erklärung erfüllt die einschlägigen Harmonisierungsvorschriften der Union. Angewandte Richtlinien / Harmonisierte Normen oder andere technische Spezifikationen 2014/30/UE EN61000-4-2:2007 2014/35/UE EN 60950-1:2006 Modifikation der Richtlinie über die elektromagnetische Verträglichkeit mit bestimmten Einschränkungen +A1:2010 +A12:2011 2011/65/UE EN 50581:2012</p>		
<p>Beschränkungen der Verwendung bestimmter Subsysteme im Messgerät: Nicht-automatische Waagen 2014/31/UE EN 4501:2015 WELMEC 2.1</p>		
<p>Das zertifizierte SGS United Kingdom Ltd. 0120 hat ein Zertifikat der Übereinstimmung auf der Grundlage der Richtlinie über die elektromagnetische Verträglichkeit (ANHANG I Abschnitt 2 von 2014/31/UE) und dieses Zertifikat ausgestellt: UK3002</p>		
<p>Das zertifizierte SGS United Kingdom Ltd. 0120 hat ein Zertifikat der Übereinstimmung auf der Grundlage der Richtlinie über die elektromagnetische Verträglichkeit (ANHANG I Abschnitt 2 von 2014/31/UE) und dieses Zertifikat ausgestellt: GB95/50915</p>		
<p>Zusätzliche Informationen: Anmerkung 1: ITW Ltd handelt als Avery Weigh-Tronix Station Road, Egham, Surrey, TW20 9LB, England Anmerkung 2: Diese Erklärung gilt nur, wenn die nicht-automatische Waage vom Hersteller gleich wurde oder in Verbindung mit einer Konformitätsbescheinigung einer benannten Stelle. Unterschrift für und im Namen von: Avery Weigh-Tronix bei 1000 Armstrong Drive, Fairmont, MN, 56031-1439, U.S.A. am 2017-6-22  K. Diert Innovationen / Marketingdirektor</p>		

EN	EU Declaration of Conformity	Model / Type: ZM4xx
<p>Name and address of the manufacturer: Avery Weigh-Tronix® Foundry Lane Smeethwick Station Road, Egham, Surrey TW20 9LB, ENGLAND</p>		
<p>The declaration of conformity is issued under the sole responsibility of the manufacturer: ZM401-SD3 / SP3 ZM405-SD3 / SP3</p>		
<p>The object of the declaration described above is in conformity with the relevant Union harmonisation legislation. Applicable Directives / Harmonised standards and other technical specifications 2014/30/UE EN61000-4-2:2007 2014/35/UE EN 60950-1:2006 Modification of the EMC Directive with certain voltage limits +A1:2010 +A12:2011 2011/65/UE EN 50581:2012</p>		
<p>Restrictions of the use of certain subsystems in the measuring equipment: Non-Automatic Weighing Instruments WELMEC 2.1</p>		
<p>The notified body SGS United Kingdom Ltd. 0120 has issued a certificate of conformity on the basis of the EMC Directive (Section 2 of 2014/31/UE) and issued the certificate: UK3002</p>		
<p>The notified body SGS United Kingdom Ltd. 0120 has issued a certificate of conformity on the basis of the EMC Directive (Section 2 of 2014/31/UE) and issued the certificate: GB95/50915</p>		
<p>Additional information: Note 1: ITW Ltd trading as Avery Weigh-Tronix Station Road, Egham, Surrey, TW20 9LB, England Note 2: This declaration is only valid if the non-automatic weighing scale has been verified by the manufacturer or with a certificate of conformity issued by a notified body. Signed for and on behalf of: Avery Weigh-Tronix at 1000 Armstrong Drive, Fairmont, MN, 56031-1439, U.S.A. on 2017-6-22  K. Diert Innovations/Marketing Director</p>		



ES	Declaración UE de Conformidad
Modelo / Tipo: ZM4xxx (R61)	Nombre y dirección del fabricante: Avery Weigh-Tronix® Foundry Lane Snettewick Newcastle Road B66 2LP ENGLAND
	Objeto de la declaración: ZM401-SD3 / SP3 ZM405-SD3 / SP3
El objeto de la declaración descrita anteriormente es conforme con la legislación de armonización pertinente de la Unión:	La presente declaración de conformidad se otorga bajo la exclusiva responsabilidad del fabricante.
Directivas aplicables Normas armonizadas u especificaciones técnicas	2014/30/UE EN 1000-6-4:2007 Compatibilidad electromagnética 2014/53/UE EN 60950-1:2006 Múltiples directivas armonizadas con determinados límites de tensión +A1:2011 +A12:2011 2011/65/UE EN 50581:2012 Restricción de la utilización de determinadas sustancias restrictivas en el equipo electrónico 2014/32/UE OIML R61-1:2004 Instrumentos de medida (E) WELMEC 2.1 WELMEC 2.8 WELMEC 6.8 WELMEC 6.9
UK/0126/0177	El organismo notificado NMD 0126 realizó la aprobación de conformidad con la legislación de armonización de la UE y está certificado.
Información adicional:	Nota: ITW Ltd trading as Avery Weigh-Tronix China registered: Newcast House, Station Road, Egham, Surrey, TW20 9LB, England
Firmado en nombre de:	Avery Weigh-Tronix 1000 Armstrong Drive, Falmont, MN, 56031-1439, U.S.A. 2017-06-22
K.Dierit Innovations / Director de Marketing	

IT	Dichiarazione di Conformità UE
Modelo / Tipo: ZM4xxx (R61)	Nome e indirizzo del fabbricante: Avery Weigh-Tronix® Foundry Lane Snettewick Newcastle Road B66 2LP ENGLAND
	Objeto de la declaración: ZM401-SD3 / SP3 ZM405-SD3 / SP3
El objeto de la declaración descrita anteriormente es conforme con la legislación de armonización pertinente de la Unión:	La presente declaración de conformidad es otorgada bajo la exclusiva responsabilidad del fabricante.
Directiva aplicable Normas armonizadas u especificaciones técnicas	2014/30/UE EN 1000-6-4:2007 Compatibilidad electromagnética 2014/53/UE EN 60950-1:2006 Múltiples directivas armonizadas con determinados límites de tensión +A1:2011 +A12:2011 2011/65/UE EN 50581:2012 Restricción de la utilización de determinadas sustancias restrictivas en el equipo electrónico 2014/32/UE OIML R61-1:2004 Instrumentos de medida (E) WELMEC 2.1 WELMEC 2.8 WELMEC 6.8 WELMEC 6.9
UK/0126/0177	El organismo notificado NMD 0126 realizó la aprobación de conformidad con la legislación de armonización de la UE y está certificado.
Información suplementaria:	Nota: ITW Ltd trading as Avery Weigh-Tronix China registered: Newcast House, Station Road, Egham, Surrey, TW20 9LB, England
Firmado a nome e per conto de:	Avery Weigh-Tronix 1000 Armstrong Drive, Falmont, MN, 56031-1439, U.S.A. 2017-06-22
K.Dierit Innovations / Direttore Marketing	

NL	Conformiteitsverklaring
Modelo / Tipo: ZM4xxx (R61)	Naam en adres van de fabrikant: Avery Weigh-Tronix® Foundry Lane Snettewick Newcastle Road B66 2LP ENGLAND
	Objeto de la declaración: ZM401-SD3 / SP3 ZM405-SD3 / SP3
El objeto de la declaración descrita anteriormente es conforme con la legislación de armonización pertinente de la Unión:	La presente declaración de conformidad se otorga bajo la exclusiva responsabilidad del fabricante.
Directiva aplicable Normas armonizadas u especificaciones técnicas	2014/30/UE EN 1000-6-4:2007 Compatibilidad electromagnética 2014/53/UE EN 60950-1:2006 Múltiples directivas armonizadas con determinados límites de tensión +A1:2011 +A12:2011 2011/65/UE EN 50581:2012 Restricción de la utilización de determinadas sustancias restrictivas en el equipo electrónico 2014/32/UE OIML R61-1:2004 Medios de medida (E) WELMEC 2.1 WELMEC 2.8 WELMEC 6.8 WELMEC 6.9
UK/0126/0177	El organismo notificado NMD 0126 realizó la aprobación de conformidad con la legislación de armonización de la UE y está certificado.
Información suplementaria:	Nota: ITW Ltd trading as Avery Weigh-Tronix China registered: Newcast House, Station Road, Egham, Surrey, TW20 9LB, England
Firmado en nombre de:	Avery Weigh-Tronix 1000 Armstrong Drive, Falmont, MN, 56031-1439, U.S.A. 2017-06-22
K.Dierit Innovates / Marketing Director	

FR	Déclaration UE de Conformité
Modelo / Tipo: ZM4xxx (R61)	Nom et adresse du fabricant: Avery Weigh-Tronix® Foundry Lane Snettewick Newcastle Road B66 2LP ENGLAND
	Objeto de la declaración: ZM401-SD3 / SP3 ZM405-SD3 / SP3
El objeto de la declaración descrita anteriormente es conforme con la legislación de armonización de la Unión:	La présente déclaration de conformité est établie sous la seule responsabilité du fabricant.
Directives applicables Normes harmonisées ou spécifications techniques	2014/30/UE EN 1000-6-4:2007 Compatibilité Electromagnétique 2014/53/UE EN 60950-1:2006 Múltiples directivas armonizadas con determinados límites de tensión +A1:2011 +A12:2011 2011/65/UE EN 50581:2012 La limitation de l'utilisation de certaines substances restrictives dans l'équipement électronique 2014/32/UE OIML R61-1:2004 Instruments de mesure (E) WELMEC 2.1 WELMEC 2.8 WELMEC 6.8 WELMEC 6.9
UK/0126/0177	L'organisme notifié NMD 0126 a effectué l'homologation de conformité avec la législation de l'Union européenne et a délivré le certificat.
Informations complémentaires:	Notes: ITW Ltd trading as Avery Weigh-Tronix China registered: Newcast House, Station Road, Egham, Surrey, TW20 9LB, England
Signé par et au nom de:	Avery Weigh-Tronix 1000 Armstrong Drive, Falmont, MN, 56031-1439, USA 2017-06-22
K.Dierit Innovations / Directeur Marketing	

DE	EU-Konformitätserklärung
Modelo / Tipo: ZM4xxx (R61)	Name und Anschrift des Herstellers: Avery Weigh-Tronix® Foundry Lane Snettewick Newcastle Road B66 2LP ENGLAND
	Objeto de la declaración: ZM401-SD3 / SP3 ZM405-SD3 / SP3
El objeto de la declaración descrita anteriormente es conforme con la legislación de armonización pertinente de la Unión:	Die vorliegende Erklärung der Konformität ist die alleinige Verantwortung des Herstellers.
Angewandte Richtlinien Normen oder technischen Spezifikationen	2014/30/UE EN 1000-6-4:2007 Elektromagnetische Verträglichkeit 2014/53/UE EN 60950-1:2006 Elektronische Bauelemente bestimmter Spannungsebenen +A1:2011 +A12:2011 2011/65/UE EN 50581:2012 Beschränkung der Verwendung bestimmter gefährlicher Stoffe in elektrischen und elektronischen Geräten 2014/32/UE OIML R61-1:2004 Messgeräten (E) WELMEC 2.1 WELMEC 2.8 WELMEC 6.8 WELMEC 6.9
UK/0126/0177	Das notified body NMD 0126 hat die Zusammenführung der Konformitätserklärung mit der relevanten EU-Richtlinie (Richtlinie 2014/30/UE) und folgende Bescheinigung ausgestellt.
Zusatzangaben:	Anmerkung: ITW Ltd Handels als Avery Weigh-Tronix Sitz: Newcast House, Station Road, Egham, Surrey, TW20 9LB, England
Unterschiedet für und im Namen von:	Avery Weigh-Tronix 1000 Armstrong Drive, Falmont, MN, 56031-1439, USA 2017-06-22
K.Dierit Innovationen / Marketingdirektor	

EN	Declaration of Conformity
Modelo / Tipo: ZM4xxx (R61)	Name and address of the manufacturer: Avery Weigh-Tronix® Foundry Lane Snettewick Newcastle Road B66 2LP ENGLAND
	Objeto de la declaración: ZM401-SD3 / SP3 ZM405-SD3 / SP3
El objeto de la declaración descrita anteriormente es conforme con la legislación de armonización pertinente de la Unión:	The object of the declaration described above is in conformity with the relevant Union harmonisation legislation.
Applicable Directives Harmonised standards u technical specifications	2014/30/UE EN 1000-6-4:2007 Electromagnetic Compatibility 2014/53/UE EN 60950-1:2006 Electrical equipment design and safety requirements (certain voltage limits) +A1:2011 +A12:2011 2011/65/UE EN 50581:2012 Restriction of the use of certain hazardous substances in electrical and electronic equipment 2014/32/UE OIML R61-1:2004 Measuring Instruments (E) WELMEC 2.1 WELMEC 2.8 WELMEC 6.8 WELMEC 6.9
UK/0126/0177	The notified body NMD 0126 performed the approval for CE marking and issued the certificate.
Additional information:	Note: ITW Ltd trading as Avery Weigh-Tronix China registered: Newcast House, Station Road, Egham, Surrey, TW20 9LB, England
Signed for and on behalf of:	Avery Weigh-Tronix 1000 Armstrong Drive, Falmont, MN, 56031-1439, USA 2017-06-22
K.Dierit Innovations/Marketing Director	

2 Introduction

The ZM400 series indicators, shown in [Figure 2.1](#), are high performance, multi-function programmable indicators. They can display, analyze, store, and transmit data across a range of technology methods.

These indicators are suitable for the office, dusty, wet or high pressure and heavy washdown environments. They come in IP69K stainless steel desktop and IP66 panel mount housings. They have IBN displays for high contrast and a graphic array to display text and graphic messages appropriate to the function of the program.

The ZM400 indicator will support up to two scales with a maximum total of 16 - 350 ohm load cells. The standard indicator can connect to a single analog scale, an analog and digital scale or two digital scales. The indicators require 100 VAC - 240 VAC, 50 or 60 Hz or 12-36VDC. The standard indicator connectivity includes a USB Host, two serial ports and an Ethernet port.

With an option card they can support 2 analog scale inputs. Available options include:

- Analog Output
- Current Loop/RS485/RS422
- USB Device
- Wireless 802.11g
- Internal 120 VAC relay
- 2nd Scale Input 5VDC Excitation
- 2nd Scale Input 10 VDC
- External I/O Interface (for existing GSE or 1310 I/O cards)
- AC input, 4 Inputs (120-240VAC)
- DC input, 4 inputs(4-30VDC)
- AC output, 4 relays (20-240VAC)
- DC output, 4 relays (3-60VDC)

The indicator also has three logic level inputs with configurable functions and three setpoint outputs. See the Specification literature for a full list of specifications.

2.1 Front panel

The front panels, shown in [Figure 2.1](#), consists of the keys and displays.

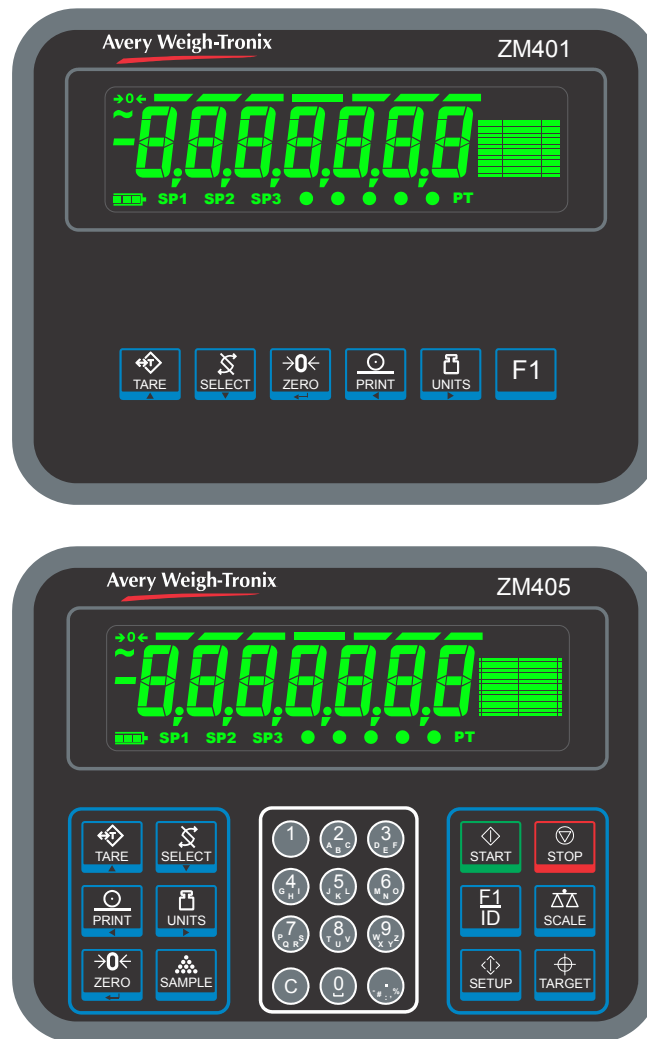







Figure 2.1 Front panels of the ZM401 and ZM405 indicators















Never press a key with anything but your finger. Damage to the overlay may result if sharp or rough objects are used.

The normal function of the keys on the front panel of the ZM401 are listed below.

	Press the TARE key to perform a pushbutton tare function. Acts as an up arrow key for menu navigation. Allows entry of numeric values.
	Press the SELECT key to toggle between the active display values. Press and hold to enter the setpoint editor. Acts as a down arrow key for menu navigation. Allows entry of numeric values.
	Press the ZERO key to zero the display. Acts as an ENTER key to accept a displayed value or function.
	Press the PRINT key to send information to a peripheral device through a configured communications port. Acts as a left arrow key for menu navigation and removes last digit during numeric entry.
	Press the UNITS key to scroll through the available units of measure while in normal operating mode. Acts as a right arrow key for menu navigation and inserts new digit during numeric entry.
	Press the F1 key to select application specific choices. Aborts a numeric entry and acts as an ESCAPE key in the menu navigation. Press and hold to view the password entry screen for menu access.

The normal function of the keys on the front panel of the ZM405 are listed below.

	Press the TARE key for pushbutton, key entry or preset Tare functions. Acts as an up arrow key for menu navigation. Allows entry of numeric values.
	Press the SELECT key to toggle between the active display values. Press and hold to enter the setpoint editor. Acts as a down arrow key for menu navigation. Allows entry of numeric values.
	Press the PRINT key to send information to a peripheral device through a configured communications port. Acts as a left arrow key for menu navigation and removes last digit during numeric entry.
	Press the UNITS key to scroll through the available units of measure while in normal operating mode. Acts as a right arrow key for menu navigation and inserts new digit during numeric entry.
	Press the ZERO key to zero the display. Acts as an ENTER key to accept a displayed value or function.
	The SAMPLE key can be used to perform custom application functions.
	The START key can be used to perform custom application functions.

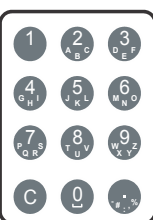
	The STOP key can be used to perform custom application functions.
	The F1/ID key can be used to perform custom application functions. It can also be used to abort a numeric entry and it acts as an ESCAPE key in the menu navigation.
	The SCALE key can be used to perform custom application functions. It can also be used to select the active scale when more than one scale is enabled.
	The SETUP key can be used to perform custom application functions. It can also be used to view the password entry screen for menu access.
	The TARGET key can be used to perform custom application functions.
	Use the numeric keypad to enter numbers in the appropriate screens. Press the C (CLEAR) key to clear the last entry.

2.1.1 Display

The display and annunciators are shown and labeled in [Figure 2.2](#).

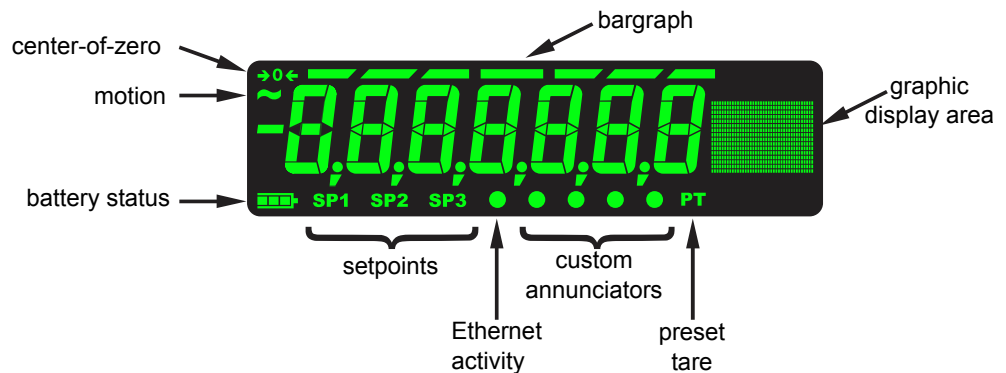

Figure 2.2 Annunciators

These annunciators will light during operation to inform the user of the weighing mode, active unit of measure, etc.

2.2 Powering up a ZM400 series indicator

The indicator is always active as long as power is received. Power can be supplied by:

- AC power cord connected to a properly grounded outlet (100 VAC - 240 VAC, 50 or 60 Hz)
- External 12VDC @ 1.2 Amps up to 36VDC @400mA (14.4 Watts). These are the power requirements for a fully loaded unit (16 x 350 load cell, 500mA out the 5V COM port terminal block, 500mA load on USB Host, and Wireless option card installed).
- AC to 24VDC power converter (optional accessory for panel mount version)
- Optional external battery pack with 4 D cells:
 - 1 x 350 ohm load cell = 6 hours battery life
 - 4 x 350 ohm load cell = 4 hours battery life
 - 8 x 350 ohm load cell = 1 hour battery life

2.3 Alphanumeric entry procedure (ZM401 only)

The keys in [Figure 2.3](#) have alternate functions in alphanumeric entry screens.

	These segments flash in numeric entry mode
TARE / ▲ -	Press to increment the flashing number
SELECT / ▼ -	Press to decrement the flashing number
PRINT / ◀ -	Press to backspace cursor in a number
UNITS / ▶ -	Press to advance cursor in a number
ZERO / ↵ -	Press to accept a value
F1 / ESC -	Press to escape an entry screen

Figure 2.3 Key function during numeric entry



When the graphic display is present you can scroll through numbers, alpha characters and symbols by repeatedly pressing the **TARE** or **SELECT** keys.

In numeric entry screens, the center segments shown in [Figure 2.3](#) flash. Use the keys, as described in [Figure 2.3](#), to enter a value on the display. Following is an example:

Example: To key in the number 507:

Repeatedly press the **TARE(↑)** or **SELECT(↓)** key until **5** appears on the display.

Press the **UNITS(→)** key once to move cursor one space to the right.

Repeatedly press the **TARE(↑)** or **SELECT(↓)** key until **0** appears on the display.

Press the **UNITS(→)** key once to move cursor one space to the right.

Repeatedly press the **TARE(↑)** or **SELECT(↓)** key until **7** appears on the display.

Press the **ZERO** key to enter or accept the value.

Press the **PRINT(←)** key to move the entry function one digit to the left. This effectively deletes the current value in that position and allows you to enter a new value in that position.

2.4 Using the alphanumeric keypad (ZM405 only)

Use the alphanumeric keypad to enter numbers and words when prompted by the indicator. The action is similar to using a cell phone to select the number or letter. A rapid succession of presses will scroll through the number on the key and then the letters, starting with upper case and then lower case. The decimal key scrolls through the negative sign, pound sign, colon, comma and percent sign. The **0** key toggles between 0 and a space.

2.5 Entering negative numbers or decimal point

To enter a minus sign for a negative number or a decimal point (or comma), press the **C** key (or **PRINT** key) to clear the current value from the display.

Then to enter a negative number, with a single **0** displayed press **SELECT**. The first character will then change to a (-) negative sign. Enter the rest of the digits normally.

To enter a decimal point (or comma), on a ZM405 use the decimal point key. On a ZM401 when the flashing digit is a 0 press the **SELECT** key and a decimal point (or comma) will appear. Then press the **UNITS** key to scroll in the next digit to follow the decimal and enter the rest of the digits normally. To enter a value less than 1 requires the entry of the leading 0 before a decimal point is allowed.

3 Indicator applications

The ZM401 indicator comes standard with a basic weighing application. The ZM405 indicator comes standard with a basic weighing application and 50 Preset Tare/ID memory. Custom applications can be written in LUA programming language or by installing Macro programs.

3.1 General weighing application

3.1.1 **SELECT** key default function

In the General Weighing application you can view the gross, net and tare display values or other scale parameters by repeatedly pressing **SELECT**.

3.1.2 **Gross weighing**



To change unit of measure, press **UNITS**.

To perform gross weighing, power up the unit and follow these steps:

1. Empty the scale and, if necessary, press **ZERO** to zero the display ...
0 is displayed and the *center-of-zero* annunciator lights.
2. Place item to be weighed on the scale ...
Weight is displayed.
3. Repeat steps 1 and 2.

3.1.3 **Net weighing**

Net weighing is available via three types of tare entry.

Pushbutton tare When enabled press **TARE** to tare the weight on the scale.

Entered tare When enabled key in a tare weight and press **TARE** to set. Not available in the ZM401.

Preset tare When enabled press **TARE** and then enter a stored Preset Tare ID (up to 4 alphanumeric digits) and press **ZERO** to set. Not available in the ZM401.

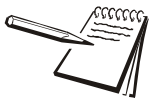

Pushbutton and Entered Tares can be enabled simultaneously. If Preset Tare is enabled, Pushbutton and Entered Tares are automatically disabled.

Auto Tare Clear

If auto tare clear is enabled, after a weighing, when the weight falls into the gross zero band, tare is cleared to zero.



Definition: Gross zero band - this is a configured value that defines a window around gross zero. This is used in several ways in different applications.

The three types of tare are explained below.

Using Pushbutton Tare

To perform a net weighing using pushbutton tare, power up the unit and follow these steps:

1. With no weight on the scale, if the display does not read **0** press **ZERO** ...
0 is displayed and the *center-of-zero* annunciator lights.
2. Place item to be tared on the scale ...
Weight is displayed.
3. Press **TARE** ...
0 is displayed and the *NET* weight is displayed.
4. Place material to be weighed into or on the tared item on the scale ...
Net weight of material is displayed.
5. Repeatedly press **SELECT** to view the gross, tare, and net values.
6. If repeated weighments use the same tared item, you do not need to establish a new tare value as described in step 2 and 3.



*Pressing **TARE** will perform the tare function but if you continue to press and hold **TARE** for 3 seconds the display will show **cLEARed** and the Tare weight is cleared.*



*If gross weight is not at 0, press the **ZERO** key; then press the **TARE** key to clear the tare value.*

Using Entered Tare (ZM405 only)

To perform a net weighing using entered tare, the following steps describe a typical operation:

1. With no weight on the scale, if the display does not read **0** press **ZERO** ...
0 is displayed and the *center-of-zero* annunciator lights.

2. Key in the tare value of the container or box that will be used to hold the material that requires a net weight value, and press **TARE ...**

Tare weight is displayed as a negative value and the *NET* weight is displayed and the PT annunciator lights.

3. Place the container or box and material to be weighed on the scale ...

Net weight of material is displayed.

4. If repeated weighments use the same tared item, you do not need to establish a new tare value as described in step 2.

5. To remove the tare weight from the scale, enter **0**, then press **TARE ...**

The tare is cleared and the scale is in gross weigh mode.



Press and hold **TARE** for 3 seconds and the display will show **cLEARed** and the Tare weight is cleared.

Using Preset Tare (ZM405 only)

Preset tares are entered in a password protected menu. Refer to details described in the [Supervisor menu \(ZM405 only\) on page 31](#). There can be up to 50 tare values stored in memory referenced by a 4 digit ID. To perform a net weighment using one of the preset tares, follow these steps:

1. With no weight on the scale, if the display does not read **0** press **ZERO ...**

0 is displayed and the *center-of-zero* annunciator lights.

2. Press **TARE ...**

EntEr is displayed.

3. Key in the desired preset tare ID and press **ZERO ...**

Tare weight is displayed as a negative value and the net weight is displayed and the PT annunciator lights.

4. Place container or box and material to be weighed on the scale ...

Net weight of material is displayed.

Step 4 can be done prior to step 2 if desired.

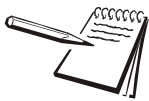

When the item is removed from the scale the Tare is cleared automatically if Auto Tare Clear is enabled. To remove the tare weight manually, select a preset tare ID that has a value of 0 for the tare.



If the active unit of measure is lb-oz then tare weights must be entered in the oz equivalent. To enter 2 lb 4.5 oz you would need to enter 36.5 oz (2 lb = 32 oz plus the 4.5)

3.1.4 Using setpoints

Setpoints are values (weight) at which outputs are triggered automatically. Outputs can control relays connected to valves, lights, other machinery, or used in applications for status or conditional settings to impact the way the indicator operates. Setpoint outputs can be configured in the Ztools configurator program.

The default application is configured for the three onboard Outputs to Activate Above a Gross Weight Value. Hold the SELECT key to access the setpoint editor.

The three onboard inputs are setup for:

- 1 = Zero
- 2 = Tare
- 3 = Print

3.1.5 Printing

What is printed is typically controlled by the custom application program. The default application program will print the gross, tare and net weight on serial port 1 when you press **PRINT**.

Printing any of the configured print formats is possible using the Numbered Print feature. Enter the print format number and then press the **PRINT** key. The selected print format will be transmitted out all ports that are configured to print.

4 Menus

Password protected menus are available to configure the indicator and/or view information.

4.1 Accessing the menus

Follow these steps to access the menus in the ZM400 series.

1. With the indicator powered up and in normal operating mode, press and hold **SETUP** on the ZM405 and **F1** on the ZM401 ...

Pass is displayed, prompting you to enter the password.

2. Key in the password for the menu you want and press the **ZERO** key ...

The first item in the top level of the menu you accessed is displayed.

3. Use the navigation keys, shown below, to navigate through the menu structure. The symbols in the chart appear on the bottom of the keys.

Press **SELECT**/ ▼ to move down in a menu
 Press **TARE**/ ▲ to move up in a menu, except at the bottom item in a menu, then use **ZERO**/ ↵ or **F1**
 Press **PRINT**/ ◀ to move left in a menu
 Press **UNITS**/ ▶ to move right in a menu
 Press **ZERO**/ ↵ to accept a value or choice and move up in the menu.
 Press **F1** to escape and move up in the menu

4.2 Menu annunciators

The menu structure is made up of menu items, parameters, value entry screens and lists from which you choose one item. To help you know where you are in the menu, the bargraph at the top of the display is on while the indicator is in the menus and will change appearance according to the following rules:

All segments flashing	This means you are in the menu structure but not in any of the following screens.
Center flashing / others solid	This means you are in a parameter prompt screen.
Center flashing / others off	This means you are in a numeric entry screen. Enter a number and press ZERO to accept.
Right flashing / others off	This means you are in a list. Scroll through the choices with the PRINT and UNITS keys and press ZERO to accept.

4.3 Exiting the menus

1. If you are at the bottom item in a menu use **ZERO** to accept a choice or value and move up a level, or use **SETUP** on the ZM405 or **F1** on the ZM401 to escape and move up one level without accepting the choice or value. From that point, press **TARE** repeatedly until ...

SAVE no is displayed. This means "Do not save changes."

2. Press **UNITS** to scroll through the choices: **SAVE no**, **SAVEYES** and **CAnCEL**. Press **ZERO** to accept the displayed choice.

If you choose **SAVE no** or **SAVEYES** the indicator exits the menu and returns to normal weighing mode.

OR

If you choose **CAnCEL**, the indicator remains in the menu.

4.4 USER level menus

The USER level menus are available to the user. The other menu levels are for supervisors and technicians only.

The USER level (password 111) contains the User, About, and Audit menus arranged as shown in [Figure 4.1](#).

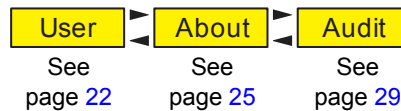

Figure 4.1 USER level (password 111) menus

To access the USER level, from normal weighing mode, press and hold the **F1** key. Enter password 111 and press the **ZERO** key.

4.5 User menu

The User menu is shown in Figure 4.2.

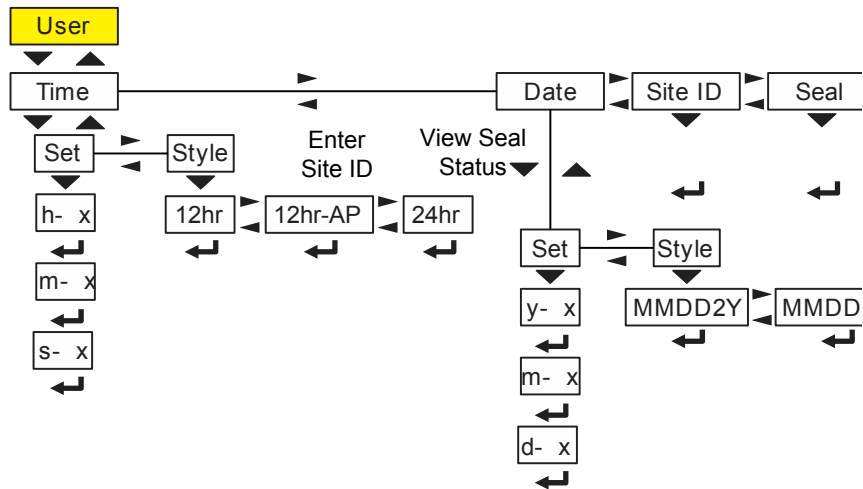
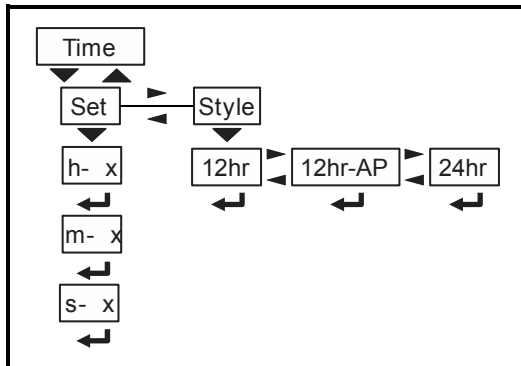

Figure 4.2 User menu

Use this menu to set the time and date, to enter a site ID, and view the physical seal status. Each is explained below:

4.5.1 Time



Use the **tiME** menu item to set the clock (**SEt**) and to choose the style of the time display (**StYLE**) 12 hr, 12 hr AM/PM or 24 hr.



The Time and Date can be used in print formats.

SEt Use this to enter values for the time.

h- x, = Hour

m- x = Minute

s- x = Seconds

StYLE Choose the style of the time display. Choices are:

12hr, = 12 hour clock

12hr-AP = 12 hour clock with AM/PM

24hr = 24 hour military time

4.5.2 Date

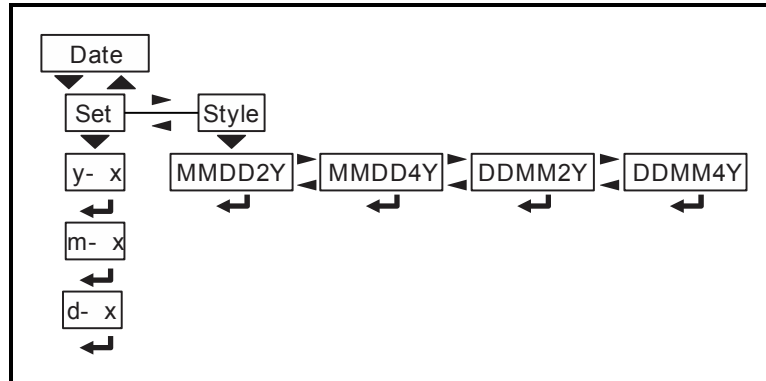

Use the **dAtE** item to set the year, month and day and the style of the displayed date.

SEt Enter values for the date.

y- x = Year

m- x = Month

d- x = Day

StYLE Choose the style of the date display. Choices are:
MMdd2Y = Month, Day, 2-digit Year
MMdd4Y = Month, Day, 4-digit Year
ddMM2Y = Day, Month, 2-digit Year
ddMM4Y = Day, Month, 4-digit Year

4.5.3 Site ID

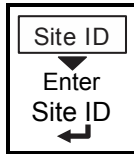

SitE

Use this to enter a Site ID. Enter up to 6 characters for the Site ID via the alphanumeric entry. See page 14.

The Site ID can be used in a print format. Valid entries are decimal 32 through 126 (ASCII space to the ~ character)

4.5.4 Seal

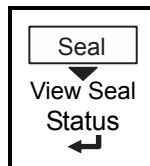

SEAL

Use this to view the seal status of the indicator.

This is the status of the physical seal jumper inside the indicator. If the unit is sealed, no changes can be made to the configuration of the indicator.

To exit the menu, see *Exiting the menus on page 21*.

4.6 About menu

The About menu is shown in [Figure 4.3](#).

Reference *Alphanumeric entry procedure*

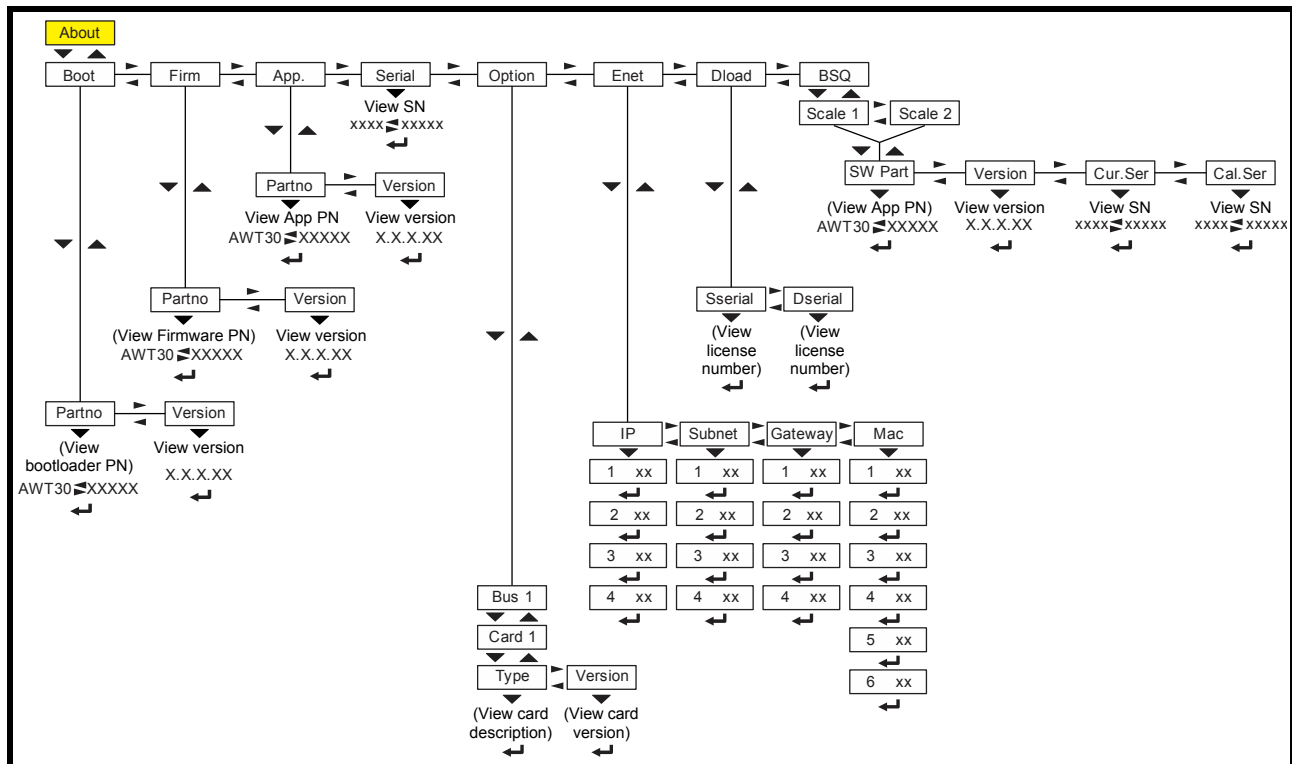

Figure 4.3 About menu

Use this menu to display information about the various items shown in [Figure 4.3](#). Each is explained below:



Definitions:

Bootloader Software that makes the electronics run.

Firmware Embedded system software that creates core functions of the product.

App Specific software that controls the behaviour for a given installation.

4.6.1 Boot (Bootloader)

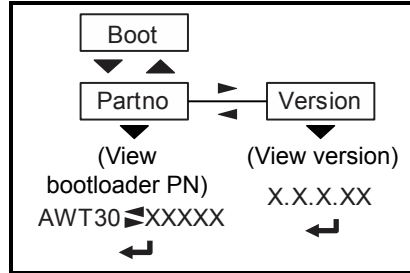

Partno Use this to view the bootloader part number. The part number is displayed in two parts. Press **RIGHT arrow** key or **LEFT arrow** key to toggle the display between the first and second parts of the part number.

VERsion Use this to view the version of the bootloader.

4.6.2 Firmware

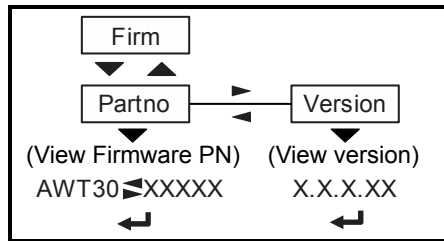

Partno Use this to view the firmware part number. The part number is displayed in two parts. Press **RIGHT arrow** key or **LEFT arrow** key to toggle the display between the first and second parts of the part number.

VERsion Use this to view the version of the firmware.

4.6.3 App

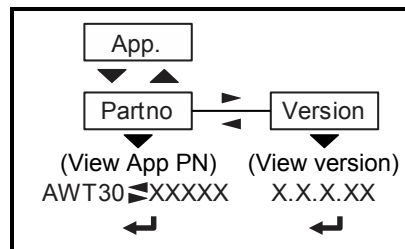

Partno Use this to view the App part number. The part number is displayed in two parts. Press **RIGHT arrow** key or **LEFT arrow** key to toggle the display between the first and second parts of the part number.

VERsion Use this to view the version of the App.

4.6.4 Serial

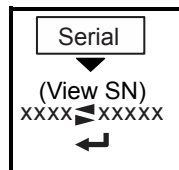

SERIAL Use this to view the Serial Number of the indicator. The number is displayed in two parts. Press **RIGHT arrow** key or **LEFT arrow** key to toggle the display between the first and second parts of the serial number.

4.6.5 Option

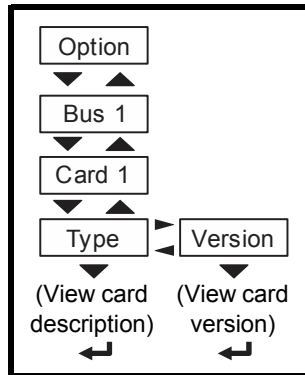

Bus 1 There is only 1 Bus in the ZM400.

Card 1 There is only 1 Card in the ZM400.

oPtion Use this to view the description and version of an installed option card.

4.6.6 Enet

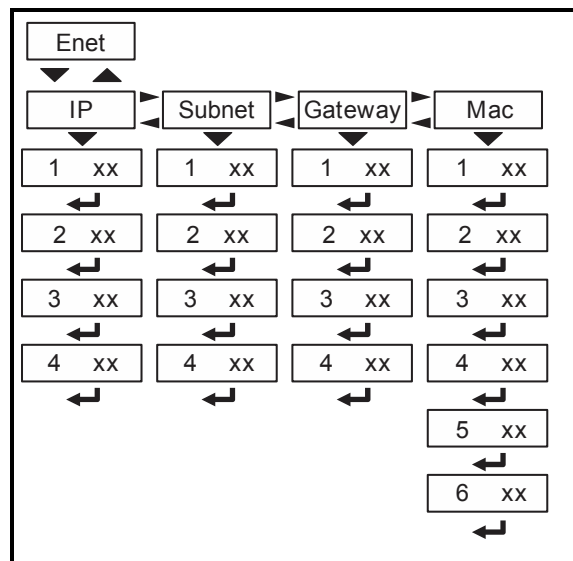

EnEt This stands for Ethernet. Use this to view the network addresses.



If the indicator is connected to an Ethernet network, the values displayed will be the current assigned addresses.

iP Use this to view the IP address.

SubnEt Use this to view the Subnet address.

gAtEWAY Use this to view the Gateway address.

MAc Use this to view the Mac address.



The IP, Subnet and Gateway addresses are a series of four double digit values.

The MAC address is a series of six double digit values: 1 XX, 2 XX, 3 XX, etc.

4.6.7 Download

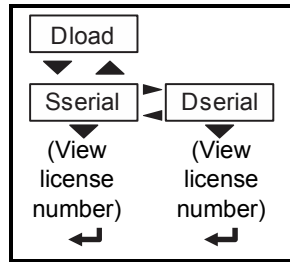

dLoAd

This stands for download. Use this to view these items:

SSEriAL View the license number that created the configuration file.

dSEriAL View the license number that downloaded the configuration file.

This is used for security and licensing purposes.



To upload a configuration file, the license number of the Configurator (Ztools) software must match one of the license numbers in the indicator Contact AWTX Technical Support for assistance.

4.6.8 BSQ

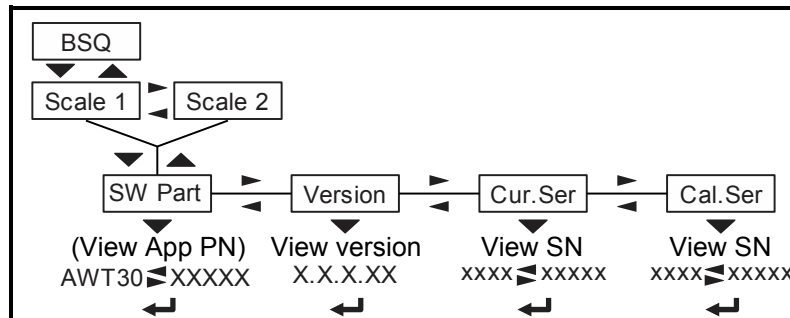

This stands for Bench Scale - Quartzell.

SW Part View the firmware part number of the cell that is connected.

VERsion View the firmware version of the cell that is connected.

cur.SER View the serial number of the cell that is connected.

cAL.SER View the serial number of the cell that **WAS** connected at the time of calibration.

To exit the menu, see *Exiting the menus on page 21*.

4.7 Audit menu

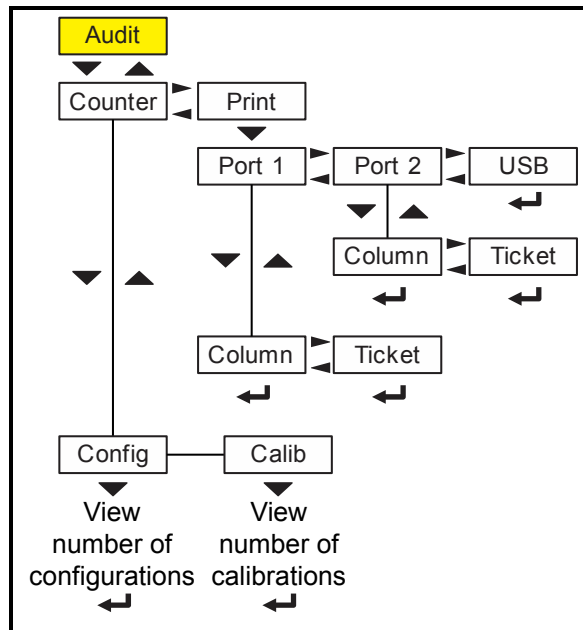
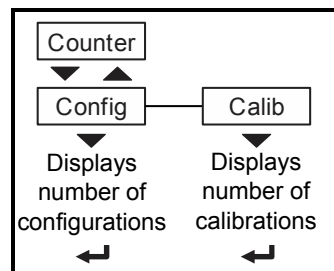

Figure 4.4 Audit menu

Use this menu to display audit counters for configuration and calibration and to print the information. Each is explained below:

4.7.1 Counter



countEr

Use this to view these items:

conFig

View how many times the indicator has been configured.

cALib

View how many times the indicator has been calibrated.

4.7.2 Print

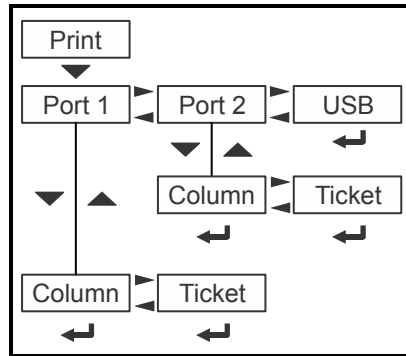

Print Use these to select which port to print the audit report through. Choices are:

Port 1 Under **Port 1** choose to print to a column or ticket printer.

Port 2 Under **Port 2** choose to print to a column or ticket printer.

uSb Printing to USB requires that a USB flash drive is connected to the indicator host USB. Printing to USB will create a folder on the flash drive and a comma separated file with the data.

To exit the menu, see *Exiting the menus on page 21*.

5 Supervisor menu (ZM405 only)

The Supervisor menu allows the setup and editing of the Preset Tare register in the ZM405. This menu only applies to the default standard application of the ZM405 indicator.

To access the Supervisor menu requires entry of the Supervisor password. Refer to the Service manual for details. The ZM405 has a Preset Tare register memory which can store 50 tares, each identified by a 4 digit alphanumeric Tare ID. Preset Tare must be enabled for these settings to function.

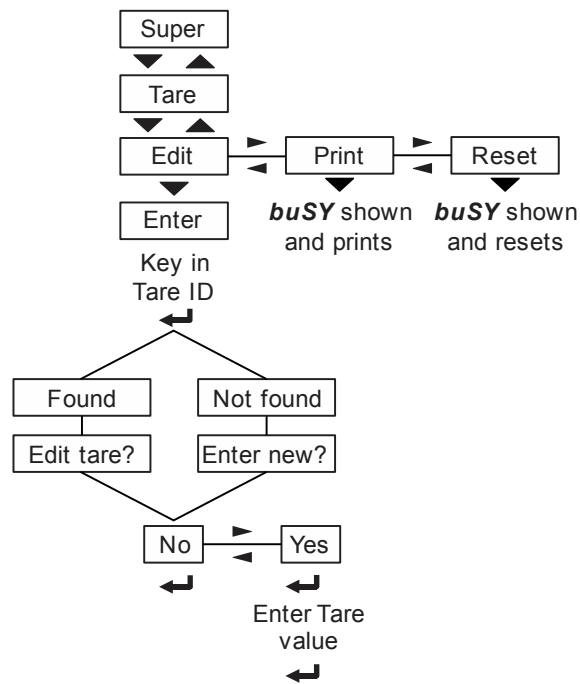

Figure 5.1 Supervisor menu

Enter the Supervisor password. Follow the keypresses illustrated in [Figure 5.1](#) and see the definitions of each item below to enter, print or reset the 50 available Preset Tares, which include the ID number and the tare weight.

SuPEr This is the top item in the Supervisor menu.

tArE This is the only item to appear in the Supervisor menu. Use this to manage the Preset Tares.

EdIt Use this to find an existing tare or create a new one

PrInT Use this to print the tare list. See *Printed Preset Tare report example on page 33*.

rESEt Use this to clear all tares in memory.

For step by step instructions see the following sections.

5.1 Creating a new Preset Tare

1. From **Edit** press **SELECT** ...
EntEr is displayed. A cursor appears in the graphic display box on the right side of the display.
2. Enter up to 4 alphanumeric digits for the Preset Tare ID. The digits will appear in the graphic display. Press **ZERO** to accept ...
Since this is a new Preset Tare the display will quickly scroll through these messages: **not Found** and then **EntEr nEW?** followed by **no**.
3. Press **UNITS** ...
YES is displayed.
4. Press **ZERO** ...
A flashing **0** is displayed and the instruction **Enter Tare** appears in the graphic display.
5. Key in the Preset Tare weight and press **ZERO** to accept ...
The display returns to the **Edit** menu item. The Preset Tare is now in memory and can be recalled.

5.2 Editing an existing Preset Tare

1. From **Edit** press **SELECT** ...
EntEr is displayed. A cursor appears in the graphic display box on the right side of the display.
2. Enter the Preset Tare ID number. The digits will appear in the graphic display. Press **ZERO** to accept ...
Since this is an existing Preset Tare the display will quickly scroll through these messages: **Found** and then **Edit tArE?** followed by **no**.
3. Press **UNITS** ...
YES is displayed.
4. Press **ZERO** ...
A flashing display of the current tare value is displayed and the instruction **Enter Tare** appears in the graphic display.
5. Key in the new Preset Tare weight and press **ZERO** to accept ...
The display returns to the **Edit** menu item. The new Preset Tare value is now in memory and can be recalled.

5.3 Printing the Preset Tare list

1. From **Edit** press **UNITS** ...
Print is displayed.

2. Press **SELECT** ...

bUSY is briefly displayed as the Preset Tare report is printed. See *Printed Preset Tare report example on page 33*. The display returns to the **Print** menu item.

5.4 Resetting the Preset Tare list

1. From **Edit** press **UNITS** twice ...

rESet is displayed.

2. Press **SELECT** to reset the Preset Tare memory to factory defaults ...

bUSY is briefly displayed as the Preset Tare memory is cleared and then the display returns to the **rESet** menu item.



If the Preset Tare list has been reset and you print the Preset Tare report the 50 memory channels will be listed but the Tare Name and Tare Value will each be 0.

5.5 Printed Preset Tare report example

List of Preset Tares

```
-----
Tare Name: Tare Value:
1      12AB      10
2      23BC      20
3      34CD      30
4      45DE      40
5      56EF      50
6      67FG      60
7      78GH      70
8      89HI      80
9      90IJ      90
10     123A      100
11     234B      110
12     345C      120
13     456D      130
14     567E      140
15     678F      150
16     789G      160
17     890H      170
18     ABCD      180
19     BCDE      190
20     CDEF      200
21     1234      210
22     2345      220
23     3456      230
24     4567      240
25     5678      250
26     6789      260
27     7890      270
28     ABCD      280
29     BCDE      290
```

Etc. to 50

Tare List Complete

6 Communications

The ZM400 can communicate through these ports:

- Serial (2)
- Ethernet
- USB-Host (transactions to USB memory stick or compatible USB printer)
- Option Cards
 - USB-Device
 - Wireless 802.11g
 - RS485/20ma current loop

6.1 Default print formats

Below are examples of the default formats that are available:

General Weighing (Format #1)

```
~~~~~  
Gross  272.04 lb  
Tare   95.88 lb  
Net    176.16 lb  
~~~~~
```

Active value (G, T or N) and displayed weight (Format #5)

```
~~~~~  
G  272.04 lb  
~~~~~
```









Displayed weight and active value (G, T or N) (Format #7)

```
~~~~~  
272.04 lb G  
~~~~~
```

The indicator can be configured for many other outputs to match the application.

7 Error messages

The following error messages may be displayed during use of the indicator:

Message	Display
Overload	
Can't fit on display	
Underload	
Can't	
Entry not in valid range	
Password entry failed	
Indicator did not reach a stable zero weight within time window set for automated weighing process.	  

Avery Weigh-Tronix



Avery Weigh-Tronix USA

1000 Armstrong Dr.

Fairmont MN 56031 USA

Tel:507-238-4461

Fax:507-238-4195

Email: usinfo@awtxglobal.com

www.averyweigh-tronix.com

Avery Weigh-Tronix UK

Foundry Lane,

Smethwick, West Midlands,

England B66 2LP

Tel:+44 (0) 8453 66 77 88

Fax:+44 (0)121 224 8183

Email: info@awtxglobal.com

www.averyweigh-tronix.com